

iW-RainboW-G24M Arria10 SoC/FPGA SOM Hardware User Guide



Document Revision History

Document Number		iW-PRFAZ-UM-01-R4.0-REL1.0-Hardware
Revision	Date	Description
1.0	04 th April 2023	Initial Release Version

PROPRIETARY NOTICE: This document contains proprietary material for the sole use of the intended recipient(s). Do not read this document if you are not the intended recipient. Any review, use, distribution or disclosure by others is strictly prohibited. If you are not the intended recipient (or authorized to receive for the recipient), you are hereby notified that any disclosure, copying distribution or use of any of the information contained within this document is STRICTLY PROHIBITED. Thank you. "iWave Systems Tech. Pvt. Ltd."

Disclaimer

iWave Systems reserves the right to change details in this publication including but not limited to any Product specification without notice.

No warranty of accuracy is given concerning the contents of the information contained in this publication. To the extent permitted by law no liability (including liability to any person by reason of negligence) will be accepted by iWave Systems, its subsidiaries or employees for any direct or indirect loss or damage caused by omissions from or inaccuracies in this document.

CPU and other major components used in this product may have several silicon errata associated with it. Under no circumstances, iWave Systems shall be liable for the silicon errata and associated issues.

Trademarks

All registered trademarks, product names mentioned in this publication are the property of their respective owners and used for identification purposes only.

Certification

iWave Systems Technologies Pvt. Ltd. is an ISO 9001:2015 Certified Company.



Warranty & RMA

Warranty support for Hardware: 1 Year from iWave or iWave's EMS partner.

For warranty terms, go through the below web link,

<http://www.iwavesystems.com/support/warranty.html>

For Return Merchandise Authorization (RMA), go through the below web link,

<http://www.iwavesystems.com/support/rma.html>

Technical Support

iWave Systems technical support team is committed to provide the best possible support for our customers so that our Hardware and Software can be easily migrated and used.

For assistance, contact our Technical Support team at,

Email : support.ip@iwavesystems.com

Website : www.iwavesystems.com

Address : iWave Systems Technologies Pvt. Ltd.
7/B, 29th Main, BTM Layout 2nd Stage,
Bangalore, Karnataka,
India – 560076

Table of Contents

1. INTRODUCTION	7
1.1 Purpose	7
1.2 Overview	7
1.3 List of Acronyms.....	7
1.4 Terminology Description.....	8
1.5 References	8
2. ARCHITECTURE AND DESIGN	9
2.1 Arria10 SoC/FPGA SOM Block Diagram	9
2.2 Arria10 SoC/FPGA SOM Features.....	10
2.3 Arria10 SoC/FPGA	12
2.3.1 Arria10 SoC/FPGA Power	14
2.3.2 Arria10 SoC/FPGA Reset	14
2.3.3 Arria10 SoC/FPGA Reference Clocks.....	15
2.3.4 Arria10 SoC/FPGA Configuration Scheme.....	16
2.3.5 Arria10 SoC/FPGA High Speed Transceivers	17
2.4 PMIC.....	17
2.5 Memory.....	18
2.5.1 DDR4 SDRAM with ECC for HPS/FPGA	18
2.5.2 DDR4 SDRAM for FPGA	18
2.5.3 MicroSD Connector for HPS booting.....	18
2.5.4 eMMC Flash for HPS booting (Optional).....	19
2.5.5 Configuration Flash for FPGA	19
2.6 On-SOM Features.....	20
2.6.1 JTAG Header.....	20
2.6.2 Fan Header	22
2.6.3 FPGA AS Header	23
2.7 Board to Board Connector1 Interfaces	25
2.7.1 FPGA High Speed Transceivers.....	29
2.7.2 FPGA IOs & General Purpose Clocks – Bank2A	33
2.7.3 FPGA IOs & General Purpose Clocks – Bank3A	36
2.8 Board to Board connector2 Interfaces.....	41
2.8.1 HPS Interfaces	45
2.8.2 FPGA Interfaces.....	51
2.9 Arria10 SoC HPS Pin Multiplexing on Board to Board Connector2.....	62
3. TECHNICAL SPECIFICATION	65
3.1 Electrical Characteristics	65
3.1.1 Power Input Requirement.....	65
3.1.2 Power Input Sequencing	66
3.1.3 Power Consumption.....	67
3.2 Environmental Characteristics	68

3.2.1	Environmental Specification	68
3.2.1	RoHS2 Compliance	68
3.2.2	Electrostatic Discharge.....	68
3.2.3	Heat Sink	68
3.3	Mechanical Characteristics	70
3.3.1	Arria10 SoC/FPGA SOM Mechanical Dimensions	70
3.3.2	Guidelines to insert the Arria10 SoC/FPGA SOM into Carrier board	72
4.	ORDERING INFORMATION	73
5.	APPENDIX I	74
5.1	Arria10 SoC/FPGA SOM Development Platform.....	74

List of Figures

Figure 1: Arria10 SoC/FPGA SOM Block Diagram	9
Figure 2: Arria10 SoC Simplified Block Diagram	12
Figure 3 Arria10 Family Device Comparison	13
Figure 4: Micro SD Connector	19
Figure 5: JTAG Header.....	20
Figure 6: Fan Header	22
Figure 7: FPGA AS Header	23
Figure 8: Board to Board Connector1	25
Figure 9: Board to Board Connector2	41
Figure 11: Power Input Sequencing	66
Figure 10: Heat Sink Dimensions	69
Figure 12: Mechanical dimension of Arria10 SoC/FPGA SOM- Top View.....	70
Figure 13: Mechanical dimension of Arria10 SoC/FPGA SOM- Bottom View.....	71
Figure 14: Mechanical dimension of Arria10 SoC/FPGA SOM- Side View	71
Figure 15: Arria10 SoC/FPGA SOM Insertion procedure	72
Figure 16: Arria10 SoC/FPGA SOM Development Platform.....	74

List of Tables

Table 1: Acronyms & Abbreviations.....	7
Table 2: Terminology	8
Table 3: Arria10 SoC/FPGA SOM Reference Clocks	15
Table 4: Configuration Selection Switch Truth Table.....	16
Table 5: Arria10 SoC/FPGA Transceiver data rate performance	17
Table 6: JTAG Header Pin Assignment	21
Table 7: FAN Header Pin Assignment.....	22
Table 8: FPGA AS Header Pin Assignment	23
Table 9 Board to Board Connector1 Pinout.....	26
Table 10: Board to Board Connector2 Pinout.....	42
Table 11: Arria10 SoC HPS IOMUX on Board to Board Connector2.....	62
Table 12: Power Input Requirement.....	65
Table 13: Power Sequence Timing.....	66
Table 14: Power Consumption.....	67
Table 15: Environmental Specification	68
Table 16: Orderable Product Part Numbers	73

1. INTRODUCTION

1.1 Purpose

This document is the Hardware User Guide for the Arria10 SoC/FPGA System On Module based on the Intel's Arria10 SoC or FPGA. This board is fully supported by iWave Systems Technologies Pvt. Ltd. This Guide provides detailed information on the overall design and usage of the Arria10 SoC/FPGA SOM from a Hardware Systems perspective.

1.2 Overview

The Arria10 SoC/FPGA SOM is an extension of Arria10 SoC/FPGA. The Arria10 SoC/FPGA SOM has a form factor of 95mm x 75mm and provides the functional requirements for an embedded application. Two 240pin high speed ruggedized terminal strip connectors provide the carrier board interface to carry all the I/O signals to and from the Arria10 SoC/FPGA SOM.

1.3 List of Acronyms

The following acronyms is used throughout this document.

Table 1: Acronyms & Abbreviations

Acronyms	Abbreviations
ARM	Advanced RISC Machine
AS	Active serial
CPU	Central Processing Unit
DDR4 SDRAM	Double Data Rate fourth-generation Synchronous Dynamic Random Access Memory
DMA	Direct Memory Access
FPGA	Field Programmable Gate Array
FPP	Fast Passive Parallel
GB	Giga Byte
Gbps	Gigabits per sec
GHz	Giga Hertz
GPIO	General Purpose Input Output
HPS	Hard Processor System
I2C	Inter-Integrated Circuit
JTAG	Joint Test Action Group
Kbps	Kilobits per second
MAC	Media Access Controller
MB	Mega Byte
Mbps	Megabits per sec
MHz	Mega Hertz
PCB	Printed Circuit Board
PMIC	Power Management Integrated IC

Acronyms	Abbreviations
PS	Passive Serial
ROHS	Restriction of Hazardous Substances
SPI	Serial Peripheral Interface
SD	Secure Digital
SoC	System On Chip
SOM	System On Module
UART	Universal Asynchronous Receiver/Transmitter
USB	Universal Serial Bus
USB OTG	USB On The Go

1.4 Terminology Description

In this document, wherever Signal Type is mentioned, below terminology is used.

Table 2: Terminology

Terminology	Description
I	Input Signal
O	Output Signal
IO	Bidirectional Input/output Signal
CMOS	Complementary Metal Oxide Semiconductor Signal
DIFF	Differential Signal
LVC MOS	Low Voltage Complementary Metal Oxide Semiconductor Signal
LVDS	Low Voltage Differential Signal
OD	Open Drain Signal
OC	Open Collector Signal
Power	Power Pin
PU	Pull Up
PD	Pull Down
NA	Not Applicable
NC	Not Connected

Note: Signal Type does not include internal pull-ups or pull-downs implemented by the chip vendors and only includes the pull-ups or pull-downs implemented On-SOM.

1.5 References

- Arria10 Device Handbook
- Arria10 Device Overview

2. ARCHITECTURE AND DESIGN

This section provides detailed information about the Arria10 SoC/FPGA SOM features and Hardware architecture with high level block diagram. Also this section provides detailed information about two Board to Board connector's pin assignment and usage.

2.1 Arria10 SoC/FPGA SOM Block Diagram

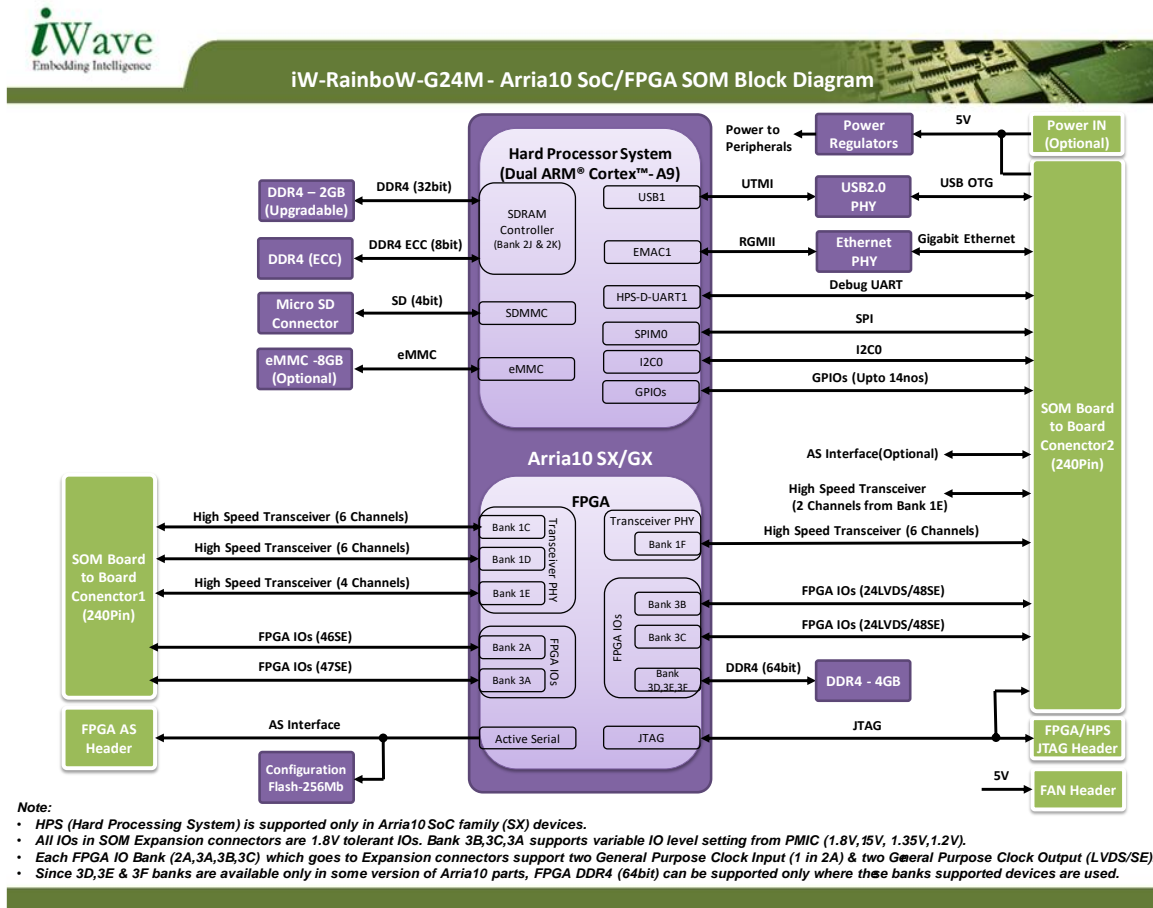

Figure 1: Arria10 SoC/FPGA SOM Block Diagram

2.2 Arria10 SoC/FPGA SOM Features

The Arria10 SoC/FPGA SOM supports the following features.

SoC/FPGA

- Intel's Arria10 SoC/FPGA
 - Compatible Arria10 SoC Family - SX270, SX320, SX480, SX570, SX660
With upto 660K Logic Elements, 24 High Speed Transceivers and integrated Dual Core ARM Cortex –A9 @ upto 1.5 GHz/Core Hard Processor System (HPS).
 - Compatible Arria10 FPGA Family - GX270, GX320, GX480, GX570, GX660, GX900, GX1150
With upto 1150K Logic Elements and 24 High Speed transceivers
- FPGA Configuration Selection Switch

Memory

- 2GB DDR4 SDRAM (32bit) with ECC for HPS (Expandable) ^{1,2}
- 4GB DDR4 RAM (64bit) from FPGA ³
- MicroSD Connector for HPS booting ^{1,4}
- eMMC Flash for HPS booting (Optional) ^{1,4}
- Configuration Flash for FPGA

Other On-SOM Features

- JTAG Header
- FAN Header
- FPGA AS Header

Board to Board Connector1 Interfaces

- FPGA High Speed Transceivers (upto 17.4Gbps) x 16
- FPGA IOs & General Purpose Clocks - Bank2A
 - Upto 21 LVDS/46SE IOs
 - One General Purpose Clock Input LVDS Pair/Single Ended
 - Two General Purpose Clock Output LVDS Pairs/Single Ended
- FPGA IOs & General Purpose Clocks – Bank3A
 - Upto 22 LVDS/47SE IOs
 - Two General Purpose Clock Input LVDS Pairs/Single Ended
 - Two General Purpose Clock Output LVDS Pairs/Single Ended

Board to Board Connector² Interfaces

From HPS Block: ^{1,5}

- Gigabit Ethernet x 1 Port (through On-SOM Gigabit Ethernet PHY)
- USB OTG x 1 Port (through On-SOM USB ULPI PHY)
- HPS Dedicated Debug UART (UART1) x 1 Port
- SPI x 1 Port
- I2C x 1 Port
- HPS GPIOs
- HPS Warm Reset

From FPGA Block:

- FPGA High Speed Transceivers (upto 17.4Gbps) x 8
- FPGA IOs & General Purpose Clocks – Bank3B
 - Upto 24 LVDS IOs
 - Two General Purpose Clock Input LVDS Pairs/Single Ended
 - Two General Purpose Clock Output LVDS Pairs/Single Ended
- FPGA IOs & General Purpose Clocks – Bank3C
 - Upto 24 LVDS IOs
 - Two General Purpose Clock Input LVDS Pairs/Single Ended
 - Two General Purpose Clock Output LVDS Pairs/Single Ended
- JTAG Interface

General Specification

- Power Supply : 5V
- Form Factor : 95mm x 75mm

¹ In Arria10 SoC/FPGA SOM, these interfaces can be supported only if Arria10 “SoC” family devices are used which supports Hard Processor System (HPS).

² In Arria10 SoC/FPGA SOM, if Arria10 SoC family device is not used and FPGA family device is used, then also 32bit DDR4 can be supported from FPGA fabric.

³ This FPGA DDR4 interface is not supported in lower device configurations of Arria10 SoC/FPGA devices (SX270, GX270, SX320 and GX320) based SOM.

⁴ In Arria10 SoC/FPGA SOM, these interfaces can be supported only if Arria10 “SoC” family devices are used because these interfaces are supported through Dedicated I/O pins of Hard Processor System (HPS).

⁵ In Arria10 SoC/FPGA SOM, if Arria10 “SoC” family device is not used and “FPGA” only family device is used, then these Shared I/O interfaces cannot be used. But the same pins can be used as FPGA Bank2L from FPGA fabric.

2.3 Arria10 SoC/FPGA

The Arria10 SoC/FPGA SOM is based on Intel's Arria10 family devices with F34 package (1,152 pins, 35 mm x 35 mm). Intel's Arria10 family devices comes with FPGA alone devices and FPGA + HPS supported devices (which is called as SoC). The Arria10 SoC/FPGA comes with three different FPGA fabric speed grade supported devices and different power options. Also its high speed transceivers comes with four different speed grade supported devices.

The Arria10 SoC devices supports Dual Core ARM Cortex-A9 core up to 1.5 GHz speed/core. The Dual ARM Cortex-A9 core with FPGA fabric allows greater flexibility for the system designers and helps lower the system cost and power consumption. This improved logic integration with a rich feature set of embedded peripherals, hardened floating point variable precision DSP blocks, embedded high speed transceivers, hard memory controllers and protocol intellectual property controllers which is ideal for cost-sensitive high end applications. The Block Diagram of Arria10 SoC from the datasheet is shown below for reference.

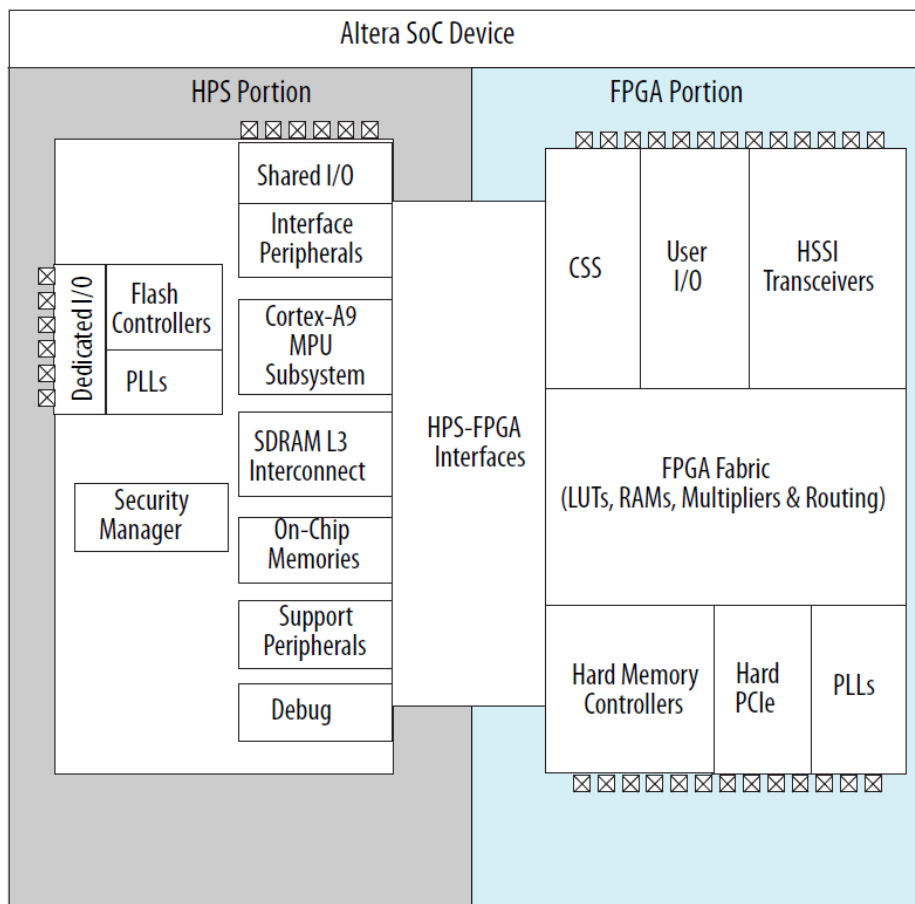

Figure 2: Arria10 SoC Simplified Block Diagram

Note: Please refer the latest Arria10 SoC/FPGA datasheet from Intel website for Electrical & Switching characteristics which may be revised from time to time.

Arria10 SoC/FPGA SOM Hardware User Guide

The Arria10 SoC/FPGA SOM is compatible to SX270 SX480, and SX660 devices and feature comparison between these devices are shown below.

PRODUCT LINE		SX270	SX480	SX660
Resources	LEs (K)	270	480	660
	System logic elements (K)	354	629	865
	Adaptive logic modules (ALMs)	101,620	181,790	250,540
	Registers	406,480	727,160	1,002,160
	M20K memory blocks	750	1,438	2,133
	M20K memory (Mb)	15	28	42
	MLAB memory (Mb)	2.4	4.3	5.7
	Hardened single-precision floating-point multipliers/adders	830/830	1,368/1,368	1,688/1,688
	18 x 19 multipliers	1,660	2,736	3,376
	Peak fixed-point performance (GMACS) ¹	1,826	3,010	3,714
Peak floating-point performance (GFLOPS)	747	1,231	1,519	
Clocks, Maximum I/O Pins, and Architectural Features	Global clock networks	32	32	32
	Regional clocks	8	8	16
	Hard processor system (available in SX devices only)	Dual-core Arm Cortex-A9 MPCore processor		
	Maximum LVDS channels (1.6 G)	168	222	270
	Maximum user I/O pins	384	492	696
	Transceiver count (17.4 Gbps)	24	36	48
	Transceiver count (25.78 Gbps)	–	–	–
	PCIe* hardened IP blocks (Gen3 x8) ²	2	2	2
Maximum 3 V I/O pins	48	48	96	

Figure 3 Arria10 Family Device Comparison

2.3.1 Arria10 SoC/FPGA Power

The Arria10 SoC/FPGA SOM uses discrete power regulators along with DA9062 PMIC from Dialog Semiconductor for MPSoC power management. In Arria10 SoC/FPGA SOM, Core voltage & Periphery circuitry power supply of Arria10 HPS & FPGA (VCC, VCCP, VCCERAM & VCCL_HPS) is fixed to 0.95V. The HPS I/O voltage (VCCIO_HPS) is fixed to 1.8V. The I/O voltage details of each FPGA Bank & High speed transceiver is mentioned in the corresponding section.

The I/O voltage of Bank3B,3C & 3A which are connected to Board to Board Connectors are generated from PMIC LDO2, LDO3, LDO4 and by default set to 1.8V. I/O voltage is configurable through software after bootup.

2.3.2 Arria10 SoC/FPGA Reset

The Arria10 SoC/FPGA SOM uses PMIC's Reset output (nRESET) for HPS block POR for power on reset and the same POR is connected to FPGA Bank3A AN7 pin for FPGA fabric usage if needed. And this same signal is optionally connected to BANK2A AE17 through resistor and default not populated. By default, standard POR delay is supported in Arria10 SoC/FPGA SOM. Also it supports warm reset input from Board to Board Connector2 pin35 and connected to HPS_nRST pin of Arria10 SoC/FPGA.

2.3.3 Arria10 SoC/FPGA Reference Clocks

The Arria10 SoC/FPGA SOM supports on board clock oscillators for reference clock input to different blocks of Arria10 SoC/FPGA. These reference clock details are mentioned in the below table.

Table 3: Arria10 SoC/FPGA SOM Reference Clocks





SI No	On-SOM Oscillator Frequency	Arria10 Ball Name/ Pin Number	Signal Type/ Termination	Description
1	25MHz	HPS_CLK1/ B16	1.8V, LVCMOS	25Mhz single ended reference clock for HPS.
2	200MHz/ 267MHz/ 300MHz	CLK_2K_1p/E23 & CLK_2K_1n/E24	1.8V, LVDS	LVDS reference clock for HPS DDR4. <i>-3 Speed Grade for 200 Mhz.</i> <i>-2 Speed Grade for 267 Mhz.</i> <i>-1 Speed Grade for 300 Mhz.</i>
3	50MHz	CLK_2A_1p/ AM15	1.8V, LVCMOS	50Mhz single ended reference clock for FPGA. This is connected to Bank2A General Purpose Clock Input pin.
4	100MHz	CLKUSR/ AK16	1.8V, LVCMOS	100Mhz single ended reference clock for FPGA High Speed Transceiver. This is connected to Bank2A CLKUSR pin.
5	200MHz/ 267MHz/ 300MHz	CLK_3E_1p/F6 & CLK_3E_1n/F5	1.8V, LVDS	LVDS reference clock for FPGA DDR4. This is connected to Bank3E General Purpose Clock Input pin. <i>-3 Speed Grade for 200 Mhz.</i> <i>-2 Speed Grade for 267 Mhz.</i> <i>-1 Speed Grade for 300 Mhz.</i>

2.3.4 Arria10 SoC/FPGA Configuration Scheme

The Arria10 SoC/FPGA supports different configuration schemes JTAG-based configuration, AS Fast or Standard POR configuration and PS/FPP Fast or Standard POR configuration. These configuration schemes are selected using the MSEL pin setting.

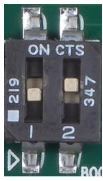
The Arria10 SoC/FPGA SOM supports FPGA Configuration Selection Switch (SW1) to set the required FPGA configuration scheme. This Configuration Selection Switch features are shown below.

Table 4: Configuration Selection Switch Truth Table

Arria10 SoC/FPGA Configuration Scheme	POR Delay	SW1 (2 Position Switch)		
		POS1 (MSEL0)	POS2 (MSEL1)	Image
AS (x1 and x4)	Fast	OFF	ON	
AS (x1 and x4)	Standard	ON	ON	
PS and FPP (x8, x16, and x32)	Fast	OFF	OFF	
PS and FPP (Configuration Via HPS) (Default)	Standard	ON	OFF	
JTAG-based configuration	-	-	-	Use any of the above valid MSEL pin settings
OFF – Low (0)		ON – High (1)		

Note: MSEL2 pin is fixed to 0 (Low) in the Arria10 SoC/FPGA SOM hardware.

2.3.5 Arria10 SoC/FPGA High Speed Transceivers

The Arria10 SoC/FPGA SOM supports 24 high speed transceivers on Board to Board connectors from Arria10 FPGA fabric. The Arria10 SoC/FPGA has four high speed transceiver banks (1C, 1D, 1E & 1F) and each transceiver bank has six high speed transmit and receive channels. Also, each high-speed transceiver bank supports two reference clock input pairs. Transceiver data rate performance is based on the transceiver speed grade of the Arria10 SoC/FPGA as mentioned in the below table.

Table 5: Arria10 SoC/FPGA Transceiver data rate performance

Description	Transceiver Speed Grade 1 (Gbps)	Transceiver Speed Grade 2 (Gbps)	Transceiver Speed Grade 3 (Gbps)	Transceiver Speed Grade 4 (Gbps)
Chip-to-Chip	17.4	15	14.2	12.5
Backplane	12.5	12.5	12.5	10.3125

The Arria10 SoC/FPGA SOM supports 16 high speed transceiver channels (6 from Bank1C, 6 from Bank1D & 4 from Bank1E) along with two reference clock input pairs of each bank (Bank1C, Bank1D & Bank1E) on Board to Board connector1 and 8 high speed transceiver channels (2 from Bank1E & 6 from Bank1F) along with two reference clock input pairs of Bank1F on Board to Board connector2. In Arria10 SoC/FPGA SOM, on board termination and AC coupling capacitor are not supported on transceiver lines. So it has to be taken care in the carrier board if required.

In Arria10 SoC/FPGA SOM, Transceiver power to Arria10 SoC/FPGA is fixed to 1.03V. Also it supports 100MHz Oscillator on board for transceiver reference clock and connected to Bank2A AK16 CLKUSR pin. This CLKUSR pin can be used for configuration and transceiver calibration simultaneously. For transceiver calibration, CLKUSR must be a free-running clock running between 100 MHz to 125 MHz at power-up for PS/FPP configuration scheme. Transceiver calibration starts utilizing the CLKUSR during device configuration and may continue to use it even when the device enters user mode.

2.4 PMIC

The Arria10 SoC/FPGA SOM supports Dialog semiconductor DA9062 PMIC. The I2C0 module of Arria10 SoC/FPGA SoC HPS is used for PMIC interface through I2C address 0x58.

PMIC's LDO2, LDO3, LDO4 output regulators are connected to I/O voltage of concern Banks (Bank 3B for LDO2, Bank3C for LDO3 & Bank3A for LDO4) and by default set to 1.8V. The I/O voltages are configurable through software after bootup.

2.5 Memory

2.5.1 DDR4 SDRAM with ECC for HPS/FPGA

The Arria10 SoC SOM supports 32bit, 2GB DDR4 SDRAM from HPS. Two 16bit, 1GB DDR4 SDRAM ICs are used to support a total on board RAM memory of 2GB for HPS. Also Arria10 SoC SOM supports 8bit ECC for RAM memory. In Arria10 SoC SOM, Bank2J & Bank2K is used for HPS DDR4 interface. DDR4 devices operates at 1.2V voltage level and so I/O voltage for Bank2J & Bank2K is fixed to 1.2V. The Arria10 SoC SOM supports LVDS Oscillator on board for HPS DDR4 reference clock. DDR4-SDRAM ICs are physically located on top side of the SOM. In Arria10 FPGA only SOM (where HPS is not available), DDR4 can still be used from FPGA fabric through Bank2J & Bank2K.

Note: The RAM size can be expandable in Arria10 SoC/FPGA SOM and contact iWave for more details.

2.5.2 DDR4 SDRAM for FPGA

The Arria10 SoC/FPGA SOM supports 64bit DDR4 SDRAM through FPGA fabric. Four 16bit DDR4 SDRAM ICs are used to support RAM memory. These DDR4-SDRAM ICs are physically located on top side of the SOM. The Arria10 SoC/FPGA SOM supports LVDS Oscillator on board for FPGA DDR4 reference clock and connected to Bank3E F5 & F6 dedicated clock input pins.

These DDR4 ICs are connected to FPGA Banks 3D, 3E & 3F of Arria10 SoC/FPGA and hence are only supported in higher device configurations of Arria10 SoC/FPGA devices (SX480/GX480, SX570/GX570, SX660/GX660, GX900, GX1150). The DDR4 SDRAM devices operates at 1.2V voltage level and so I/O voltage for Banks 3D, 3E & 3F is fixed to 1.2V.

2.5.3 MicroSD Connector for HPS booting

The Arria10 SoC has dedicated I/O pins for boot devices and other commonly-used peripherals from HPS. The Arria10 SoC SOM uses these dedicated I/O pins to connect MicroSD connector for default boot device. If Micro SD is not required as boot media, then same dedicated pins can be used to connect the eMMC Flash for boot.

MicroSD Card connector (J5) is connected to SD Controller of the Arria10 SoC through dedicated pins. It also supports card detect feature using HPS Dedicated IO "GPIO0_IO2". The main power to MicroSD Connector is 3.3V Voltage. A voltage Level translator is used to translate the SoC compatible 1.8V signals to 3.3V signals on MicroSD connector. Micro SD connector is physically located on topside of the SOM as shown below.

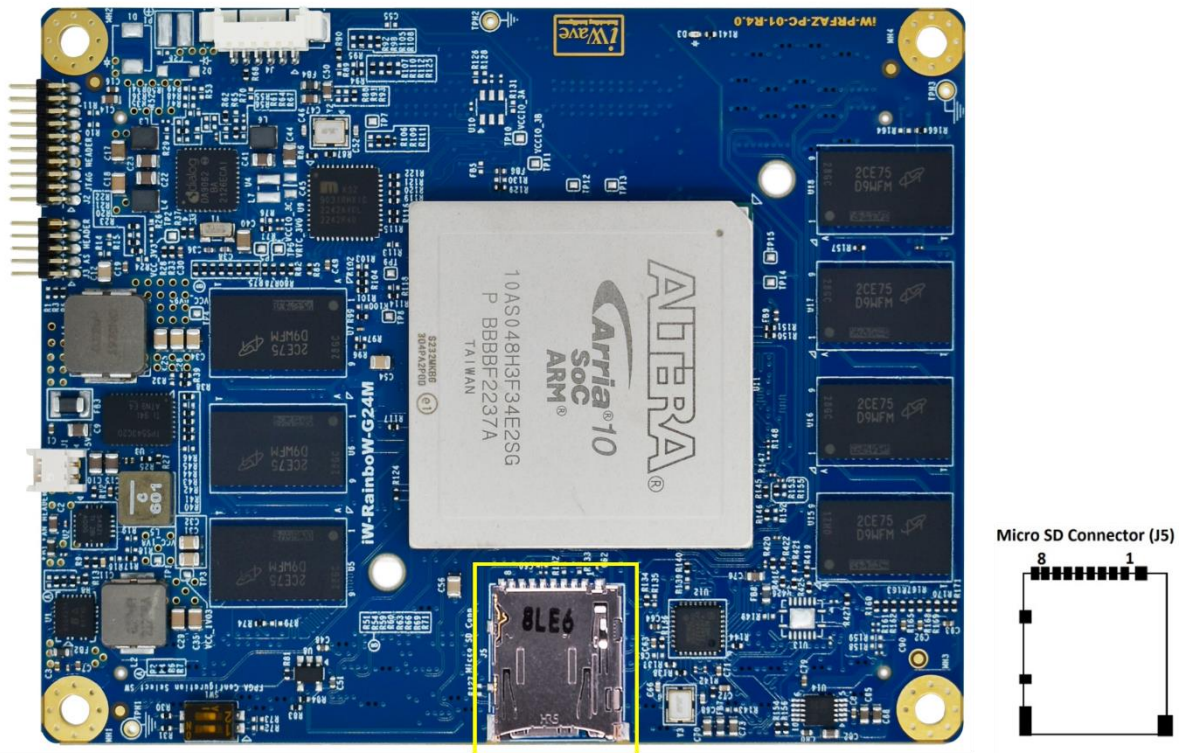

Figure 4: Micro SD Connector

2.5.4 eMMC Flash for HPS booting (Optional)

The Arria10 SoC SOM supports eMMC Flash as an optional boot device. This is connected to SD/MMC controller of the Arria10 SoC through dedicated pins and operates at 1.8V Voltage level. The eMMC Flash memory is physically located on the bottom side of the SOM. This is the optional feature and will not be populated in the default configuration.

2.5.5 Configuration Flash for FPGA

The Arria10 SoC/FPGA SOM supports Serial Flash for FPGA configuration. This configuration Flash is connected to Active Serial (AS) memory interface of the Arria10 SoC/FPGA and operating at 1.8V Voltage level. It supports AS x1 and AS x4 modes and can be programmed using the AS programming interface or JTAG interface.

Using the AS programming interface, the configuration data is programmed into the configuration Flash by the Quartus Prime software or any supported third-party software. Using the JTAG interface, an Altera IP called the SFL IP core must be downloaded into the Arria10 device to form a bridge between the JTAG interface and the configuration Flash which allows the configuration Flash to be programmed directly using the JTAG interface. The configuration Flash is physically located on bottom of the SOM.

2.6 On-SOM Features

2.6.1 JTAG Header

The Arria10 SoC/FPGA SOM supports a customized 20-pin ARM JTAG connector for JTAG debug interface. Arria10 SoC/FPGA's JTAG interface pins are 1.8V tolerant and so 1.8V reference power is provided to pin1 of the JTAG connector. This allows the JTAG tool to automatically configure the logic signals to the right voltage.

The Arria10 HPS and FPGA share a common set of JTAG pins and each have their own TAP controller which are chained together inside the Arria10 device. During power on-reset, the JTAG and all debug fuses are read by the Configuration subsystem to determine if the JTAG to the FPGA or HPS is bypassed. These JTAG interface signals are also connected to Board to Board Connector2 to access from carrier board. The JTAG connector (J2) is physically located on top side of the SOM as shown below.

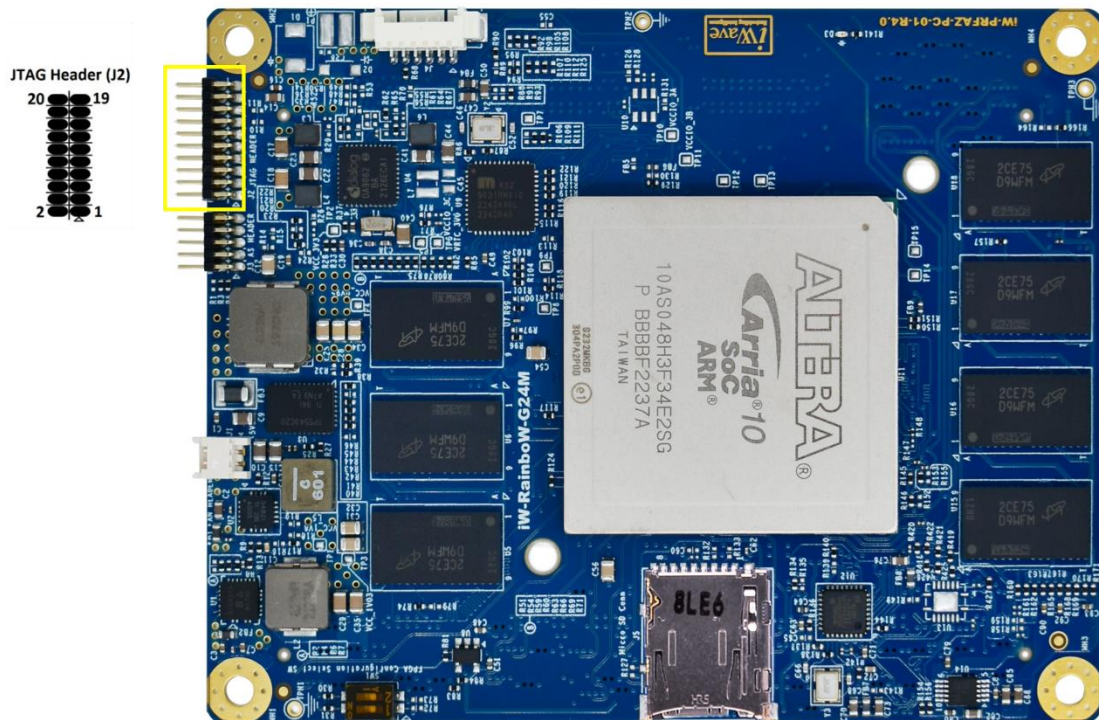

Figure 5: JTAG Header

Number of Pins	- 20
Connector Part	- GRPB102MWCN-RC from Sullins Connector Solutions
Mating Connector	- LPPB102CFFN-RC from Sullins Connector Solutions

Table 6: JTAG Header Pin Assignment

Pin No	Signal Name	Signal Type/ Termination	Description
1	VCC_1V8	O, 1.8V Power	VTREF Voltage Reference.
2	VCC_1V8	O, 1.8V Power	Supply Voltage.
3	CSS_TRST	I, 1.8V CMOS/ 10K PU	JTAG test reset signal.
4	GND	Power	Ground.
5	CSS_TDI	I, 1.8V CMOS/ 10K PU	JTAG test data input.
6	GND	Power	Ground.
7	CSS_TMS	I, 1.8V CMOS/ 10K PU	JTAG test mode select.
8	GND	Power	Ground.
9	CSS_TCK	I, 1.8V CMOS	JTAG test Clock.
10	GND	Power	Ground.
11	-	-	NC.
12	GND	Power	Ground.
13	CSS_TDO	O, 1.8V CMOS	JTAG test data output.
14	GND	Power	Ground.
15	-	-	NC.
16	GND	Power	Ground.
17	-	-	NC.
18	GND	Power	Ground.
19	-	-	NC.
20	GND	Power	Ground.

2.6.2 Fan Header

The Arria10 SoC/FPGA SOM supports a Fan Header to connect cooling Fan if required. Also in SOM there are mounting holes in either side of the Arria10 SoC/FPGA device which can be used to fix the Fan. This Fan Header (J1) is physically located at the top of the board as shown below.

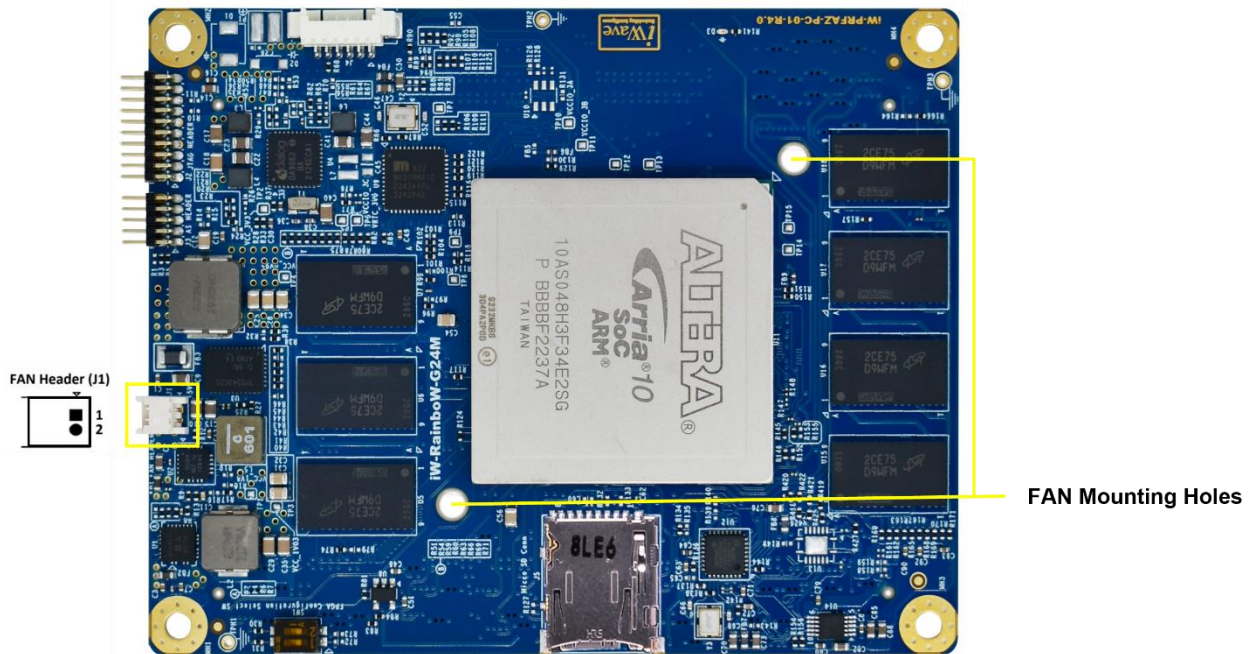

Figure 6: Fan Header

- Number of Pins - 2
- Connector Part - 0530480210 from Molex
- Mating Connector - 51021-0200 from Molex
- Compatible FAN (Example) - AFB0505MB from Delta Electronics

Table 7: FAN Header Pin Assignment

Pin No	Signal Name	Signal Type/ Termination	Description
1	VCC_5V	O, Power	+5V Power output to FAN.
2	GND	Power	Ground.

2.6.3 FPGA AS Header

The Arria10 SoC/FPGA SOM supports FPGA AS header for Active Serial Interface. This Active Serial Interface can be used to program the FPGA configuration Flash. Using this AS header, the external programmer serially transmits the operation commands and configuration bits to the configuration flash on Data0 using the download cable. During the verification, DATA1 transfers the programming data back to the download cable. Also the same AS interface signals are optionally connected to Board to Board connector2 44, 62, 64, 66, 68, 69, 71, 72. This FPGA AS Header (J3) is physically located at the top of the board as shown below.

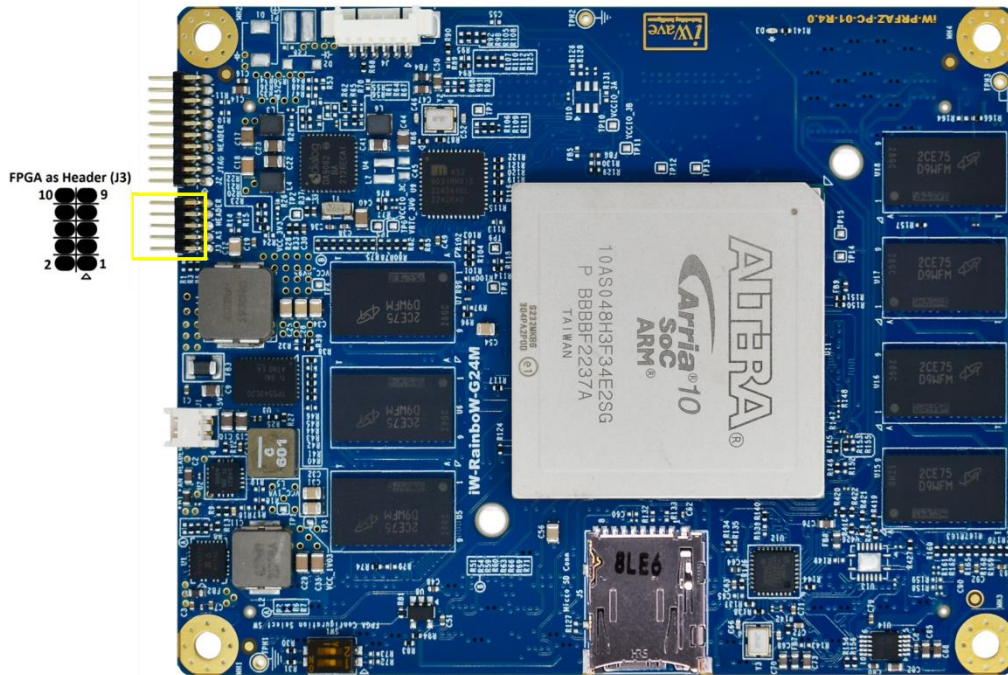

Figure 7: FPGA AS Header

- Number of Pins - 10
- Connector Part - GRPB052MWCN-RC from Sullins Connector Solutions
- Mating Connector - LPPB052CFFN-RC from Sullins Connector Solutions

Table 8: FPGA AS Header Pin Assignment

Pin No	Signal Name	Signal Type/ Termination	Description
1	CSS_DCLK	I, 1.8V CMOS/10K PD	Dedicated Serial clock to configure flash. <i>Note: This Same signal is optionally connected to 62nd pin of Board to Board connector2.</i>
2	GND	Power	Ground. <i>Note: AS_STATUS signal is optionally connected to this pin.</i>
3	AS_CONFIG_DONE	IO, 1.8V OD/10K PU	Configuration status IO to Arria10 SoC/FPGA. <i>Note: This Same signal is optionally connected to 64th pin of Board to Board connector2.</i>

Arria10 SoC/FPGA SOM Hardware User Guide

4	VCC_1V8	O,1.8V Power	Supply Voltage.
5	AS_CONFIG	I, 1.8V CMOS/10K PU	Configuration input to Arria10 SoC/FPGA. <i>Note: This Same signal is optionally connected to 66th pin of Board to Board connector2.</i>
6	CSS_nCE	I, 1.8V CMOS/10K PD	Chip Enable input to Arria10 SoC/FPGA. <i>Note: This Same signal is optionally connected to 44th pin of Board to Board connector2.</i>
7	CSS_AS_DATA0	I, 1.8V CMOS	Serial Data input to Configuration flash. <i>Note: This Same signal is optionally connected to 71st pin of Board to Board connector2.</i>
8	CSS_NCS00	I, 1.8V CMOS/10K PU	Chip select input to configuration flash. <i>Note: This Same signal is optionally connected to 69th pin of Board to Board connector2.</i>
9	CSS_AS_DATA1	O, 1.8V CMOS	Serial Data output from configuration flash. <i>Note: This Same signal is optionally connected to 72nd pin of Board to Board connector2.</i>
10	GND	Power	Ground.

Note: In iWave Arria10 SoC/FPGA SOM, DATA0 signal is connected to 7th pin & DATA1 Signal is connected to 9th pin of FPGA AS Header(J3).

2.7 Board to Board Connector1 Interfaces

The Arria10 SoC/FPGA SOM supports two 240pin High speed ground plane ruggedized terminal strip connectors for interfaces expansion. All the effort is made in Arria10 SoC/FPGA SOM design to provide the maximum interfaces of Arria10 SoC/FPGA to the carrier board by adding these two Board to Board connectors.

The interfaces which are available at Board to Board Connector1 are explained in following sections.

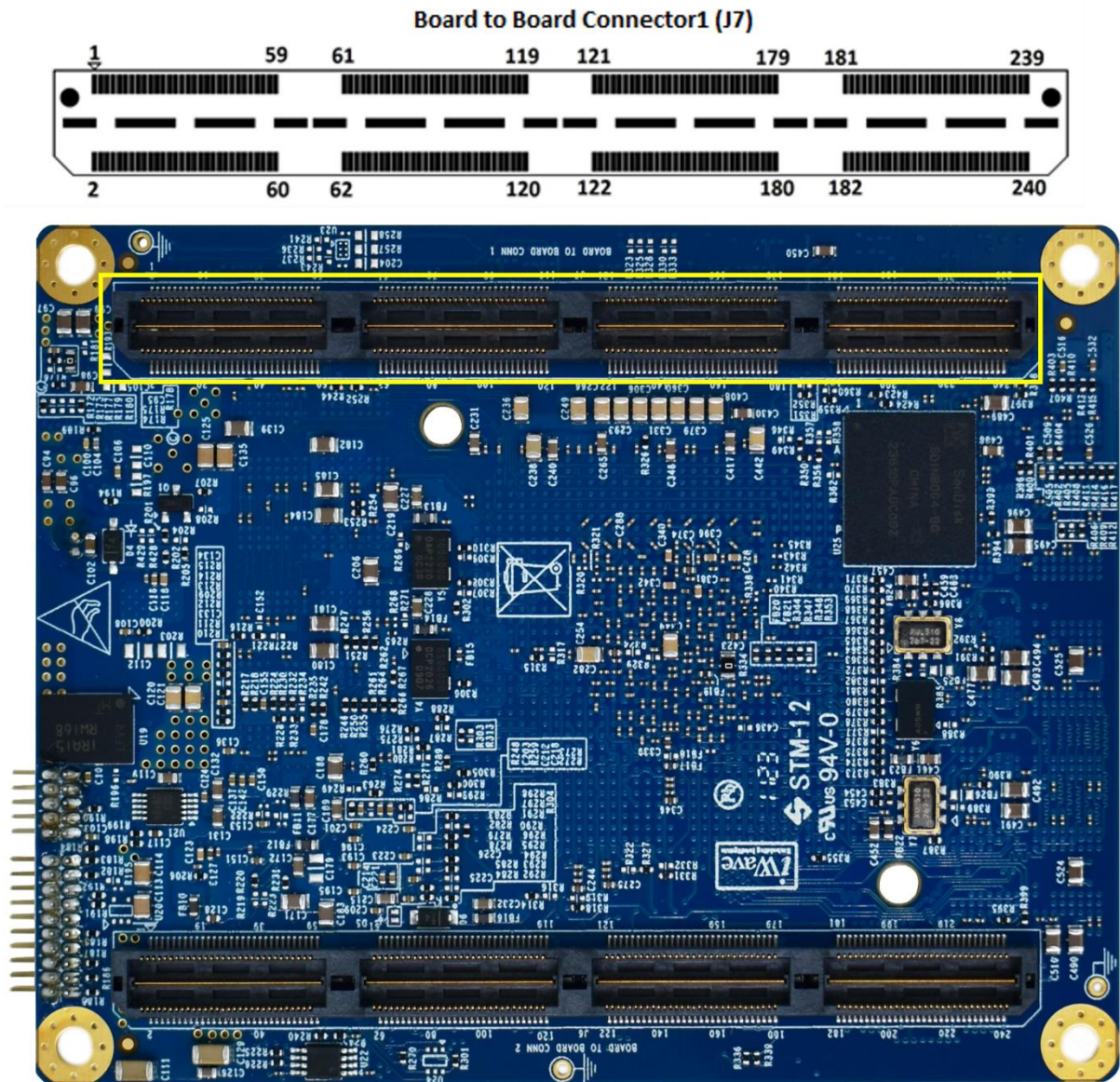

Figure 8: Board to Board Connector1

- Number of Pins - 240
- Connector Part Number- QTH-120-01-L-D-A
- Mating Connector - QSH-120-01-L-D-A from Samtech
- Staking Height - 5mm

Table 9 Board to Board Connector1 Pinout

Signal Name	B2B-1 Pin	B2B-1 Pin	Signal Name
GND	1	2	GND
GXBL1C_TX_CH0P	3	4	REFCLK_GXBL1C_CHTP
GXBL1C_TX_CH0N	5	6	REFCLK_GXBL1C_CHTN
GND	7	8	GND
GXBL1C_TX_CH1P	9	10	FPGA_AM7_LVDS3A_24N
GXBL1C_TX_CH1N	11	12	FPGA_AM1_LVDS3A_16P
GND	13	14	FPGA_AM2_LVDS3A_16N
GXBL1C_RX_CH1N	15	16	FPGA_AP4_LVDS3A_18P
GXBL1C_RX_CH1P	17	18	FPGA_AN4_LVDS3A_18N
GND	19	20	GND
GXBL1C_RX_CH0N	21	22	FPGA_AL3_LVDS3A_15N/CLKOUT_0N
GXBL1C_RX_CH0P	23	24	FPGA_AM3_LVDS3A_15P/CLKOUT_0P
GND	25	26	GND
FPGA_AM6_LVDS3A_17P	27	28	FPGA_AP6_LVDS3A_20N
FPGA_AM5_LVDS3A_17N	29	30	FPGA_AP7_LVDS3A_20P
FPGA_AP5_LVDS3A_19P	31	32	FPGA_AL6_LVDS3A_14P
FPGA_AN5_LVDS3A_19N	33	34	FPGA_AK6_LVDS3A_14N
GND	35	36	GND
GXBL1C_TX_CH2P	37	38	FPGA_AK7_LVDS3A_9P
GXBL1C_TX_CH2N	39	40	FPGA_AK8_LVDS3A_9N
GND	41	42	FPGA_AJ6_LVDS3A_11N
GXBL1C_TX_CH3P	43	44	FPGA_AJ7_LVDS3A_11P
GXBL1C_TX_CH3N	45	46	FPGA_AH7_LVDS3A_8P
GND	47	48	FPGA_AG7_LVDS3A_8N
GXBL1C_RX_CH3N	49	50	FPGA_AH8_LVDS3A_7P
GXBL1C_RX_CH3P	51	52	FPGA_AG8_LVDS3A_7N
GND	53	54	GND
GXBL1C_RX_CH2N	55	56	FPGA_AL4_LVDS3A_13N/CLKIN_0N
GXBL1C_RX_CH2P	57	58	FPGA_AL5_LVDS3A_13P/CLKIN_0P
GND	59	60	GND
GND	61	62	GND
GXBL1C_TX_CH4P	63	64	REFCLK_GXBL1C_CHBP
GXBL1C_TX_CH4N	65	66	REFCLK_GXBL1C_CHBN
GND	67	68	GND
GXBL1C_TX_CH5P	69	70	FPGA_AG10_LVDS3A_4P
GXBL1C_TX_CH5N	71	72	FPGA_AF10_LVDS3A_4N
GND	73	74	FPGA_AN8_LVDS3A_21P
GXBL1C_RX_CH5N	75	76	FPGA_AM8_LVDS3A_21N
GXBL1C_RX_CH5P	77	78	FPGA_AL9_LVDS3A_23P
GND	79	80	GND

Arria10 SoC/FPGA SOM Hardware User Guide

Signal Name	B2B-1 Pin	B2B-1 Pin	Signal Name
GXBL1C_RX_CH4N	81	82	FPGA_AK9_LVDS3A_12N/CLKIN_1N
GXBL1C_RX_CH4P	83	84	FPGA_AJ9_LVDS3A_12P/CLKIN_1P
GND	85	86	GND
FPGA_AF9_LVDS3A_1P	87	88	FPGA_AN9_LVDS3A_22N
FPGA_AE9_LVDS3A_1N	89	90	FPGA_AP9_LVDS3A_22P
FPGA_AF8_LVDS3A_2P	91	92	FPGA_AH10_LVDS3A_3P
FPGA_AE8_LVDS3A_2N	93	94	FPGA_AH9_LVDS3A_3N
GND	95	96	GND
GXBL1D_TX_CH0P	97	98	REFCLK_GXBL1D_CHTP
GXBL1D_TX_CH0N	99	100	REFCLK_GXBL1D_CHTN
GND	101	102	GND
GXBL1D_TX_CH1P	103	104	FPGA_AL8_LVDS3A_23N
GXBL1D_TX_CH1N	105	106	FPGA_AG11_LVDS3A_5N
GND	107	108	FPGA_AF11_LVDS3A_5P
GXBL1D_RX_CH1N	109	110	FPGA_AE11_LVDS3A_6N
GXBL1D_RX_CH1P	111	112	FPGA_AE12_LVDS3A_6P
GND	113	114	GND
GXBL1D_RX_CH0N	115	116	FPGA_AH5_LVDS3A_10N/CLKOUT_1N
GXBL1D_RX_CH0P	117	118	FPGA_AJ5_LVDS3A_10P/CLKOUT_1P
GND	119	120	GND
GND	121	122	GND
GXBL1D_TX_CH2P	123	124	FPGA_AG17_LVDS2A_15P/CLKOUT_0P
GXBL1D_TX_CH2N	125	126	FPGA_AH17_LVDS2A_15N/CLKOUT_0N
GND	127	128	FPGA_AD19_LVDS2A_21P
GXBL1D_TX_CH3P	129	130	FPGA_AH18_LVDS2A_13P/CLKIN_0P
GXBL1D_TX_CH3N	131	132	FPGA_AH19_LVDS2A_13N/CLKIN_0N
GND	133	134	FPGA_AE18_LVDS2A_21N
GXBL1D_RX_CH3N	135	136	FPGA_AJ17_LVDS2A_16P
GXBL1D_RX_CH3P	137	138	FPGA_AK17_LVDS2A_16N
GND	139	140	GND
GXBL1D_RX_CH2N	141	142	FPGA_AM16_LVDS2A_10N/CLKOUT_0N
GXBL1D_RX_CH2P	143	144	FPGA_AL16_LVDS2A_10P/CLKOUT_0P
GND	145	146	GND
FPGA_AP16_LVDS2A_2P	147	148	FPGA_AP12_LVDS2A_5N
FPGA_AP17_LVDS2A_2N	149	150	FPGA_AN12_LVDS2A_5P
FPGA_AL18_LVDS2A_11N	151	152	FPGA_AH15_LVDS2A_17N
FPGA_AK18_LVDS2A_11P	153	154	FPGA_AJ15_LVDS2A_17P
GND	155	156	GND
GXBL1D_TX_CH4P	157	158	REFCLK_GXBL1D_CHBP
GXBL1D_TX_CH4N	159	160	REFCLK_GXBL1D_CHBN
GND	161	162	GND

Arria10 SoC/FPGA SOM Hardware User Guide

Signal Name	B2B-1 Pin	B2B-1 Pin	Signal Name
GXBL1D_TX_CH5P	163	164	FPGA_AG16_LVDS2A_20P
GXBL1D_TX_CH5N	165	166	FPGA_AF16_LVDS2A_20N
GND	167	168	FPGA_AE17_LVDS2A_19n
GXBL1D_RX_CH5N	169	170	FPGA_AE16_LVDS2A_19P
GXBL1D_RX_CH5P	171	172	FPGA_AC17_LVDS2A_24P
GND	173	174	GND
GXBL1D_RX_CH4N	175	176	FPGA_AH14_LVDS2A_14N
GXBL1D_RX_CH4P	177	178	FPGA_AJ14_LVDS2A_14P
GND	179	180	GND
GND	181	182	GND
GXBL1E_TX_CH0P	183	184	REFCLK_GXBL1E_CHTP
GXBL1E_TX_CH0N	185	186	REFCLK_GXBL1E_CHTN
GND	187	188	GND
GXBL1E_TX_CH1P	189	190	FPGA_AD17_LVDS2A_24N
GXBL1E_TX_CH1N	191	192	FPGA_AE19_LVDS2A_22N
GND	193	194	FPGA_AF19_LVDS2A_22P
GXBL1E_RX_CH1N	195	196	FPGA_AF18_LVDS2A_23P
GXBL1E_RX_CH1P	197	198	FPGA_AG18_LVDS2A_23N
GND	199	200	GND
GXBL1E_RX_CH0N	201	202	FPGA_AN17_LVDS2A_8N
GXBL1E_RX_CH0P	203	204	FPGA_AM17_LVDS2A_8P
GND	205	206	GND
FPGA_AP15_LVDS2A_3N	207	208	FPGA_AP14_LVDS2A_6N
FPGA_AN15_LVDS2A_3P	209	210	FPGA_AN14_LVDS2A_6P
FPGA_AM18_LVDS2A_7P	211	212	FPGA_AL14_LVDS2A_9P
FPGA_AN18_LVDS2A_7N	213	214	FPGA_AK14_LVDS2A_9N
GND	215	216	GND
GXBL1E_TX_CH2P	217	218	REFCLK_GXBL1E_CHBP
GXBL1E_TX_CH2N	219	220	REFCLK_GXBL1E_CHBN
GND	221	222	GND
GXBL1E_TX_CH3P	223	224	FPGA_AL15_LVDS2A_12N
GXBL1E_TX_CH3N	225	226	FPGA_AK13_LVDS2A_1N
GND	227	228	FPGA_AL13_LVDS2A_1P
GXBL1E_RX_CH3N	229	230	FPGA_AJ16_LVDS2A_18P
GXBL1E_RX_CH3P	231	232	SOMPWR_EN
GND	233	234	GND
GXBL1E_RX_CH2N	235	236	FPGA_AM13_LVDS2A_4N
GXBL1E_RX_CH2P	237	238	FPGA_AN13_LVDS2A_4P
GND	239	240	GND

2.7.1 FPGA High Speed Transceivers

The Arria10 SoC/FPGA SOM supports 16 high speed transceiver channels (6 from 1C bank, 6 from 1D bank & 4 from 1E bank) on Board to Board connector1. In Arria10 SoC/FPGA SOM, Transceiver power to Arria10 SoC/FPGA is fixed to 1.03V. Also it supports 100MHz Oscillator on board for transceiver reference clock and connected to Bank2A AK16 CLKUSR pin.

For more details on High Speed transceiver pinouts on Board to Board Connector1, refer the below table.

B2B-1 Pin No	B2B Connector1 Pin Name	SoC Ball Name/ Pin Number	Signal Type/ Termination	Description
BANK-1C Channels				
3	GXBL1C_TX_CH0p	GXBL1C_TX_CH0P/ AP32	O, DIFF	Bank1C channel0 High speed differential transmitter positive.
5	GXBL1C_TX_CH0n	GXBL1C_TX_CH0N/ AP31	O, DIFF	Bank1C channel0 High speed differential transmitter Negative.
23	GXBL1C_RX_CH0p	GXBL1C_RX_CH0P/ AL30	I, DIFF	Bank1C channel0 High speed differential receiver positive.
21	GXBL1C_RX_CH0n	GXBL1C_RX_CH0N/ AL29	I, DIFF	Bank1C channel0 High speed differential receiver Negative.
9	GXBL1C_TX_CH1p	GXBL1C_TX_CH1P/ AM32	O, DIFF	Bank1C channel1 High speed differential transmitter positive.
11	GXBL1C_TX_CH1n	GXBL1C_TX_CH1N/ AM31	O, DIFF	Bank1C channel1 High speed differential transmitter Negative.
17	GXBL1C_RX_CH1p	GXBL1C_RX_CH1P/ AJ30	I, DIFF	Bank1C channel1 High speed differential receiver positive.
15	GXBL1C_RX_CH1n	GXBL1C_RX_CH1N/ AJ29	I, DIFF	Bank1C channel1 High speed differential receiver Negative.
37	GXBL1C_TX_CH2p	GXBL1C_TX_CH2P/ AK32	O, DIFF	Bank1C channel2 High speed differential transmitter positive.
39	GXBL1C_TX_CH2n	GXBL1C_TX_CH2N/ AK31	O, DIFF	Bank1C channel2 High speed differential transmitter Negative.
57	GXBL1C_RX_CH2p	GXBL1C_RX_CH2P/ AG30	I, DIFF	Bank1C channel2 High speed differential receiver positive.
55	GXBL1C_RX_CH2n	GXBL1C_RX_CH2N/ AG29	I, DIFF	Bank1C channel2 High speed differential receiver Negative.
43	GXBL1C_TX_CH3p	GXBL1C_TX_CH3P/ AH32	O, DIFF	Bank1C channel3 High speed differential transmitter positive.
45	GXBL1C_TX_CH3n	GXBL1C_TX_CH3N/ AH31	O, DIFF	Bank1C channel3 High speed differential transmitter Negative.
51	GXBL1C_RX_CH3p	GXBL1C_RX_CH3P/ AF32	I, DIFF	Bank1C channel3 High speed differential receiver positive.
49	GXBL1C_RX_CH3n	GXBL1C_RX_CH3N/ AF31	I, DIFF	Bank1C channel3 High speed differential receiver Negative.

Arria10 SoC/FPGA SOM Hardware User Guide

B2B-1 Pin No	B2B Connector1 Pin Name	SoC Ball Name/ Pin Number	Signal Type/ Termination	Description
63	GXBL1C_TX_CH4p	GXBL1C_TX_CH4P/ AN34	O, DIFF	Bank1C channel4 High speed differential transmitter positive.
65	GXBL1C_TX_CH4n	GXBL1C_TX_CH4N/ AN33	O, DIFF	Bank1C channel4 High speed differential transmitter Negative.
83	GXBL1C_RX_CH4p	GXBL1C_RX_CH4P/ AE30	I, DIFF	Bank1C channel4 High speed differential receiver positive.
81	GXBL1C_RX_CH4n	GXBL1C_RX_CH4N/ AE29	I, DIFF	Bank1C channel4 High speed differential receiver Negative.
69	GXBL1C_TX_CH5p	GXBL1C_TX_CH5P/ AL34	O, DIFF	Bank1C channel5 High speed differential transmitter positive.
71	GXBL1C_TX_CH5n	GXBL1C_TX_CH5N/ AL33	O, DIFF	Bank1C channel5 High speed differential transmitter Negative.
77	GXBL1C_RX_CH5p	GXBL1C_RX_CH5P/ AD32	I, DIFF	Bank1C channel5 High speed differential receiver positive.
75	GXBL1C_RX_CH5n	GXBL1C_RX_CH5N/ AD31	I, DIFF	Bank1C channel5 High speed differential receiver Negative.
64	REFCLK_GXBL1C_CHBp	REFCLK_GXBL1C_CHBP/ AF28	I, DIFF	Bank1C differential Bottom reference clock positive.
66	REFCLK_GXBL1C_CHBn	REFCLK_GXBL1C_CHBN/ AF27	I, DIFF	Bank1C differential Bottom reference clock Negative.
4	REFCLK_GXBL1C_CHTp	REFCLK_GXBL1C_CHTP/ AD28	I, DIFF	Bank1C differential Top reference clock positive.
6	REFCLK_GXBL1C_CHTn	REFCLK_GXBL1C_CHTN/ AD27	I, DIFF	Bank1C differential Top reference clock Negative.
BANK-1D Channels				
97	GXBL1D_TX_CH0P	GXBL1D_TX_CH0p/ AJ34	O, DIFF	Bank1D channel0 High speed differential transmitter positive.
99	GXBL1D_TX_CH0N	GXBL1D_TX_CH0n/ AJ33	O, DIFF	Bank1D channel0 High speed differential transmitter Negative.
117	GXBL1D_RX_CH0P	GXBL1D_RX_CH0p/ AC30	I, DIFF	Bank1D channel0 High speed differential receiver positive.
115	GXBL1D_RX_CH0N	GXBL1D_RX_CH0n/ AC29	I, DIFF	Bank1D channel0 High speed differential receiver Negative.
103	GXBL1D_TX_CH1P	GXBL1D_TX_CH1p/ AG34	O, DIFF	Bank1D channel1 High speed differential transmitter positive.
105	GXBL1D_TX_CH1N	GXBL1D_TX_CH1n/ AG33	O, DIFF	Bank1D channel1 High speed differential transmitter Negative.
111	GXBL1D_RX_CH1P	GXBL1D_RX_CH1p/ AB32	I, DIFF	Bank1D channel1 High speed differential receiver positive.
109	GXBL1D_RX_CH1N	GXBL1D_RX_CH1n/ AB31	I, DIFF	Bank1D channel1 High speed differential receiver Negative.

Arria10 SoC/FPGA SOM Hardware User Guide

B2B-1 Pin No	B2B Connector1 Pin Name	SoC Ball Name/ Pin Number	Signal Type/ Termination	Description
123	GXBL1D_TX_CH2P	GXBL1D_TX_CH2p/ AE34	O, DIFF	Bank1D channel2 High speed differential transmitter positive.
125	GXBL1D_TX_CH2N	GXBL1D_TX_CH2n/ AE33	O, DIFF	Bank1D channel2 High speed differential transmitter Negative.
143	GXBL1D_RX_CH2P	GXBL1D_RX_CH2p/ AA30	I, DIFF	Bank1D channel2 High speed differential receiver positive.
141	GXBL1D_RX_CH2N	GXBL1D_RX_CH2n/ AA29	I, DIFF	Bank1D channel2 High speed differential receiver Negative.
129	GXBL1D_TX_CH3P	GXBL1D_TX_CH3p/ AC34	O, DIFF	Bank1D channel3 High speed differential transmitter positive.
131	GXBL1D_TX_CH3N	GXBL1D_TX_CH3n/ AC33	O, DIFF	Bank1D channel3 High speed differential transmitter Negative.
137	GXBL1D_RX_CH3P	GXBL1D_RX_CH3p/ Y32	I, DIFF	Bank1D channel3 High speed differential receiver positive.
135	GXBL1D_RX_CH3N	GXBL1D_RX_CH3n/ Y31	I, DIFF	Bank1D channel3 High speed differential receiver Negative.
157	GXBL1D_TX_CH4P	GXBL1D_TX_CH4p/ AA34	O, DIFF	Bank1D channel4 High speed differential transmitter positive.
159	GXBL1D_TX_CH4N	GXBL1D_TX_CH4n/ AA33	O, DIFF	Bank1D channel4 High speed differential transmitter Negative.
177	GXBL1D_RX_CH4P	GXBL1D_RX_CH4p/ W30	I, DIFF	Bank1D channel4 High speed differential receiver positive.
175	GXBL1D_RX_CH4N	GXBL1D_RX_CH4n/ W29	I, DIFF	Bank1D channel4 High speed differential receiver Negative.
163	GXBL1D_TX_CH5P	GXBL1D_TX_CH5p/ W34	O, DIFF	Bank1D channel5 High speed differential transmitter positive.
165	GXBL1D_TX_CH5N	GXBL1D_TX_CH5n/ W33	O, DIFF	Bank1D channel5 High speed differential transmitter Negative.
171	GXBL1D_RX_CH5P	GXBL1D_RX_CH5p/ V32	I, DIFF	Bank1D channel5 High speed differential receiver positive.
169	GXBL1D_RX_CH5N	GXBL1D_RX_CH5n/ V31	I, DIFF	Bank1D channel5 High speed differential receiver Negative.
158	REFCLK_GXBL1D_CHBP	REFCLK_GXBL1D_CHBp/ AB28	I, DIFF	Bank1D differential Bottom reference clock positive.
160	REFCLK_GXBL1D_CHBN	REFCLK_GXBL1D_CHBn/ AB27	I, DIFF	Bank1D differential Bottom reference clock Negative.
98	REFCLK_GXBL1D_CHTP	REFCLK_GXBL1D_CHTp/ Y28	I, DIFF	Bank1D differential Top reference clock positive.
100	REFCLK_GXBL1D_CHTN	REFCLK_GXBL1D_CHTn/ Y27	I, DIFF	Bank1D differential Top reference clock Negative.
BANK-1E Channels				

Arria10 SoC/FPGA SOM Hardware User Guide

B2B-1 Pin No	B2B Connector1 Pin Name	SoC Ball Name/ Pin Number	Signal Type/ Termination	Description
183	GXBL1E_TX_CH0P	GXBL1E_TX_CH0p/ U34	O, DIFF	Bank1E channel0 High speed differential transmitter positive.
185	GXBL1E_TX_CH0N	GXBL1E_TX_CH0n/ U33	O, DIFF	Bank1E channel0 High speed differential transmitter Negative.
203	GXBL1E_RX_CH0P	GXBL1E_RX_CH0p/ U30	I, DIFF	Bank1E channel0 High speed differential receiver positive.
201	GXBL1E_RX_CH0N	GXBL1E_RX_CH0n/ U29	I, DIFF	Bank1E channel0 High speed differential receiver Negative.
189	GXBL1E_TX_CH1P	GXBL1E_TX_CH1p/ R34	O, DIFF	Bank1E channel1 High speed differential transmitter positive.
191	GXBL1E_TX_CH1N	GXBL1E_TX_CH1n/ R33	O, DIFF	Bank1E channel1 High speed differential transmitter Negative.
197	GXBL1E_RX_CH1P	GXBL1E_RX_CH1p/ T32	I, DIFF	Bank1E channel1 High speed differential receiver positive.
195	GXBL1E_RX_CH1N	GXBL1E_RX_CH1n/ T31	I, DIFF	Bank1E channel1 High speed differential receiver Negative.
217	GXBL1E_TX_CH2P	GXBL1E_TX_CH2p/ N34	O, DIFF	Bank1E channel2 High speed differential transmitter positive.
219	GXBL1E_TX_CH2N	GXBL1E_TX_CH2n/ N33	O, DIFF	Bank1E channel2 High speed differential transmitter Negative.
237	GXBL1E_RX_CH2P	GXBL1E_RX_CH2p/ R30	I, DIFF	Bank1E channel2 High speed differential receiver positive.
235	GXBL1E_RX_CH2N	GXBL1E_RX_CH2n/ R29	I, DIFF	Bank1E channel2 High speed differential receiver Negative.
223	GXBL1E_TX_CH3P	GXBL1E_TX_CH3p/ L34	O, DIFF	Bank1E channel3 High speed differential transmitter positive.
225	GXBL1E_TX_CH3N	GXBL1E_TX_CH3n/ L33	O, DIFF	Bank1E channel3 High speed differential transmitter Negative.
231	GXBL1E_RX_CH3P	GXBL1E_RX_CH3p/ P32	I, DIFF	Bank1E channel3 High speed differential receiver positive.
229	GXBL1E_RX_CH3N	GXBL1E_RX_CH3n/ P31	I, DIFF	Bank1E channel3 High speed differential receiver Negative.
184	REFCLK_GXBL1E_CHTP	REFCLK_GXBL1E_CHTp/ T28	I, DIFF	Bank1E differential Top reference clock positive.
186	REFCLK_GXBL1E_CHTN	REFCLK_GXBL1E_CHTn/ T27	I, DIFF	Bank1E differential Top reference clock Negative.
218	REFCLK_GXBL1E_CHBP	REFCLK_GXBL1E_CHBp/ V28	I, DIFF	Bank1E differential Bottom reference clock positive.
220	REFCLK_GXBL1E_CHBN	REFCLK_GXBL1E_CHBn/ V27	I, DIFF	Bank1E differential Bottom reference clock Negative.

2.7.2 FPGA IOs & General Purpose Clocks – Bank2A

The Arria10 SoC/FPGA SOM supports upto 21 LVDS IOs/46 Single Ended IOs and from Arria10 FPGA Bank2A on Board to Board connector1. In Arria10 SoC/FPGA SOM, Bank2A signals are routed as LVDS IOs to Board to Board Connector1. Even though Bank2A signals are routed as LVDS IOs, these pins can be used as SE IOs if required. Every LVDS pair can be configured as receiver or transmitter and works upto 1.6 Gbps.

In Arria10 SoC/FPGA SOM, upon these 21 LVDS IOs/46 Single Ended IOs from Arria10 FPGA Bank2A, one General Purpose Clock input LVDS pair and two General Purpose Clock Output LVDS pairs are supported on Board to Board connector1. If Single Ended Clock is required instead of LVDS, then the same LVDS clock pins can be configured as General Purpose single ended clock. In Arria10 SoC/FPGA SOM, Bank2A I/O voltage is fixed to 1.8V.

For more details on FPGA Bank2A pinouts on Board to Board Connector1, refer the below table.

B2B-1 Pin No	B2B Connector1 Pin Name	SoC Ball Name/ Pin Number	Signal Type/ Termination	Description
124	FPGA_AG17_LVDS2A_15P/CLKOUT_0P	LVDS2A_15p/AG17	IO, 1.8V LVDS	Bank2A IO15 differential Positive. Same pin can be configured as Clock0 Output differential Positive or Single ended I/O.
126	FPGA_AH17_LVDS2A_15N/CLKOUT_0N	LVDS2A_15n/AH17	IO, 1.8V LVDS	Bank2A IO15 differential Negative. Same pin can be configured as Clock0 Output differential Negative or Single ended I/O.
128	FPGA_AD19_LVDS2A_21P	LVDS2A_21p/AD19	IO, 1.8V LVCMOS	Bank2A IO21 Single Ended I/O.
130	FPGA_AH18_LVDS2A_13P/CLKIN_0P	LVDS2A_13p/AH18	IO, 1.8V LVDS	Bank2A IO13 differential Positive. Same pin can be configured as Clock0 Input differential Positive or Single ended I/O.
132	FPGA_AH19_LVDS2A_13N/CLKIN_0N	LVDS2A_13n/AH19	IO, 1.8V LVDS	Bank2A IO13 differential Negative. Same pin can be configured as Clock0 Input differential Negative or Single ended I/O.
134	FPGA_AE18_LVDS2A_21N	LVDS2A_21n/AE18	IO, 1.8V LVCMOS	Bank2A IO21 Single Ended I/O.
136	FPGA_AJ17_LVDS2A_16P	LVDS2A_16p/AJ17	IO, 1.8V LVDS	Bank2A IO16 differential Positive. Same pin can be configured Single ended I/O.
138	FPGA_AK17_LVDS2A_16N	LVDS2A_16n/AK17	IO, 1.8V LVDS	Bank2A IO16 differential Negative. Same pin can be configured Single ended I/O.

Arria10 SoC/FPGA SOM Hardware User Guide

B2B-1 Pin No	B2B Connector1 Pin Name	SoC Ball Name/ Pin Number	Signal Type/ Termination	Description
142	FPGA_AM16_LVDS2A_10N/CLKOUT_0N	LVDS2A_10n/AM16	IO, 1.8V LVDS	Bank2A IO10 differential Negative. Same pin can be configured as Clock0 Output differential Negative or Single ended I/O.
144	FPGA_AL16_LVDS2A_10P/CLKOUT_0P	LVDS2A_10p/AL16	IO, 1.8V LVDS	Bank2A IO10 differential Positive. Same pin can be configured as Clock0 Output differential Positive or Single ended I/O.
147	FPGA_AP16_LVDS2A_2P	LVDS2A_2p/AP16	IO, 1.8V LVDS	Bank2A IO2 differential Positive. Same pin can be configured Single ended I/O.
148	FPGA_AP12_LVDS2A_5N	LVDS2A_5n/AP12	IO, 1.8V LVDS	Bank2A IO5 differential Negative. Same pin can be configured Single ended I/O.
149	FPGA_AP17_LVDS2A_2N	LVDS2A_2n/AP17	IO, 1.8V LVDS	Bank2A IO2 differential Negative. Same pin can be configured Single ended I/O.
150	FPGA_AN12_LVDS2A_5P	LVDS2A_5p/AN12	IO, 1.8V LVDS	Bank2A IO5 differential Positive. Same pin can be configured Single ended I/O.
151	FPGA_AL18_LVDS2A_11N	LVDS2A_11n/AL18	IO, 1.8V LVDS	Bank2A IO11 differential Negative. Same pin can be configured Single ended I/O.
152	FPGA_AH15_LVDS2A_17N	LVDS2A_17n/AH15	IO, 1.8V LVDS	Bank2A IO17 differential Negative. Same pin can be configured Single ended I/O.
153	FPGA_AK18_LVDS2A_11P	LVDS2A_11p/AK18	IO, 1.8V LVDS	Bank2A IO11 differential Positive. Same pin can be configured Single ended I/O.
154	FPGA_AJ15_LVDS2A_17P	LVDS2A_17p/AJ15	IO, 1.8V LVDS	Bank2A IO17 differential Positive. Same pin can be configured Single ended I/O.
164	FPGA_AG16_LVDS2A_20P	LVDS2A_20p/AG16	IO, 1.8V LVDS	Bank2A IO20 differential Positive. Same pin can be configured Single ended I/O.
166	FPGA_AF16_LVDS2A_20N	LVDS2A_20n/AF16	IO, 1.8V LVDS	Bank2A IO20 differential Negative. Same pin can be configured Single ended I/O.
170	FPGA_AE16_LVDS2A_19P	LVDS2A_19p/AE16	IO, 1.8V LVDS/10KPU	Bank2A IO19 differential Positive. Same pin can be configured Single ended I/O.
172	FPGA_AC17_LVDS2A_24P	LVDS2A_24p/AC17	IO, 1.8V LVDS	Bank2A IO24 differential Positive. Same pin can be configured Single ended I/O.

Arria10 SoC/FPGA SOM Hardware User Guide

B2B-1 Pin No	B2B Connector1 Pin Name	SoC Ball Name/ Pin Number	Signal Type/ Termination	Description
176	FPGA_AH14_LVDS2A_14N	LVDS2A_14n/AH14	IO, 1.8V LVDS	Bank2A IO14 differential Negative. Same pin can be configured Single ended I/O.
178	FPGA_AJ14_LVDS2A_14P	LVDS2A_14p/AJ14	IO, 1.8V LVDS	Bank2A IO14 differential Positive. Same pin can be configured Single ended I/O.
190	FPGA_AD17_LVDS2A_24N	LVDS2A_24n/AD17	IO, 1.8V LVDS	Bank2A IO24 differential Negative. Same pin can be configured Single ended I/O.
192	FPGA_AE19_LVDS2A_22N	LVDS2A_22n/AE19	IO, 1.8V LVDS	Bank2A IO22 differential Negative. Same pin can be configured Single ended I/O.
194	FPGA_AF19_LVDS2A_22P	LVDS2A_22p/AF19	IO, 1.8V LVDS	Bank2A IO22 differential Positive. Same pin can be configured Single ended I/O.
196	FPGA_AF18_LVDS2A_23P	LVDS2A_23p/AF18	IO, 1.8V LVDS	Bank2A IO23 differential Positive. Same pin can be configured Single ended I/O.
198	FPGA_AG18_LVDS2A_23N	LVDS2A_23n/AG18	IO, 1.8V LVDS	Bank2A IO23 differential Negative. Same pin can be configured Single ended I/O.
202	FPGA_AN17_LVDS2A_8N	LVDS2A_8n/AN17	IO, 1.8V LVDS	Bank2A IO8 differential Negative. Same pin can be configured Single ended I/O.
204	FPGA_AM17_LVDS2A_8P	LVDS2A_8p/AM17	IO, 1.8V LVDS	Bank2A IO8 differential Positive. Same pin can be configured Single ended I/O.
207	FPGA_AP15_LVDS2A_3N	LVDS2A_3n/AP15	IO, 1.8V LVDS	Bank2A IO3 differential Negative. Same pin can be configured Single ended I/O.
208	FPGA_AP14_LVDS2A_6N	LVDS2A_6n/AP14	IO, 1.8V LVDS	Bank2A IO6 differential Negative. Same pin can be configured Single ended I/O.
209	FPGA_AN15_LVDS2A_3P	LVDS2A_3p/AN15	IO, 1.8V LVDS	Bank2A IO3 differential Positive. Same pin can be configured Single ended I/O.
210	FPGA_AN14_LVDS2A_6P	LVDS2A_6p/AN14	IO, 1.8V LVDS	Bank2A IO6 differential Positive. Same pin can be configured Single ended I/O.
211	FPGA_AM18_LVDS2A_7P	LVDS2A_7p/AM18	IO, 1.8V LVDS	Bank2A IO7 differential Positive. Same pin can be configured Single ended I/O.

B2B-1 Pin No	B2B Connector1 Pin Name	SoC Ball Name/ Pin Number	Signal Type/ Termination	Description
212	FPGA_AL14_LVDS2A_9P	LVDS2A_9p/AL14	IO, 1.8V LVDS	Bank2A IO9 differential Positive. Same pin can be configured Single ended I/O.
213	FPGA_AN18_LVDS2A_7N	LVDS2A_7n/AN18	IO, 1.8V LVDS	Bank2A IO7 differential Negative. Same pin can be configured Single ended I/O.
214	FPGA_AK14_LVDS2A_9N	LVDS2A_9n/AK14	IO, 1.8V LVDS	Bank2A IO9 differential Negative. Same pin can be configured Single ended I/O.
224	FPGA_AL15_LVDS2A_12N	LVDS2A_12n/AL15	IO, 1.8V LVCMOS	Bank2A IO12 Single Ended I/O.
226	FPGA_AK13_LVDS2A_1N	LVDS2A_1n/AK13	IO, 1.8V LVDS	Bank2A IO1 differential Negative. Same pin can be configured Single ended I/O.
228	FPGA_AL13_LVDS2A_1P	LVDS2A_1p/AL13	IO, 1.8V LVDS	Bank2A IO9 differential Positive. Same pin can be configured Single ended I/O.
230	FPGA_AJ16_LVDS2A_18P	LVDS2A_18p/AJ16	IO, 1.8V LVCMOS	Bank2A IO18 Single Ended I/O.
236	FPGA_AM13_LVDS2A_4N	LVDS2A_4n/AM13	IO, 1.8V LVDS	Bank2A IO4 differential Negative. Same pin can be configured Single ended I/O.
238	FPGA_AN13_LVDS2A_4P	LVDS2A_4p/AN13	IO, 1.8V LVDS	Bank2A IO4 differential Positive. Same pin can be configured Single ended I/O.

2.7.3 FPGA IOs & General Purpose Clocks – Bank3A

The Arria10 SoC/FPGA SOM supports upto 22 LVDS IOs/47 Single Ended IOs from Arria10 FPGA Bank3A on Board to Board connector1. In Arria10 SoC/FPGA SOM, Bank3A signals are routed as LVDS IOs to Board to Board Connector1. Even though Bank3A signals are routed as LVDS IOs, these pins can be used as SE IOs if required. Every LVDS pair can be configured as receiver or transmitter and works upto 1.6 Gbps.

In Arria10 SoC/FPGA SOM, upon these 22 LVDS IOs/47 Single Ended IOs from Arria10 FPGA Bank3A, two General Purpose Clock input LVDS pairs and two General Purpose Clock Output LVDS pairs are supported on Board to Board connector1. If Single Ended Clock is required instead of LVDS, then the same LVDS clock pins can be configured as General Purpose single ended clock.

The IO voltage of Bank3A is connected from LDO4 output of the PMIC and supports variable IO voltage setting. IO voltage is configurable from 1.2V to 3.3V through software. While using as LVDS IOs or Single Ended IOs, make sure to set the PMIC LDO4 to output appropriate IO voltage for Bank3A. By default, IO voltage of Bank3A is set as 1.8V.

Arria10 SoC/FPGA SOM Hardware User Guide

For more details on FPGA Bank3A pinouts on Board to Board Connector1, refer the below table.

B2B-1 Pin No	B2B Connector1 Pin Name	SoC Ball Name/ Pin Number	Signal Type/ Termination	Description
10	FPGA_AM7_LVDS3A_24N	LVDS3A_24n/AM7	IO, 1.8V LVCMOS	Bank3A IO24 Single Ended I/O.
12	FPGA_AM1_LVDS3A_16P	LVDS3A_16p/AM1	IO, 1.8V LVDS	Bank3A IO16 differential Positive. Same pin can be configured Single ended I/O.
14	FPGA_AM2_LVDS3A_16N	LVDS3A_16n/AM2	IO, 1.8V LVDS	Bank3A IO16 differential Negative. Same pin can be configured Single ended I/O.
16	FPGA_AP4_LVDS3A_18P	LVDS3A_18p/AP4	IO, 1.8V LVDS	Bank3A IO18 differential Positive. Same pin can be configured Single ended I/O.
18	FPGA_AN4_LVDS3A_18N	LVDS3A_18n/AN4	IO, 1.8V LVDS	Bank3A IO18 differential Negative. Same pin can be configured Single ended I/O.
22	FPGA_AL3_LVDS3A_15N/CLKOUT_0N	LVDS3A_15n/AL3	IO, 1.8V LVDS	Bank3A IO15 differential Negative. Same pin can be configured as Clock0 Output differential Negative or Single ended I/O.
24	FPGA_AM3_LVDS3A_15P/CLKOUT_0P	LVDS3A_15p/AM3	IO, 1.8V LVDS	Bank3A IO15 differential Positive. Same pin can be configured as Clock0 Output differential Negative or Single ended I/O.
27	FPGA_AM6_LVDS3A_17P	LVDS3A_17p/AM6	IO, 1.8V LVDS	Bank3A IO17 differential Positive. Same pin can be configured Single ended I/O.
28	FPGA_AP6_LVDS3A_20N	LVDS3A_20n/AP6	IO, 1.8V LVDS	Bank3A IO20 differential Negative. Same pin can be configured Single ended I/O.
29	FPGA_AM5_LVDS3A_17N	LVDS3A_17n/AM5	IO, 1.8V LVDS	Bank3A IO17 differential Negative. Same pin can be configured Single ended I/O.
30	FPGA_AP7_LVDS3A_20P	LVDS3A_20p/AP7	IO, 1.8V LVDS	Bank3A IO20 differential Positive. Same pin can be configured Single ended I/O.
31	FPGA_AP5_LVDS3A_19P	LVDS3A_19p/AP5	IO, 1.8V LVDS	Bank3A IO19 differential Positive. Same pin can be configured Single ended I/O.
32	FPGA_AL6_LVDS3A_14P	LVDS3A_14p/AL6	IO, 1.8V LVDS	Bank3A IO14 differential Positive. Same pin can be configured Single ended I/O.

Arria10 SoC/FPGA SOM Hardware User Guide

B2B-1 Pin No	B2B Connector1 Pin Name	SoC Ball Name/ Pin Number	Signal Type/ Termination	Description
33	FPGA_AN5_LVDS3A_1 9N	LVDS3A_19n/AN5	IO, 1.8V LVDS	Bank3A IO19 differential Negative. Same pin can be configured Single ended I/O.
34	FPGA_AK6_LVDS3A_1 4N	LVDS3A_14n/AK6	IO, 1.8V LVDS	Bank3A IO14 differential Negative. Same pin can be configured Single ended I/O.
38	FPGA_AK7_LVDS3A_9 P	LVDS3A_9p/AK7	IO, 1.8V LVDS	Bank3A IO9 differential Positive. Same pin can be configured Single ended I/O.
40	FPGA_AK8_LVDS3A_9 N	LVDS3A_9n/AK8	IO, 1.8V LVDS	Bank3A IO9 differential Negative. Same pin can be configured Single ended I/O.
42	FPGA_AJ6_LVDS3A_1 1N	LVDS3A_11n/AJ6	IO, 1.8V LVDS	Bank3A IO11 differential Negative. Same pin can be configured Single ended I/O.
44	FPGA_AJ7_LVDS3A_1 1P	LVDS3A_11p/AJ7	IO, 1.8V LVDS	Bank3A IO11 differential Positive. Same pin can be configured Single ended I/O.
46	FPGA_AH7_LVDS3A_8 P	LVDS3A_8p/AH7	IO, 1.8V LVDS	Bank3A IO8 differential Positive. Same pin can be configured Single ended I/O.
48	FPGA_AG7_LVDS3A_8 N	LVDS3A_8n/AG7	IO, 1.8V LVDS	Bank3A IO8 differential Negative. Same pin can be configured Single ended I/O.
50	FPGA_AH8_LVDS3A_7 P	LVDS3A_7p/AH8	IO, 1.8V LVDS	Bank3A IO7 differential Positive. Same pin can be configured Single ended I/O.
52	FPGA_AG8_LVDS3A_7 N	LVDS3A_7n/AG8	IO, 1.8V LVDS	Bank3A IO7 differential Negative. Same pin can be configured Single ended I/O.
56	FPGA_AL4_LVDS3A_1 3N/CLKIN_ON	LVDS3A_13n/AL4	IO, 1.8V LVDS	Bank3A IO13 differential Negative. Same pin can be configured as Clock0 Input differential Negative or Single ended I/O.
58	FPGA_AL5_LVDS3A_1 3P/CLKIN_OP	LVDS3A_13p/AL5	IO, 1.8V LVDS	Bank3A IO13 differential Positive. Same pin can be configured as Clock0 Input differential Positive or Single ended I/O.
70	FPGA_AG10_LVDS3A_ 4P	LVDS3A_4p/AG10	IO, 1.8V LVDS	Bank3A IO4 differential Positive. Same pin can be configured Single ended I/O.
72	FPGA_AF10_LVDS3A_ 4N	LVDS3A_4n/AF10	IO, 1.8V LVDS	Bank3A IO4 differential Negative. Same pin can be configured Single ended I/O.

Arria10 SoC/FPGA SOM Hardware User Guide

B2B-1 Pin No	B2B Connector1 Pin Name	SoC Ball Name/ Pin Number	Signal Type/ Termination	Description
74	FPGA_AN8_LVDS3A_21P	LVDS3A_21p/AN8	IO, 1.8V LVDS	Bank3A IO21 differential Positive. Same pin can be configured Single ended I/O.
76	FPGA_AM8_LVDS3A_21N	LVDS3A_21n/AM8	IO, 1.8V LVDS	Bank3A IO21 differential Negative. Same pin can be configured Single ended I/O.
78	FPGA_AL9_LVDS3A_23P	LVDS3A_23p/AL9	IO, 1.8V LVCMOS	Bank3A IO23 Single Ended I/O.
82	FPGA_AK9_LVDS3A_12N/CLKIN_1N	LVDS3A_12n/AK9	IO, 1.8V LVDS	Bank3A IO12 differential Negative. Same pin can be configured as Clock1 Input differential Negative or Single ended I/O.
84	FPGA_AJ9_LVDS3A_12P/CLKIN_1P	LVDS3A_12p/AJ9	IO, 1.8V LVDS	Bank3A IO12 differential Positive. Same pin can be configured as Clock1 Input differential Negative or Single ended I/O.
87	FPGA_AF9_LVDS3A_1P	LVDS3A_1p/AF9	IO, 1.8V LVDS	Bank3A IO1 differential Positive. Same pin can be configured Single ended I/O.
88	FPGA_AN9_LVDS3A_22N	LVDS3A_22n/AN9	IO, 1.8V LVDS	Bank3A IO22 differential Negative. Same pin can be configured Single ended I/O.
89	FPGA_AE9_LVDS3A_1N	LVDS3A_1N/AE9	IO, 1.8V LVDS	Bank3A IO1 differential Negative. Same pin can be configured Single ended I/O.
90	FPGA_AP9_LVDS3A_22P	LVDS3A_22p/AP9	IO, 1.8V LVDS	Bank3A IO22 differential Positive. Same pin can be configured Single ended I/O.
91	FPGA_AF8_LVDS3A_2P	LVDS3A_2p/AF8	IO, 1.8V LVDS	Bank3A IO2 differential Positive. Same pin can be configured Single ended I/O.
92	FPGA_AH10_LVDS3A_3P	LVDS3A_3p/AH10	IO, 1.8V LVDS	Bank3A IO3 differential Positive. Same pin can be configured Single ended I/O.
93	FPGA_AE8_LVDS3A_2N	LVDS3A_2n/AE8	IO, 1.8V LVDS	Bank3A IO2 differential Negative. Same pin can be configured Single ended I/O.
94	FPGA_AH9_LVDS3A_3N	LVDS3A_3n/AH9	IO, 1.8V LVDS	Bank3A IO3 differential Negative. Same pin can be configured Single ended I/O.
104	FPGA_AL8_LVDS3A_23N	LVDS3A_23n/AL8	IO, 1.8V LVCMOS	Bank3A IO23 Single Ended I/O.

B2B-1 Pin No	B2B Connector1 Pin Name	SoC Ball Name/ Pin Number	Signal Type/ Termination	Description
106	FPGA_AG11_LVDS3A_5N	LVDS3A_5n/AG11	IO, 1.8V LVDS	Bank3A IO5 differential Negative. Same pin can be configured Single ended I/O.
108	FPGA_AF11_LVDS3A_5P	LVDS3A_5p/AF11	IO, 1.8V LVDS	Bank3A IO5 differential Positive. Same pin can be configured Single ended I/O.
110	FPGA_AE11_LVDS3A_6N	LVDS3A_6n/AE11	IO, 1.8V LVDS	Bank3A IO6 differential Negative. Same pin can be configured Single ended I/O.
112	FPGA_AE12_LVDS3A_6P	LVDS3A_6p/AE12	IO, 1.8V LVDS	Bank3A IO6 differential Positive. Same pin can be configured Single ended I/O.
116	FPGA_AH5_LVDS3A_10N/CLKOUT_1N	LVDS3A_10n/AH5	IO, 1.8V LVDS	Bank3A IO10 differential Negative. Same pin can be configured as Clock1 Output differential Negative or Single ended I/O.
118	FPGA_AJ5_LVDS3A_10P/CLKOUT_1P	LVDS3A_10p/AJ5	IO, 1.8V LVDS	Bank3A IO10 differential Positive. Same pin can be configured as Clock1 Output differential Positive or Single ended I/O.

2.8 Board to Board connector2 Interfaces

The Arria10 SoC/FPGA SOM supports two 240pin High speed ground plane ruggedized terminal strip connectors for interfaces expansion. The interfaces which are available at 240pin Board to Board connector2 from Arria10 HPS and FPGA fabric are explained in the following sections.

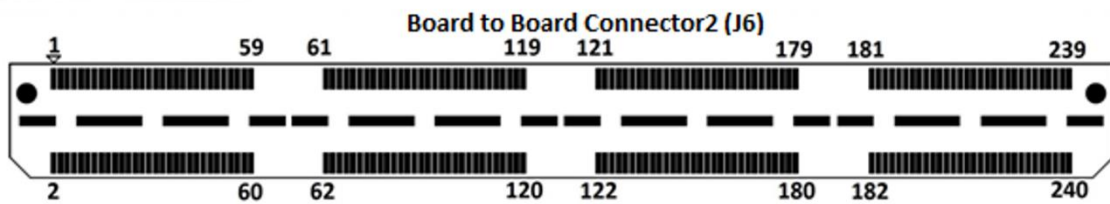
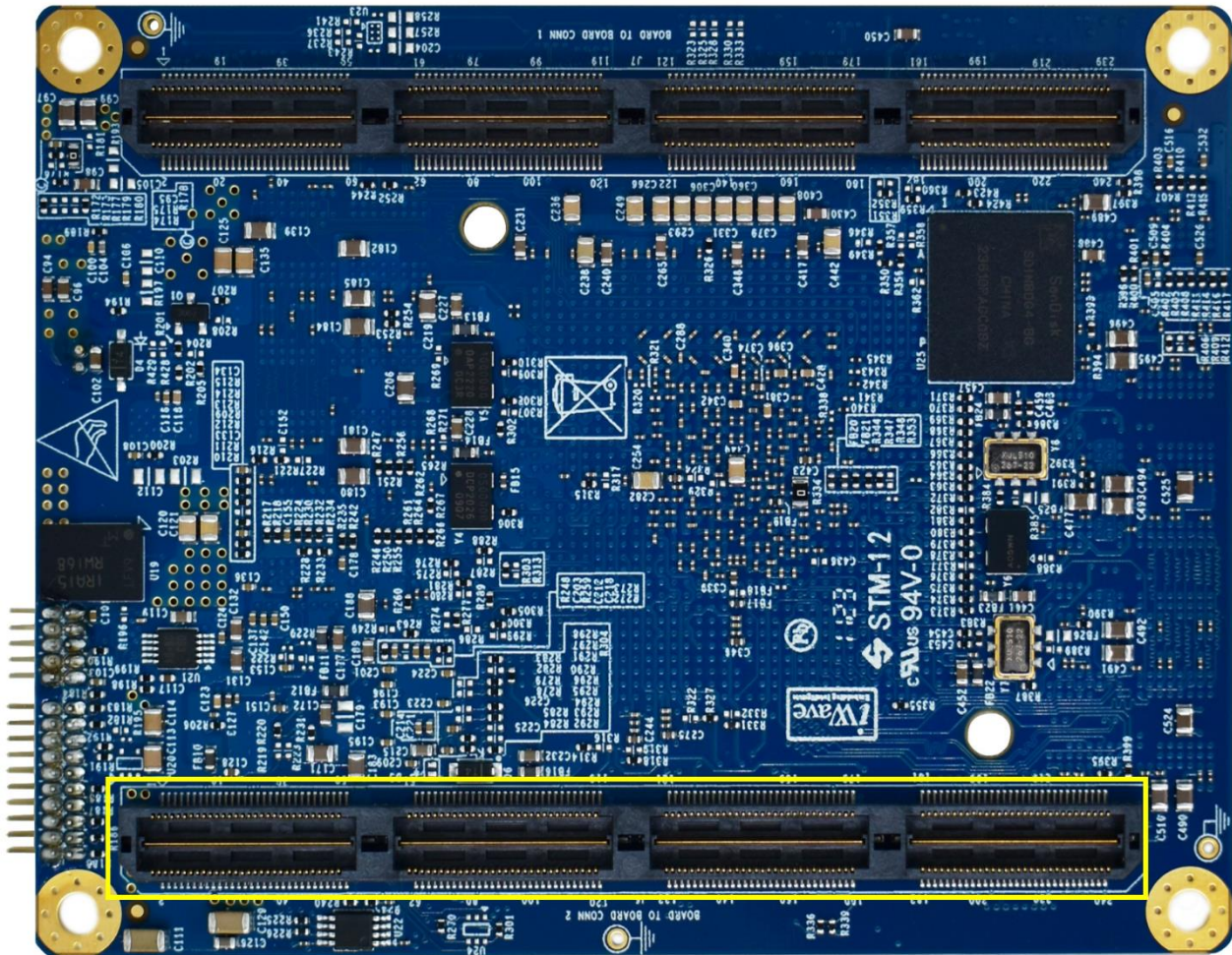

Figure 9: Board to Board Connector2

- Number of Pins - 240
- Connector Part Number- QTH-120-01-L-D-A
- Mating Connector - QSH-120-01-L-D-A from Samtech
- Staking Height - 5mm

Table 10: Board to Board Connector2 Pinout

Signal	B2B-2 Pin	B2B-2 Pin	Signal
VCC_5V	1	2	VCC_5V
VCC_5V	3	4	VCC_5V
VCC_5V	5	6	VCC_5V
VCC_5V	7	8	VCC_5V
VCC_5V	9	10	VCC_5V
VCC_5V	11	12	VCC_5V
VCC_5V	13	14	VCC_5V
VCC_5V	15	16	VCC_5V
VCC_5V	17	18	VCC_5V
VCC_5V	19	20	VCC_5V
GND	21	22	GND
GND	23	24	GND
CSS_TRST	25	26	USB_OTG_DM
CSS_TDI	27	28	USB_OTG_DP
CSS_TMS	29	30	GND
CSS_TCK	31	32	USB_PWR_EN
CSS_TDO	33	34	USB_OTG_ID
RESET_SW_IN	35	36	VBUS_USB
GND	37	38	HPS_GPIO4(GPIO0_IO10)
GPHY_DTXRXM	39	40	HPS_GPIO1/EMAC2_RXD1(GPIO1_IO19)
GPHY_DTXRXP	41	42	HPS_GPIO2/EMAC2_RXD0(GPIO1_IO18)
GND	43	44	HPS_GPIO3(GPIO0_IO11)
GPHY_CTXRXM	45	46	HPS_GPIO0_IO4/I2C0_SDA
GPHY_CTXRXP	47	48	HPS_GPIO0_IO5/I2C0_SCL
GND	49	50	HPS_GPIO0_IO6/EMAC2_MDIO
GPHY_BTXRXM	51	52	HPS_GPIO0_IO7/EMAC2_MDC
GPHY_BTXRXP	53	54	HPS_D_UART1_TX
GND	55	56	HPS_D_UART1_RX
GPHY_ATRXRXM	57	58	B_GPHY_LINK_LED2
GPHY_ATXRXP	59	60	B_GPHY_ACTIVITY_LED1
HPS_SPIM0_CLK/EMAC2_TXD2	61	62	HPS_SDMMC_DATA3/EMAC2_TXD1
HPS_SPIM0_SS0_N/EMAC2_RXD3	63	64	HPS_SDMMC_DATA2/EMAC2_TXD0
HPS_SPIM0_MOSI/EMAC2_TXD3	65	66	HPS_SDMMC_DATA1/EMAC2_RX_CTL
HPS_SPIM0_MISO/EMAC2_RXD2	67	68	HPS_GPIO0_IO0
HPS_SDMMC_DATA0	69	70	HPS_GPIO0_IO1
HPS_SDMMC_CMD	71	72	HPS_SDMMC_CCLK/EMAC2_RX_CLK
GND	73	74	GND
FPGA_AC10_LVDS3B_9N	75	76	FPGA_AB8_LVDS3B_4P
FPGA_AC9_LVDS3B_9P	77	78	FPGA_AB7_LVDS3B_4N
FPGA_AF6_LVDS3B_17N	79	80	FPGA_AE7_LVDS3B_11N

Arria10 SoC/FPGA SOM Hardware User Guide

Signal	B2B-2 Pin	B2B-2 Pin	Signal
FPGA_AG6_LVDS3B_17P	81	82	FPGA_AE6_LVDS3B_11P
FPGA_AF5_LVDS3B_14N	83	84	FPGA_AD6_LVDS3B_8N
FPGA_AG5_LVDS3B_14P	85	86	FPGA_AD5_LVDS3B_8P
FPGA_AK4_LVDS3B_22P	87	88	FPGA_AD7_LVDS3B_7P
FPGA_AK3_LVDS3B_22N	89	90	FPGA_AC7_LVDS3B_7N
FPGA_AJ4_LVDS3B_21P	91	92	FPGA_AH3_LVDS3B_18P
FPGA_AH4_LVDS3B_21N	93	94	FPGA_AG3_LVDS3B_18N
FPGA_AL1_LVDS3B_24P	95	96	FPGA_AG2_LVDS3B_19N
FPGA_AK1_LVDS3B_24N	97	98	FPGA_AG1_LVDS3B_19P
FPGA_AK2_LVDS3B_23P	99	100	FPGA_AE4_LVDS3B_3P
FPGA_AJ2_LVDS3B_23N	101	102	FPGA_AD4_LVDS3B_3N
FPGA_AJ1_LVDS3B_20P	103	104	FPGA_AF1_LVDS3B_16P
FPGA_AH2_LVDS3B_20N	105	106	FPGA_AE1_LVDS3B_16N
GND	107	108	GND
FPGA_AD10_LVDS3B_12P/CLKIN_1P	109	110	FPGA_AC8_LVDS3B_10P/CLKOUT_1P
FPGA_AD11_LVDS3B_12N/CLKIN_1N	111	112	FPGA_AD9_LVDS3B_10N/CLKOUT_1N
GND	113	114	GND
FPGA_AF4_LVDS3B_15P/CLKOUT_0P	115	116	FPGA_AE2_LVDS3B_13P/CLK13_0P
FPGA_AF3_LVDS3B_15N/CLKOUT_0N	117	118	FPGA_AE3_LVDS3B_13N/CLKIN_0N
GND	119	120	GND
FPGA_AB11_LVDS3B_1N	121	122	FPGA_AD2_LVDS3B_2P
FPGA_AB10_LVDS3B_1P	123	124	FPGA_AD1_LVDS3B_2N
FPGA_AB5_LVDS3B_5N	125	126	FPGA_AC4_LVDS3B_6P
FPGA_AB6_LVDS3B_5P	127	128	FPGA_AC5_LVDS3B_6N
GND	129	130	GND
FPGA_AB1_LVDS3C_24P	131	132	FPGA_AC3_LVDS3C_22P
FPGA_AA1_LVDS3C_24N	133	134	FPGA_AC2_LVDS3C_22N
FPGA_AA3_LVDS3C_20P	135	136	FPGA_AB2_LVDS3C_21P
FPGA_AA4_LVDS3C_20N	137	138	FPGA_AB3_LVDS3C_21N
FPGA_Y1_LVDS3C_23P	139	140	FPGA_AA8_LVDS3C_17P
FPGA_Y2_LVDS3C_23N	141	142	FPGA_AA9_LVDS3C_17N
FPGA_V3_LVDS3C_9N	143	144	FPGA_Y3_LVDS3C_19P
FPGA_U3_LVDS3C_9P	145	146	FPGA_Y4_LVDS3C_19N
FPGA_V2_LVDS3C_11P	147	148	FPGA_V5_LVDS3C_6P
FPGA_U2_LVDS3C_11N	149	150	FPGA_V4_LVDS3C_6N
FPGA_U6_LVDS3C_5P	151	152	FPGA_W6_LVDS3C_16P
FPGA_U5_LVDS3C_5N	153	154	FPGA_W7_LVDS3C_16N

Arria10 SoC/FPGA SOM Hardware User Guide

Signal	B2B-2 Pin	B2B-2 Pin	Signal
FPGA_T4_LVDS3C_1P	155	156	FPGA_Y8_LVDS3C_14
FPGA_R4_LVDS3C_1N	157	158	FPGA_Y9_LVDS3C_14N
FPGA_R1_LVDS3C_8P	159	160	FPGA_R3_LVDS3C_3N
FPGA_P1_LVDS3C_8N	161	162	FPGA_T3_LVDS3C_3P
FPGA_P2_LVDS3C_7P	163	164	FPGA_P4_LVDS3C_2P
FPGA_R2_LVDS3C_7N	165	166	FPGA_P5_LVDS3C_2N
GND	167	168	GND
FPGA_U1_LVDS3C_10P/CLKOUT_1 P	169	170	FPGA_W4_LVDS3C_15P/CLKOUT_0P
FPGA_T1_LVDS3C_10N/CLKOUT_1 N	171	172	FPGA_W5_LVDS3C_15N/CLKOUT_0N
GND	173	174	GND
FPGA_W1_LVDS3C_12P/CLKIN_1P	175	176	FPGA_Y6_LVDS3C_13P/CLKIN_0P
FPGA_W2_LVDS3C_12N/CLKIN_1N	177	178	FPGA_Y7_LVDS3C_13N/CLKIN_0N
GND	179	180	GND
FPGA_T6_LVDS3C_4N	181	182	FPGA_AA5_LVDS3C_18P
FPGA_T5_LVDS3C_4P	183	184	FPGA_AA6_LVDS3C_18N
GND	185	186	GND
GXBL1F_RX_CH0P	187	188	REFCLK_GXBL1F_CHTP
GXBL1F_RX_CH0N	189	190	REFCLK_GXBL1F_CHTN
GND	191	192	GND
GXBL1F_TX_CH0P	193	194	GXBL1F_RX_CH3P
GXBL1F_TX_CH0N	195	196	GXBL1F_RX_CH3N
GND	197	198	GND
GXBL1F_RX_CH1P	199	200	GXBL1F_TX_CH3P
GXBL1F_RX_CH1N	201	202	GXBL1F_TX_CH3N
GND	203	204	GND
GXBL1F_TX_CH1P	205	206	GXBL1F_RX_CH4P
GXBL1F_TX_CH1N	207	208	GXBL1F_RX_CH4N
GND	209	210	GND
GXBL1F_RX_CH2P	211	212	GXBL1F_TX_CH4P
GXBL1F_RX_CH2N	213	214	GXBL1F_TX_CH4N
GND	215	216	GND
GXBL1F_TX_CH2P	217	218	GXBL1F_RX_CH5P
GXBL1F_TX_CH2N	219	220	GXBL1F_RX_CH5N
GND	221	222	GND
REFCLK_GXBL1F_CHBP	223	224	GXBL1F_TX_CH5P
REFCLK_GXBL1F_CHBN	225	226	GXBL1F_TX_CH5N
GND	227	228	GND
GXBL1E_RX_CH4P	229	230	GXBL1E_RX_CH5P
GXBL1E_RX_CH4N	231	232	GXBL1E_RX_CH5N

Signal	B2B-2 Pin	B2B-2 Pin	Signal
GND	233	234	GND
GXBL1E_TX_CH4P	235	236	GXBL1E_TX_CH5P
GXBL1E_TX_CH4N	237	238	GXBL1E_TX_CH5N
GND	239	240	GND

2.8.1 HPS Interfaces

The interfaces which are supported in Board to Board Connector2 from Arria10 SoC/FPGA SOM is explained in the following section.

2.8.1.1 HPS Gigabit Ethernet

The Arria10 SoC SOM supports one 10/100/1000Mbps Ethernet interface on Board to Board connector2 through EMAC1 interface from HPS shared I/O pins. The MAC is integrated in the Arria10 SoC's HPS and connected to the external Ethernet PHY on SOM. Since MAC and PHY are supported on SOM itself, only Magnetics are required on the carrier board. Arria10 SoC SOM also supports Link and Activity indication LED control signals to Board to Board Connector2.

The Arria10 SoC SOM supports "KSZ9031RNX" Ethernet PHY from Microchip. This PHY is interfaced with Arria10 HPS's Ethernet Media Access controller and works at 3.3V IO voltage level. Since this PHY doesn't recommend connecting any power source to magnetic centre tap pins, CTREF voltage to Board to Board Connector2 is not supported on SOM. It is recommended that centre tap pins of magnetics should be separated from one another and connected through separate 0.1uF common mode capacitors to ground. This PHY has on-chip termination on differential pairs and so no need to add any termination externally.

For more details on HPS Gigabit Ethernet pinouts on Board to Board Connector2, refer the below table.

B2B-2 Pin No	B2B Connector2 Pin Name	SoC Ball Name/ Pin Number	Signal Type/ Termination	Description
39	GPHY_DTXRXM	NA	IO, GBE	Gigabit Ethernet differential pair 4 negative.
41	GPHY_DTXRXP	NA	IO, GBE	Gigabit Ethernet differential pair 4 positive.
45	GPHY_CTXRXM	NA	IO, GBE	Gigabit Ethernet differential pair 3 negative.
47	GPHY_CTXRXP	NA	IO, GBE	Gigabit Ethernet differential pair 3 positive.
51	GPHY_BTXRXM	NA	IO, GBE	Gigabit Ethernet differential pair 2 negative.
53	GPHY_BTXRXP	NA	IO, GBE	Gigabit Ethernet differential pair 2 positive.

B2B-2 Pin No	B2B Connector2 Pin Name	SoC Ball Name/ Pin Number	Signal Type/ Termination	Description
57	GPHY_ATXRXM	NA	IO, GBE	Gigabit Ethernet differential pair 1 negative.
59	GPHY_ATXRX	NA	IO, GBE	Gigabit Ethernet differential pair 1 positive.
58	GPHY_LINK_LED2	NA	O, 1.8V CMOS/ 10K PU	Gigabit Ethernet 1000Mbps Link status LED
60	GPHY_ACTIVITY_LED1	NA	O, 1.8V CMOS/ 1K PD	Gigabit Ethernet Activity LED

2.8.1.2 HPS USB2.0 OTG interface

The Arria10 SoC SOM supports one USB2.0 OTG interface on Board to Board connector2 through HPS shared I/O pins. Arria10 SoC HPS's USB1 OTG Controller is used for USB2.0 OTG interface. This USB OTG Controller supports a single USB port connected through a USB 2.0 Transceiver Macrocell Plus Low Pin Interface compliant PHY. Also this controller supports all high-speed, full-speed and low-speed transfers in both device and host modes.

The Arria10 SoC SOM supports "USB3320" ULPI transceiver from Microchip. The ULPI interface from HPS USB1 OTG controller is connected to this PHY. USB3320 PHY uses the industry standard UTMI+ Low Pin Interface to connect the USB Transceiver to the link. The Arria10 SoC SOM supports active high power enable signal on Board to Board connector2 from this USB PHY for external Vbus power control. Also, it supports USB ID input and USB Vbus from Board to Board connector2 and connected to USB PHY for USB host or device detection. If USB ID pin is grounded, then USB Host is detected and if it is floated, USB device is detected.

For more details on USB2.0 OTG Interface pinouts on Board to Board Connector2, refer the below table.

B2B-2 Pin No	B2B Connector2 Pin Name	SoC Ball Name/ Pin Number	Signal Type/ Termination	Description
26	USB_OTG_DM	NA	IO, USB	USB OTG data negative.
28	USB_OTG_DP	NA	IO, USB	USB OTG data positive.
32	USB_PWR_EN	NA	O, 3.3V CMOS	USB active high power enable output to control external USB Vbus.
34	USB_OTG_ID	NA	I, 3.3V CMOS	USB OTG ID input for USB host or device detection.
36	VBUS_USB	NA	I, 5V Power	USB VBUS for VBUS monitoring.

2.8.1.3 HPS Debug UART Interface

The Arria10 SoC HPS supports UART controllers for asynchronous serial communication. The UART controllers are based on industry standard 16550 UART Controller.

The Arria10 SoC SOM supports one Debug UART interface on Board to Board Connector2. The UART1 controller of Arria10 SoC HPS is used for Debug UART interface through Dedicated HPS pins. This controller is used for Debug UART interface with Transmit & Receive signal on Board to Board connector2.

For more details on Debug UART pinouts on Board to Board Connector2, refer the below table.

B2B-2 Pin No	B2B Connector2 Pin Name	SoC Ball Name/ Pin Number	Signal Type/ Termination	Description
54	HPS_D_UART1_TX	GPIO2_IO12/ F15	O, 1.8V LVCMOS	UART1 Transmit data line for Debug.
56	HPS_D_UART1_RX	GPIO2_IO13/ H15	I, 1.8V LVCMOS	UART1 Receive data line for Debug.

2.8.1.4 HPS SPI Interface

The Arria10 SoC SOM supports one SPI Master interface with one chip select on Board to Board connector2 through HPS shared I/O pins. Arria10 HPS's SPI controller is used for SPI Master interface which supports full-duplex synchronous four-wire serial interface with DMA. Each SPI master has a maximum bit rate of 60Mbps.

Arria10 HPS's SPI controller has programmable choice of Serial interface protocols Motorola SPI protocol or Texas Instruments Synchronous Serial Protocol or National Semiconductor Microwire. It has transmit and receive FIFO buffers which are 256 words deep. Also, it supports DMA controller interface integrated with HPS DMA controller.

For more details on SPI Interface pinouts on Board to Board Connector2, refer the below table.

B2B-2 Pin No	B2B Connector2 Pin Name	SoC Ball Name/ Pin Number	Signal Type/ Termination	Description
61	HPS_SPIM0_CLK/EMAC2_TXD2	SPIM0_CLK/ B21	O, 1.8V LVCMOS	SPI clock.
63	HPS_SPIM0_SS0_N/EMAC2_RXD3	SPIM0_SS0_N/ D19	O, 1.8V LVCMOS	SPI chip select0.
65	HPS_SPIM0_MOSI/EMAC2_TXD3	SPIM0_MOSI/ B20	IO, 1.8V LVCMOS	SPI Master output Slave input.
67	HPS_SPIM0_MISO/EMAC2_RXD2	SPIM0_MISO/ C19	IO, 1.8V LVCMOS	SPI Master input Slave output.

2.8.1.5 HPS I2C Interface

The Arria10 SoC SOM supports one I2C interface on Board to Board Connector2 through HPS shared I/O pins. Arria10 SoC HPS's I2C0 controller is used for I2C interface which is compatible with the standard NXP I2C bus protocol. It supports standard mode with data transfer rates up to 100kbps and Fast mode with data transfer rates up to 400kbps. I2C controller must be programmed to operate in either master or slave mode only. Operating as a master and slave simultaneously is not supported.

For more details on I2C Interface pinouts on Board to Board Connector2, refer the below table.

B2B-2 Pin No	B2B Connector2 Pin Name	SoC Ball Name/ Pin Number	Signal Type/ Termination	Description
46	HPS_GPIO0_IO4/I2C0_SDA	GPIO0_IO4/ M21	IO, 1.8V OD/ 4.7K PU	I2C0 data.
48	HPS_GPIO0_IO5/I2C0_SCL	GPIO0_IO5/ L21	O, 1.8V OD/ 4.7K PU	I2C0 clock.

2.8.1.6 HPS GPIO Interface

The Arria10 SoC SOM supports GPIOs on Board to Board connector2. The Arria10 SoC's HPS I/O block supports Dedicated I/O and Shared I/O. Dedicated I/O pins are used for HPS boot devices and other key peripherals. Shared I/O pins are used for other HPS interfaces and can be selected through I/O multiplexing. These shared I/O pins are divided into four quadrants of 12 signals per quadrant. Each quadrant can be assigned to either HPS or the FPGA fabric. All the interface pins from HPS Shared I/O pins can be used as GPIO if not used as other interface.

The Arria10 HPS's GPIO module provides general-purpose pins that can be configured as either input or output. When configured as an output, it is possible to write to an internal register to control the state driven on the output pin. When configured as an input, it is possible to detect the state of the input by reading the state of an internal register. In addition, the GPIO input can produce interrupt to the HPS core via the interrupt control block when corresponding registers are set. Also it supports digital de-bounce where the external signal can be debounced to remove any spurious glitches that are less than one period of the external debouncing clock.

For more details on GPIO Interface pinouts on Board to Board Connector2, refer the below table.

B2B-2 Pin No	B2B Connector2 Pin Name	SoC Ball Name/ Pin Number	Signal Type/ Termination	Description
38	HPS_GPIO4(GPIO0_IO10)	GPIO0_IO10/ L20	IO, 1.8V CMOS	General Purpose Input/Output.
40	HPS_GPIO1/EMAC2_RXD1(GPIO1_IO19)	GPIO1_IO19/ A21	IO, 1.8V CMOS	General Purpose Input/Output.
42	HPS_GPIO2/EMAC2_RXD0(GPIO1_IO18)	GPIO1_IO18/ B22	IO, 1.8V CMOS	General Purpose Input/Output.

B2B-2 Pin No	B2B Connector2 Pin Name	SoC Ball Name/ Pin Number	Signal Type/ Termination	Description
44	HPS_GPIO3(GPIO0_IO11)	GPIO0_IO11/ M20	IO, 1.8V CMOS	General Purpose Input/Output.
50	HPS_GPIO0_IO6/EMAC2_MDI	GPIO0_IO6/ K21	IO, 1.8V CMOS	General Purpose Input/Output.
52	HPS_GPIO0_IO7/EMAC2_MDC	GPIO0_IO7/ J21	IO, 1.8V CMOS	General Purpose Input/Output.
62	HPS_SDMMC_DATA3/EMAC2_TXD1	GPIO1_IO17/ A20	IO, 1.8V CMOS	General Purpose Input/Output.
64	HPS_SDMMC_DATA2/EMAC2_TXD0	GPIO1_IO16/ A19	IO, 1.8V CMOS	General Purpose Input/Output.
66	HPS_SDMMC_DATA1/EMAC2_RX_CTL	GPIO1_IO15/ B18	IO, 1.8V CMOS	General Purpose Input/Output.
68	HPS_GPIO0_IO0	GPIO0_IO0/ M17	IO, 1.8V CMOS	General Purpose Input/Output.
69	HPS_SDMMC_DATA0	GPIO1_IO12/ C18	IO, 1.8V CMOS	General Purpose Input/Output.
70	HPS_GPIO0_IO1	GPIO0_IO1/ M18	IO, 1.8V CMOS	General Purpose Input/Output.
71	HPS_SDMMC_CMD	GPIO1_IO13/ D17	IO, 1.8V CMOS	General Purpose Input/Output.
72	HPS_SDMMC_CCLK/EMAC2_RX_CLK	GPIO1_IO14/ A18	IO, 1.8V CMOS	General Purpose Input/Output.

2.8.1.7 HPS Warm Reset

The Arria10 SoC SOM supports Warm reset pin on Board to Board connector2. This Warm reset from Board to Board connector2 is connected to HPS_nRST pin of the Arria10 SoC. This is active low bi-directional pin and can initiate the warm reset when driven low from the carrier board by connecting the reset push button switch. In HPS warm reset, all of the HPS except security manager, POR, Fuse Logic and test access port (TAP) and Debug domains are reset. While HPS cold reset, HPS drives out this pin low.

For more details on Warm Reset Interface pinouts on Board to Board Connector2, refer the below table.

B2B-2 Pin No	B2B Connector2 Pin Name	SoC Ball Name/ Pin Number	Signal Type/ Termination	Description
35	HPS_nRST	HPS_nRST/ L14	I, 1.8V CMOS/ 1K PU	Warm reset input to HPS block.

2.8.1.8 JTAG Interface

The Arria10 SoC/FPGA SOM supports JTAG interface on Board to Board connector2. The Arria10 SoC's HPS and FPGA share a common set of JTAG pins and each have their own TAP controller which are chained together inside the Arria10 device. During power- on-reset, the JTAG and all debug fuses are read by the Configuration subsystem to determine if the JTAG to the FPGA or HPS is bypassed. These JTAG interface signals are also connected to on-board JTAG connector.

For more details on JTAG Interface pinouts on Board to Board Connector2, refer the below table.

B2B-2 Pin No	B2B Connector2 Pin Name	SoC Ball Name/ Pin Number	Signal Type/ Termination	Description
25	CSS_TRST	CSS_TRST/ AL11	I, 1.8V CMOS/ 10K PU	JTAG test reset input pin.
27	CSS_TDI	CSS_TDI/ AH13	I, 1.8V CMOS/ 10K PU	JTAG Test Data Input.
29	CSS_TMS	CSS_TMS/ AL10	I, 1.8V CMOS/ 10K PU	JTAG Test Mode Select.
31	CSS_TCK	CSS_TCK/ AH12	I, 1.8V CMOS	JTAG Test Clock.
33	CSS_TDO	CSS_TDO/ AJ12	O, 1.8V CMOS	JTAG Test Data Output.

2.8.2 FPGA Interfaces

2.8.2.1 FPGA High Speed Transceivers

The Arria10 SoC/FPGA SOM supports 8 high speed transceiver channels (2 from 1E bank & 6 from 1F bank) on Board to Board connector2. In Arria10 SoC/FPGA SOM, Transceiver power to Arria10 SoC/FPGA is fixed to 1.03V. Also it supports 100MHz Oscillator on board for transceiver reference clock and connected to Bank2A AK16 CLKUSR pin.

For more details on High Speed transceiver pinouts on Board to Board Connector2, refer the below table.

B2B-2 Pin No	B2B Connector2 Pin Name	SoC Ball Name/ Pin Number	Signal Type/ Termination	Description
BANK 1F Channels				
193	GXBL1F_TX_CH0P	GXBL1F_TX_CH0P/ E34	O, DIFF	Bank1F channel0 High speed differential transmitter positive.
195	GXBL1F_TX_CH0N	GXBL1F_TX_CH0N/ E33	O, DIFF	Bank1F channel0 High speed differential transmitter Negative.
187	GXBL1F_RX_CH0P	GXBL1F_RX_CH0P/ L30	I, DIFF	Bank1F channel0 High speed differential receiver positive.
189	GXBL1F_RX_CH0N	GXBL1F_RX_CH0N/ L29	I, DIFF	Bank1F channel0 High speed differential receiver Negative.
205	GXBL1F_TX_CH1P	GXBL1F_TX_CH1P/ C34	O, DIFF	Bank1F channel1 High speed differential transmitter positive.
207	GXBL1F_TX_CH1N	GXBL1F_TX_CH1N/ C33	O, DIFF	Bank1F channel1 High speed differential transmitter Negative.
199	GXBL1F_RX_CH1P	GXBL1F_RX_CH1P/ K32	I, DIFF	Bank1F channel1 High speed differential receiver positive.
201	GXBL1F_RX_CH1N	GXBL1F_RX_CH1N/ K31	I, DIFF	Bank1F channel1 High speed differential receiver Negative.
217	GXBL1F_TX_CH2P	GXBL1F_TX_CH2P/ H32	O, DIFF	Bank1F channel2 High speed differential transmitter positive.
219	GXBL1F_TX_CH2N	GXBL1F_TX_CH2N/ H31	O, DIFF	Bank1F channel2 High speed differential transmitter Negative.
211	GXBL1F_RX_CH2P	GXBL1F_RX_CH2P/ J30	I, DIFF	Bank1F channel2 High speed differential receiver positive.
213	GXBL1F_RX_CH2N	GXBL1F_RX_CH2N/ J29	I, DIFF	Bank1F channel2 High speed differential receiver Negative.
200	GXBL1F_TX_CH3P	GXBL1F_TX_CH3P/ F32	O, DIFF	Bank1F channel3 High speed differential transmitter positive.
202	GXBL1F_TX_CH3N	GXBL1F_TX_CH3N/ F31	O, DIFF	Bank1F channel3 High speed differential transmitter Negative.
194	GXBL1F_RX_CH3P	GXBL1F_RX_CH3P/ G30	I, DIFF	Bank1F channel3 High speed differential receiver positive.

Arria10 SoC/FPGA SOM Hardware User Guide

B2B-2 Pin No	B2B Connector2 Pin Name	SoC Ball Name/ Pin Number	Signal Type/ Termination	Description
196	GXBL1F_RX_CH3N	GXBL1F_RX_CH3N/ G29	I, DIFF	Bank1F channel3 High speed differential receiver Negative.
212	GXBL1F_TX_CH4P	GXBL1F_TX_CH4P/ D32	O, DIFF	Bank1F channel4 High speed differential transmitter positive.
214	GXBL1F_TX_CH4N	GXBL1F_TX_CH4N/ D31	O, DIFF	Bank1F channel4 High speed differential transmitter Negative.
206	GXBL1F_RX_CH4P	GXBL1F_RX_CH4P/ E30	I, DIFF	Bank1F channel4 High speed differential receiver positive.
208	GXBL1F_RX_CH4N	GXBL1F_RX_CH4N/ E29	I, DIFF	Bank1F channel4 High speed differential receiver Negative.
224	GXBL1F_TX_CH5P	GXBL1F_TX_CH5P/ B32	O, DIFF	Bank1F channel5 High speed differential transmitter positive.
226	GXBL1F_TX_CH5N	GXBL1F_TX_CH5N/ B31	O, DIFF	Bank1F channel5 High speed differential transmitter Negative.
218	GXBL1F_RX_CH5P	GXBL1F_RX_CH5P/ C30	I, DIFF	Bank1F channel5 High speed differential receiver positive.
220	GXBL1F_RX_CH5N	GXBL1F_RX_CH5N/ C29	I, DIFF	Bank1F channel5 High speed differential receiver Negative.
223	REFCLK_GXBL1F_CHBP	REFCLK_GXBL1F_CHB P/P28	I, DIFF	Bank1F differential Bottom reference clock positive.
225	REFCLK_GXBL1F_CHBN	REFCLK_GXBL1F_CHB N/P27	I, DIFF	Bank1F differential Bottom reference clock Negative.
188	REFCLK_GXBL1F_CHTP	REFCLK_GXBL1F_CHT P/M28	I, DIFF	Bank1F differential Top reference clock positive.
190	REFCLK_GXBL1F_CHTN	REFCLK_GXBL1F_CHT N/M27	I, DIFF	Bank1F differential Top reference clock Negative.
BANK 1E Channels				
235	GXBL1E_TX_CH4P	GXBL1E_TX_CH4p/ J34	O, DIFF	Bank1E channel4 High speed differential transmitter positive.
237	GXBL1E_TX_CH4N	GXBL1E_TX_CH4n/ J33	O, DIFF	Bank1E channel4 High speed differential transmitter Negative.
229	GXBL1E_RX_CH4P	GXBL1E_RX_CH4p/ N30	I, DIFF	Bank1E channel4 High speed differential receiver positive.
231	GXBL1E_RX_CH4N	GXBL1E_RX_CH4n/ N29	I, DIFF	Bank1E channel4 High speed differential receiver Negative.
236	GXBL1E_TX_CH5P	GXBL1E_TX_CH5p/ G34	O, DIFF	Bank1F channel5 High speed differential transmitter positive.
238	GXBL1E_TX_CH5N	GXBL1E_TX_CH5n/ G33	O, DIFF	Bank1F channel5 High speed differential transmitter Negative.
230	GXBL1E_RX_CH5P	GXBL1E_RX_CH5p/ M32	I, DIFF	Bank1F channel5 High speed differential receiver positive.

B2B-2 Pin No	B2B Connector2 Pin Name	SoC Ball Name/ Pin Number	Signal Type/ Termination	Description
232	GXBL1E_RX_CH5N	GXBL1E_RX_CH5n/ M31	I, DIFF	Bank1F channel5 High speed differential receiver Negative.

2.8.2.2 FPGA IOs & General Purpose Clocks – Bank3B

The Arria10 SoC/FPGA SOM supports upto 24 LVDS IOs pairs from Arria10 FPGA Bank3B on Board to Board connector2. These Bank3B signals on Board to Board connector2 is routed as LVDS IO pairs in the board. Every LVDS pair can be configured as receiver or transmitter and works upto 1.6 Gbps. If the Single Ended IOs are required in these pins, it may also be configured even though the signals are routed as LVDS IOs.

In Arria10 SoC/FPGA SOM, upon these 24 LVDS IO pairs from Arria10 FPGA Bank3B, two General Purpose Clock input LVDS pairs and two General Purpose Clock Output LVDS pairs are supported on Board to Board connector2. If Single Ended Clock is required instead of LVDS, then the same LVDS clock pins can be configured as General Purpose single ended clock.

The IO voltage of Bank3B is connected from LDO2 output of the PMIC and supports variable IO voltage setting. IO voltage is configurable from 1.2V to 3.3V through software. While using as LVDS IOs or Single Ended IOs, make sure to set the PMIC LDO2 to output appropriate IO voltage for Bank3B. By default, IO voltage of Bank3B is set as 1.8V.

For more details on Bank3B FPGA pinouts on Board to Board Connector2, refer the below table.

B2B-2 Pin No	B2B Connector2 Pin Name	SoC Ball Name/ Pin Number	Signal Type/ Termination	Description
75	FPGA_AC10_LVDS3B_9n	LVDS3B_9n/AC10	IO, 1.8V LVDS	Bank3B IO9 differential Negative. Same pin can be configured Single ended I/O.
76	FPGA_AB8_LVDS3B_4p	LVDS3B_4p/AB8	IO, 1.8V LVDS	Bank3B IO4 differential Positive. Same pin can be configured Single ended I/O.
77	FPGA_AC9_LVDS3B_9p	LVDS3B_9p/AC9	IO, 1.8V LVDS	Bank3B IO9 differential Positive. Same pin can be configured Single ended I/O
78	FPGA_AB7_LVDS3B_4n	LVDS3B_4n/AB7	IO, 1.8V LVDS	Bank3B IO4 differential Negative. Same pin can be configured Single ended I/O.
79	FPGA_AF6_LVDS3B_17n	LVDS3B_17n/AF6	IO, 1.8V LVDS	Bank3B IO17 differential Negative. Same pin can be configured Single ended I/O.
80	FPGA_AE7_LVDS3B_11n	LVDS3B_11n/AE7	IO, 1.8V LVDS	Bank3B IO11 differential Negative. Same pin can be configured Single ended I/O.

Arria10 SoC/FPGA SOM Hardware User Guide

B2B-2 Pin No	B2B Connector2 Pin Name	SoC Ball Name/ Pin Number	Signal Type/ Termination	Description
81	FPGA_AG6_LVDS3B_1 7p	LVDS3B_17p/AG6	IO, 1.8V LVDS	Bank3B IO17 differential Positive. Same pin can be configured Single ended I/O.
82	FPGA_AE6_LVDS3B_1 1p	LVDS3B_11p/AE6	IO, 1.8V LVDS	Bank3B IO11 differential Positive. Same pin can be configured Single ended I/O.
83	FPGA_AF5_LVDS3B_1 4n	LVDS3B_14n/AF5	IO, 1.8V LVDS	Bank3B IO14 differential Negative. Same pin can be configured Single ended I/O.
84	FPGA_AD6_LVDS3B_8 n	LVDS3B_8n/AD6	IO, 1.8V LVDS	Bank3B IO8 differential Negative. Same pin can be configured Single ended I/O.
85	FPGA_AG5_LVDS3B_1 4p	LVDS3B_14p/AG5	IO, 1.8V LVDS	Bank3B IO14 differential Positive. Same pin can be configured Single ended I/O.
86	FPGA_AD5_LVDS3B_8 p	LVDS3B_8p/AD5	IO, 1.8V LVDS	Bank3B IO8 differential Positive. Same pin can be configured Single ended I/O.
87	FPGA_AK4_LVDS3B_2 2p	LVDS3B_22p/AK4	IO, 1.8V LVDS	Bank3B IO22 differential Positive. Same pin can be configured Single ended I/O.
88	FPGA_AD7_LVDS3B_7 p	LVDS3B_7p/AD7	IO, 1.8V LVDS	Bank3B IO7 differential Positive. Same pin can be configured Single ended I/O.
89	FPGA_AK3_LVDS3B_2 2n	LVDS3B_22n/AK3	IO, 1.8V LVDS	Bank3B IO22 differential Negative. Same pin can be configured Single ended I/O.
90	FPGA_AC7_LVDS3B_7 n	LVDS3B_7n/AC7	IO, 1.8V LVDS	Bank3B IO7 differential Negative. Same pin can be configured Single ended I/O.
91	FPGA_AJ4_LVDS3B_21 p	LVDS3B_21p/AJ4	IO, 1.8V LVDS	Bank3B IO21 differential Positive. Same pin can be configured Single ended I/O.
92	FPGA_AH3_LVDS3B_1 8p	LVDS3B_18p/AH3	IO, 1.8V LVDS	Bank3B IO18 differential Positive. Same pin can be configured Single ended I/O.
93	FPGA_AH4_LVDS3B_2 1n	LVDS3B_21n/AH4	IO, 1.8V LVDS	Bank3B IO21 differential Negative. Same pin can be configured Single ended I/O.
94	FPGA_AG3_LVDS3B_1 8n	LVDS3B_18n/AG3	IO, 1.8V LVDS	Bank3B IO18 differential Negative. Same pin can be configured Single ended I/O.

Arria10 SoC/FPGA SOM Hardware User Guide

B2B-2 Pin No	B2B Connector2 Pin Name	SoC Ball Name/ Pin Number	Signal Type/ Termination	Description
95	FPGA_AL1_LVDS3B_2 4p	LVDS3B_24p/AL1	IO, 1.8V LVDS	Bank3B IO24 differential Positive. Same pin can be configured Single ended I/O.
96	FPGA_AG2_LVDS3B_1 9n	LVDS3B_19n/AG2	IO, 1.8V LVDS	Bank3B IO19 differential Negative. Same pin can be configured Single ended I/O.
97	FPGA_AK1_LVDS3B_2 4n	LVDS3B_24n/AK1	IO, 1.8V LVDS	Bank3B IO24 differential Negative. Same pin can be configured Single ended I/O.
98	FPGA_AG1_LVDS3B_1 9p	LVDS3B_19p/AG1	IO, 1.8V LVDS	Bank3B IO19 differential Positive. Same pin can be configured Single ended I/O.
99	FPGA_AK2_LVDS3B_2 3p	LVDS3B_23p/AK2	IO, 1.8V LVDS	Bank3B IO23 differential Positive. Same pin can be configured Single ended I/O.
100	FPGA_AE4_LVDS3B_3 p	LVDS3B_3p/AE4	IO, 1.8V LVDS	Bank3B IO3 differential Positive. Same pin can be configured Single ended I/O.
101	FPGA_AJ2_LVDS3B_23 n	LVDS3B_23n/AJ2	IO, 1.8V LVDS	Bank3B IO23 differential Negative. Same pin can be configured Single ended I/O.
102	FPGA_AD4_LVDS3B_3 n	LVDS3B_3n/AD4	IO, 1.8V LVDS	Bank3B IO3 differential Negative. Same pin can be configured Single ended I/O.
103	FPGA_AJ1_LVDS3B_20 p	LVDS3B_20p/AJ1	IO, 1.8V LVDS	Bank3B IO20 differential Positive. Same pin can be configured Single ended I/O.
104	FPGA_AF1_LVDS3B_1 6p	LVDS3B_16p/AF1	IO, 1.8V LVDS	Bank3B IO16 differential Positive. Same pin can be configured Single ended I/O.
105	FPGA_AH2_LVDS3B_2 0n	LVDS3B_20n/AH2	IO, 1.8V LVDS	Bank3B IO20 differential Negative. Same pin can be configured Single ended I/O.
106	FPGA_AE1_LVDS3B_1 6n	LVDS3B_16n/AE1	IO, 1.8V LVDS	Bank3B IO16 differential Negative. Same pin can be configured Single ended I/O.
109	FPGA_AD10_LVDS3B_12p/CLKIN_1p	LVDS3B_12p/AD10	IO, 1.8V LVDS	Bank3B IO12 differential Positive. Same pin can be configured as Clock1 Input differential Positive or Single ended I/O.
110	FPGA_AC8_LVDS3B_10p/CLKOUT_1p	LVDS3B_10p/AC8	IO, 1.8V LVDS	Bank3B IO10 differential Positive. Same pin can be configured as Clock1 Output differential Positive or Single ended I/O.

Arria10 SoC/FPGA SOM Hardware User Guide

B2B-2 Pin No	B2B Connector2 Pin Name	SoC Ball Name/ Pin Number	Signal Type/ Termination	Description
111	FPGA_AD11_LVDS3B_12n/CLKIN_1n	LVDS3B_12n/AD11	IO, 1.8V LVDS	Bank3B IO12 differential Negative. Same pin can be configured as Clock1 Input differential Negative or Single ended I/O.
112	FPGA_AD9_LVDS3B_10n/CLKOUT_1n	LVDS3B_10n/AD9	IO, 1.8V LVDS	Bank3B IO10 differential Negative. Same pin can be configured as Clock1 Output differential Negative or Single ended I/O.
115	FPGA_AF4_LVDS3B_15p/CLKOUT_0p	LVDS3B_15p/AF4	IO, 1.8V LVDS	Bank3B IO15 differential Positive. Same pin can be configured as Clock0 Output differential Positive or Single ended I/O.
116	FPGA_AE2_LVDS3B_13p/CLKIN_0p	LVDS3B_13p/AE2	IO, 1.8V LVDS	Bank3B IO13 differential Positive. Same pin can be configured as Clock0 Input differential Positive or Single ended I/O.
117	FPGA_AF3_LVDS3B_15n/CLKOUT_0n	LVDS3B_15n/AF3	IO, 1.8V LVDS	Bank3B IO15 differential Negative. Same pin can be configured as Clock0 Output differential Negative or Single ended I/O.
118	FPGA_AE3_LVDS3B_13n/CLKIN_0n	LVDS3B_13n/AE3	IO, 1.8V LVDS	Bank3B IO13 differential Negative. Same pin can be configured as Clock0 Input differential Negative or Single ended I/O.
121	FPGA_AB11_LVDS3B_1n	LVDS3B_1n/AB11	IO, 1.8V LVDS	Bank3B IO1 differential Negative. Same pin can be configured Single ended I/O.
122	FPGA_AD2_LVDS3B_2p	LVDS3B_2p/AD2	IO, 1.8V LVDS	Bank3B IO2 differential Positive. Same pin can be configured Single ended I/O.
123	FPGA_AB10_LVDS3B_1p	LVDS3B_1p/AB10	IO, 1.8V LVDS	Bank3B IO1 differential Positive. Same pin can be configured Single ended I/O.
124	FPGA_AD1_LVDS3B_2n	LVDS3B_2n/AD1	IO, 1.8V LVDS	Bank3B IO2 differential Negative. Same pin can be configured Single ended I/O.
125	FPGA_AB5_LVDS3B_5n	LVDS3B_5n/AB5	IO, 1.8V LVDS	Bank3B IO5 differential Negative. Same pin can be configured Single ended I/O.
126	FPGA_AC4_LVDS3B_6p	LVDS3B_6p/AC4	IO, 1.8V LVDS	Bank3B IO6 differential Positive. Same pin can be configured Single ended I/O.

B2B-2 Pin No	B2B Connector2 Pin Name	SoC Ball Name/ Pin Number	Signal Type/ Termination	Description
127	FPGA_AB6_LVDS3B_5 p	LVDS3B_5p/AB6	IO, 1.8V LVDS	Bank3B IO5 differential Positive. Same pin can be configured Single ended I/O.
128	FPGA_AC5_LVDS3B_6 n	LVDS3B_6n/AC5	IO, 1.8V LVDS	Bank3B IO6 differential Negative. Same pin can be configured Single ended I/O.

2.8.2.3 FPGA IOs & General Purpose Clocks – Bank3C

The Arria10 SoC/FPGA SOM supports upto 24 LVDS IO pairs from Arria10 FPGA Bank3C on Board to Board connector2. These Bank3C signals on Board to Board connector2 is routed as LVDS IO pairs in the board. Every LVDS pair can be configured as receiver or transmitter and works upto 1.6 Gbps. If the Single Ended IOs are required in these pins, it may also be configured even though the signals are routed as LVDS IOs.

In Arria10 SoC/FPGA SOM, upon these 24 LVDS IO pairs from Arria10 FPGA Bank3C, two General Purpose Clock input LVDS pairs and two General Purpose Clock Output LVDS pairs are supported on Board to Board connector2. If Single Ended Clock is required instead of LVDS, then the same LVDS clock pins can be configured as General Purpose single ended clock.

The IO voltage of Bank3C is connected from LDO3 output of the PMIC and supports variable IO voltage setting. IO voltage is configurable from 1.2V to 3.3V through software. While using as LVDS IOs or Single Ended IOs, make sure to set the PMIC LDO3 to output appropriate IO voltage for Bank3C. By default, IO voltage of Bank3C is set as 1.8V.

For more details on Bank3C FPGA pinouts on Board to Board Connector2, refer the below table.

B2B-2 Pin No	B2B Connector2 Pin Name	SoC Ball Name/ Pin Number	Signal Type/ Termination	Description
131	FPGA_AB1_LVDS3C_2 4p	LVDS3C_24p/ AB1	IO, 1.8V LVDS	Bank3C IO24 differential Positive. Same pin can be configured Single ended I/O.
132	FPGA_AC3_LVDS3C_2 2p	LVDS3C_22p/ AC3	IO, 1.8V LVDS	Bank3C IO22 differential Positive. Same pin can be configured Single ended I/O.
133	FPGA_AA1_LVDS3C_2 4n	LVDS3C_24n/ AA1	IO, 1.8V LVDS	Bank3C IO24 differential Negative. Same pin can be configured Single ended I/O.
134	FPGA_AC2_LVDS3C_2 2n	LVDS3C_22n/ AC2	IO, 1.8V LVDS	Bank3C IO22 differential Negative. Same pin can be configured Single ended I/O.
135	FPGA_AA3_LVDS3C_2 0p	LVDS3C_20p/ AA3	IO, 1.8V LVDS	Bank3C IO20 differential Positive. Same pin can be configured Single ended I/O
136	FPGA_AB2_LVDS3C_2 1p	LVDS3C_21p/ AB2	IO, 1.8V LVDS	Bank3C IO21 differential Positive. Same pin can be configured Single ended I/O
137	FPGA_AA4_LVDS3C_2 0n	LVDS3C_20n/ AA4	IO, 1.8V LVDS	Bank3C IO20 differential Negative. Same pin can be configured Single ended I/O.
138	FPGA_AB3_LVDS3C_2 1n	LVDS3C_21n/ AB3	IO, 1.8V LVDS	Bank3C IO21 differential Negative. Same pin can be configured Single ended I/O.

Arria10 SoC/FPGA SOM Hardware User Guide

B2B-2 Pin No	B2B Connector2 Pin Name	SoC Ball Name/ Pin Number	Signal Type/ Termination	Description
139	FPGA_Y1_LVDS3C_23p	LVDS3C_23p/ Y1	IO, 1.8V LVDS	Bank3C IO23 differential Positive. Same pin can be configured Single ended I/O
140	FPGA_AA8_LVDS3C_17p	LVDS3C_17p/ AA8	IO, 1.8V LVDS	Bank3C IO17 differential Positive. Same pin can be configured Single ended I/O
141	FPGA_Y2_LVDS3C_23n	LVDS3C_23n/ Y2	IO, 1.8V LVDS	Bank3C IO23 differential Negative. Same pin can be configured Single ended I/O.
142	FPGA_AA9_LVDS3C_17n	LVDS3C_17n/ AA9	IO, 1.8V LVDS	Bank3C IO17 differential Negative. Same pin can be configured Single ended I/O.
143	FPGA_V3_LVDS3C_9n	LVDS3C_9n/ V3	IO, 1.8V LVDS	Bank3C IO9 differential Negative. Same pin can be configured Single ended I/O.
144	FPGA_Y3_LVDS3C_19p	LVDS3C_19p/ Y3	IO, 1.8V LVDS	Bank3C IO19 differential Positive. Same pin can be configured Single ended I/O
145	FPGA_U3_LVDS3C_9p	LVDS3C_9p/ U3	IO, 1.8V LVDS	Bank3C IO9 differential Positive. Same pin can be configured Single ended I/O
146	FPGA_Y4_LVDS3C_19n	LVDS3C_19n/ Y4	IO, 1.8V LVDS	Bank3C IO19 differential Negative. Same pin can be configured Single ended I/O.
147	FPGA_V2_LVDS3C_11p	LVDS3C_11p/ V2	IO, 1.8V LVDS	Bank3C IO11 differential Positive. Same pin can be configured Single ended I/O.
148	FPGA_V5_LVDS3C_6p	LVDS3C_6p/ V5	IO, 1.8V LVDS	Bank3C IO6 differential Positive. Same pin can be configured Single ended I/O.
149	FPGA_U2_LVDS3C_11n	LVDS3C_11n/ U2	IO, 1.8V LVDS	Bank3C IO11 differential Negative. Same pin can be configured Single ended I/O.
150	FPGA_V4_LVDS3C_6n	LVDS3C_6n/ V4	IO, 1.8V LVDS	Bank3C IO6 differential Negative. Same pin can be configured Single ended I/O.
151	FPGA_U6_LVDS3C_5p	LVDS3C_5p/ U6	IO, 1.8V LVDS	Bank3C IO5 differential Positive. Same pin can be configured Single ended I/O
152	FPGA_W6_LVDS3C_16p	LVDS3C_16p/ W6	IO, 1.8V LVDS	Bank3C IO16 differential Positive. Same pin can be configured Single ended I/O

Arria10 SoC/FPGA SOM Hardware User Guide

B2B-2 Pin No	B2B Connector2 Pin Name	SoC Ball Name/ Pin Number	Signal Type/ Termination	Description
153	FPGA_U5_LVDS3C_5n	LVDS3C_5n/ U5	IO, 1.8V LVDS	Bank3C IO5 differential Negative. Same pin can be configured Single ended I/O.
154	FPGA_W7_LVDS3C_16n	LVDS3C_16n/ W7	IO, 1.8V LVDS	Bank3C IO16 differential Negative. Same pin can be configured Single ended I/O.
155	FPGA_T4_LVDS3C_1p	LVDS3C_1p/ T4	IO, 1.8V LVDS	Bank3C IO1 differential Positive. Same pin can be configured Single ended I/O
156	FPGA_Y8_LVDS3C_14p	LVDS3C_14p/ Y8	IO, 1.8V LVDS	Bank3C IO14 differential Positive. Same pin can be configured Single ended I/O
157	FPGA_R4_LVDS3C_1n	LVDS3C_1n/ R4	IO, 1.8V LVDS	Bank3C IO1 differential Negative. Same pin can be configured Single ended I/O.
158	FPGA_Y9_LVDS3C_14n	LVDS3C_14n/ Y9	IO, 1.8V LVDS	Bank3C IO4 differential Negative. Same pin can be configured Single ended I/O.
159	FPGA_R1_LVDS3C_8p	LVDS3C_8p/ R1	IO, 1.8V LVDS	Bank3C IO8 differential Positive. Same pin can be configured Single ended I/O
160	FPGA_R3_LVDS3C_3n	LVDS3C_3n/ R3	IO, 1.8V LVDS	Bank3C IO3 differential Negative. Same pin can be configured Single ended I/O.
161	FPGA_P1_LVDS3C_8n	LVDS3C_8n/ P1	IO, 1.8V LVDS	Bank3C IO8 differential Negative. Same pin can be configured Single ended I/O.
162	FPGA_T3_LVDS3C_3p	LVDS3C_3p/ T3	IO, 1.8V LVDS	Bank3C IO3 differential Positive. Same pin can be configured Single ended I/O
163	FPGA_P2_LVDS3C_7p	LVDS3C_7p/ P2	IO, 1.8V LVDS	Bank3C IO7 differential Positive. Same pin can be configured Single ended I/O
164	FPGA_P4_LVDS3C_2p	LVDS3C_2p/ P4	IO, 1.8V LVDS	Bank3C IO2 differential Positive. Same pin can be configured Single ended I/O
165	FPGA_R2_LVDS3C_7n	LVDS3C_7n/ R2	IO, 1.8V LVDS	Bank3C IO7 differential Negative. Same pin can be configured Single ended I/O.
166	FPGA_P5_LVDS3C_2n	LVDS3C_2n/ P5	IO, 1.8V LVDS	Bank3C IO2 differential Negative. Same pin can be configured Single ended I/O.

Arria10 SoC/FPGA SOM Hardware User Guide

B2B-2 Pin No	B2B Connector2 Pin Name	SoC Ball Name/ Pin Number	Signal Type/ Termination	Description
169	FPGA_U1_LVDS3C_10p/CLKOUT_1p	LVDS3C_10p/U1	IO, 1.8V LVDS	Bank3C IO10 differential Positive. Same pin can be configured as Clock1 Output differential Positive or Single ended I/O.
170	FPGA_W4_LVDS3C_15p/CLKOUT_0p	LVDS3C_15p/W4	IO, 1.8V LVDS	Bank3C IO15 differential Positive. Same pin can be configured as Clock0 Output differential Positive or Single ended I/O
171	FPGA_T1_LVDS3C_10n/CLKOUT_1n	LVDS3C_10n/T1	IO, 1.8V LVDS	Bank3C IO10 differential Negative. Same pin can be configured as Clock1 Output differential Negative or Single ended I/O.
172	FPGA_W5_LVDS3C_15n/CLKOUT_0n	LVDS3C_15n/W5	IO, 1.8V LVDS	Bank3C IO15 differential Negative. Same pin can be configured as Clock0 Output differential Negative or Single ended I/O
175	FPGA_W1_LVDS3C_12p/CLKIN_1p	LVDS3C_12p/W1	IO, 1.8V LVDS	Bank3C IO12 differential Positive. Same pin can be configured as Clock1 Input differential Positive or Single ended I/O
176	FPGA_Y6_LVDS3C_13p/CLKIN_0p	LVDS3C_13p/Y6	IO, 1.8V LVDS	Bank3C IO13 differential Positive. Same pin can be configured as Clock0 Input differential Positive or Single ended I/O
177	FPGA_W2_LVDS3C_12n/CLKIN_1n	LVDS3C_12n/W2	IO, 1.8V LVDS	Bank3C IO12 differential Negative. Same pin can be configured as Clock1 Input differential Negative or Single ended I/O
178	FPGA_Y7_LVDS3C_13n/CLKIN_0n	LVDS3C_13n/Y7	IO, 1.8V LVDS	Bank3C IO13 differential Negative. Same pin can be configured as Clock0 Input differential Negative or Single ended I/O
181	FPGA_T6_LVDS3C_4n	LVDS3C_4n/T6	IO, 1.8V LVDS	Bank3C IO4 differential Negative. Same pin can be configured Single ended I/O.
182	FPGA_AA5_LVDS3C_18p	LVDS3C_18p/AA5	IO, 1.8V LVDS	Bank3C IO18 differential Positive. Same pin can be configured Single ended I/O
183	FPGA_T5_LVDS3C_4p	LVDS3C_4p/T5	IO, 1.8V LVDS	Bank3C IO4 differential Positive. Same pin can be configured Single ended I/O
184	FPGA_AA6_LVDS3C_18n	LVDS3C_18n/AA6	IO, 1.8V LVDS	Bank3C IO18 differential Negative. Same pin can be configured Single ended I/O.

Arria10 SoC/FPGA SOM Hardware User Guide

2.9 Arria10 SoC HPS Pin Multiplexing on Board to Board Connector2

The Arria10 SoC HPS's IO pins have many alternate functions and can be configured to any one of the alternate functions based on the requirement. Also most of the Arria10 HPS's IO pins can be configured as GPIO if required. The below table provides the details of Arria10 HPS pin connections to the Board to Board connector2 with selected pin function highlighted and available alternate functions. This table has been prepared by referring Hard Processor System Pin Information of Arria10 SoC device.

Table 11: Arria10 SoC HPS IOMUX on Board to Board Connector2

Interface/ Function	B2B Connector2 Pin Number	Arria10 SoC HPS Pin Name	HPS Pin Mux Select 15	HPS Pin Mux Select 14	HPS Pin Mux Select 13	HPS Pin Mux Select 12	HPS Pin Mux Select 8	HPS Pin Mux Select 4	HPS Pin Mux Select 3	HPS Pin Mux Select 2	HPS Pin Mux Select 1	HPS Pin Mux Select 0
On-SOM Features from Arria10 HPS												
Micro SD Connector (or) eMMC Flash	NA	HPS_DEDICATED_4	GPIO2_IO0	NAND_ADQ0			SDMMC_DATA0	QSPI_CLK				
	NA	HPS_DEDICATED_5	GPIO2_IO1	NAND_ADQ1			SDMMC_CMD	QSPI_IO0				
	NA	HPS_DEDICATED_6	GPIO2_IO2	NAND_WE_N			SDMMC_CCLK	QSPI_SS0				
	NA	HPS_DEDICATED_7	GPIO2_IO3	NAND_RE_N			SDMMC_DATA1	QSPI_IO1				
	NA	HPS_DEDICATED_8	GPIO2_IO4	NAND_ADQ2			SDMMC_DATA2	QSPI_IO2_WPN				
	NA	HPS_DEDICATED_9	GPIO2_IO5	NAND_ADQ3			SDMMC_DATA3	QSPI_IO3_HOLD				
	NA	HPS_DEDICATED_12	GPIO2_IO8	NAND_RB	UART1_TX		SDMMC_DATA4	CM_PLL_CLK1	SPIM0_MOSI		EMAC1_MDIO	I2C_EMAC1_SDA
	NA	HPS_DEDICATED_13	GPIO2_IO9	NAND_CE_N	UART1_RTS_N		SDMMC_DATA5	CM_PLL_CLK2	SPIM0_MISO		EMAC1_MDC	I2C_EMAC1_SCL
	NA	HPS_DEDICATED_14	GPIO2_IO10	NAND_ADQ4	UART1_CTS_N		SDMMC_DATA6	CM_PLL_CLK3	SPIM0_SS0_N		EMAC2_MDIO	I2C_EMAC2_SDA
NA	HPS_DEDICATED_15	GPIO2_IO11	NAND_ADQ5	UART1_RX		SDMMC_DATA7	CM_PLL_CLK4		SPIS0_CLK	EMAC2_MDC	I2C_EMAC2_SCL	
GPIOs	NA	HPS_DIRECT_SHARED_Q1_4	GPIO0_IO3	NAND_RE_N	UART0_RX		USB0_DATA0	SDMMC_DATA1		SPIS0_MISO		I2C1_SCL
	NA	HPS_DIRECT_SHARED_Q1_3	GPIO0_IO2	NAND_WE_N	UART0_TX		USB0_DIR	SDMMC_CCLK		SPIS0_SS0_N		I2C1_SDA

Arria10 SoC/FPGA SOM Hardware User Guide

Interface/ Function	B2B Connector2 Pin Number	Arria10 SoC HPS Pin Name	HPS Pin Mux Select 15	HPS Pin Mux Select 14	HPS Pin Mux Select 13	HPS Pin Mux Select 12	HPS Pin Mux Select 8	HPS Pin Mux Select 4	HPS Pin Mux Select 3	HPS Pin Mux Select 2	HPS Pin Mux Select 1	HPS Pin Mux Select 0
EMAC1	NA	HPS_DIRECT_SHARED_Q3_12	GPIO1_IO11	NAND_ADQ7			EMAC1_RXD3			SPIS0_MISO	EMAC0_MDC	I2C_EMAC0_SCL
	NA	HPS_DIRECT_SHARED_Q3_11	GPIO1_IO10	NAND_ADQ6			EMAC1_RXD2			SPIS0_SS0_N	EMAC0_MDIO	I2C_EMAC0_SDA
	NA	HPS_DIRECT_SHARED_Q3_10	GPIO1_IO9	NAND_ADQ5			EMAC1_TXD3			SPIS0_MOSI	EMAC2_MDC	I2C_EMAC2_SCL
	NA	HPS_DIRECT_SHARED_Q3_9	GPIO1_IO8	NAND_ADQ4			EMAC1_TXD2			SPIS0_CLK	EMAC2_MDIO	I2C_EMAC2_SDA
	NA	HPS_DIRECT_SHARED_Q3_8	GPIO1_IO7	NAND_CLE	UART1_RX		EMAC1_RXD1			SPIS1_MISO		I2C1_SCL
	NA	HPS_DIRECT_SHARED_Q3_7	GPIO1_IO6	NAND_ADQ3	UART1_TX		EMAC1_RXD0			SPIS1_SS0_N		I2C1_SDA
	NA	HPS_DIRECT_SHARED_Q3_6	GPIO1_IO5	NAND_ADQ2	UART1_RTS_N		EMAC1_TXD1			SPIS1_MOSI		
	NA	HPS_DIRECT_SHARED_Q3_5	GPIO1_IO4	NAND_WP_N	UART1_CTS_N		EMAC1_TXD0		SPIM1_SS1_N	SPIS1_CLK		
	NA	HPS_DIRECT_SHARED_Q3_4	GPIO1_IO3	NAND_RE_N	UART0_RX		EMAC1_RX_CTL		SPIM1_SS0_N			I2C0_SCL
	NA	HPS_DIRECT_SHARED_Q3_3	GPIO1_IO2	NAND_WE_N	UART0_TX		EMAC1_RX_CLK		SPIM1_MISO			I2C0_SDA
	NA	HPS_DIRECT_SHARED_Q3_2	GPIO1_IO1	NAND_ADQ1	UART0_RTS_N		EMAC1_TX_CTL		SPIM1_MOSI			
	NA	HPS_DIRECT_SHARED_Q3_1	GPIO1_IO0	NAND_ADQ0	UART0_CTS_N		EMAC1_TX_CLK		SPIM1_CLK			
	NA	HPS_DIRECT_SHARED_Q1_10	GPIO0_IO9	NAND_ADQ5			USB0_DATA5	SDMMC_DATA7	SPIM1_MOSI	SPIS1_MOSI	EMAC1_MDC	I2C_EMAC1_SCL
	NA	HPS_DIRECT_SHARED_Q1_9	GPIO0_IO8	NAND_ADQ4			USB0_DATA4	SDMMC_DATA6	SPIM1_CLK	SPIS1_CLK	EMAC1_MDIO	I2C_EMAC1_SDA
USB1	NA	HPS_DIRECT_SHARED_Q2_12	GPIO0_IO23	NAND_ADQ15	UART0_RX		USB1_DATA7	EMAC0_RXD3	SPIM1_SS0_N	SPIS0_MISO		I2C0_SCL
	NA	HPS_DIRECT_SHARED_Q2_11	GPIO0_IO22	NAND_ADQ14	UART0_TX		USB1_DATA6	EMAC0_RXD2	SPIM1_MISO	SPIS0_SS0_N		I2C0_SDA
	NA	HPS_DIRECT_SHARED_Q2_10	GPIO0_IO21	NAND_ADQ13	UART0_RTS_N		USB1_DATA5	EMAC0_TXD3	SPIM1_MOSI	SPIS0_MOSI		I2C1_SCL
	NA	HPS_DIRECT_SHARED_Q2_9	GPIO0_IO20	NAND_ADQ12	UART0_CTS_N		USB1_DATA4	EMAC0_TXD2	SPIM1_CLK	SPIS0_CLK		I2C1_SDA
	NA	HPS_DIRECT_SHARED_Q2_8	GPIO0_IO19	NAND_ADQ11			USB1_DATA3	EMAC0_RXD1	SPIM1_SS1_N			
	NA	HPS_DIRECT_SHARED_Q2_7	GPIO0_IO18	NAND_ADQ10			USB1_DATA2	EMAC0_RXD0				
	NA	HPS_DIRECT_SHARED_Q2_6	GPIO0_IO17	NAND_ADQ9			USB1_NXT	EMAC0_TXD1				
	NA	HPS_DIRECT_SHARED_Q2_5	GPIO0_IO16	NAND_ADQ8			USB1_DATA1	EMAC0_TXD0				
	NA	HPS_DIRECT_SHARED_Q2_4	GPIO0_IO15				USB1_DATA0	EMAC0_RX_CTL				
	NA	HPS_DIRECT_SHARED_Q2_3	GPIO0_IO14	NAND_CE_N			USB1_DIR	EMAC0_RX_CLK				
	NA	HPS_DIRECT_SHARED_Q2_2	GPIO0_IO13	NAND_RB			USB1_STP	EMAC0_TX_CTL				
NA	HPS_DIRECT_SHARED_Q2_1	GPIO0_IO12	NAND_ALE			USB1_CLK	EMAC0_TX_CLK					

Arria10 SoC/FPGA SOM Hardware User Guide

Interface/ Function	B2B Connector2 Pin Number	Arria10 SoC HPS Pin Name	HPS Pin Mux Select 15	HPS Pin Mux Select 14	HPS Pin Mux Select 13	HPS Pin Mux Select 12	HPS Pin Mux Select 8	HPS Pin Mux Select 4	HPS Pin Mux Select 3	HPS Pin Mux Select 2	HPS Pin Mux Select 1	HPS Pin Mux Select 0
Board to Board Connector2 Interfaces from Arria10 HPS												
GPIOs	68	HPS_DIRECT_SHARED_Q1_1	GPIO0_IO0	NAND_ADQ0	UART0_CTS_N		USB0_CLK	SDMMC_DATA0	SPIM0_SS1_N	SPIS0_CLK		
	70	HPS_DIRECT_SHARED_Q1_2	GPIO0_IO1	NAND_ADQ1	UART0_RTS_N		USB0_STP	SDMMC_CMD	SPIM1_SS1_N	SPIS0_MOSI		
	38	HPS_DIRECT_SHARED_Q1_11	GPIO0_IO10	NAND_ADQ6			USB0_DATA6		SPIM1_MISO	SPIS1_SS0_N	EMAC0_MDIO	I2C_EMAC0_SDA
	44	HPS_DIRECT_SHARED_Q1_12	GPIO0_IO11	NAND_ADQ7			USB0_DATA7		SPIM1_SS0_N	SPIS1_MISO	EMAC0_MDC	I2C_EMAC0_SCL
	52	HPS_DIRECT_SHARED_Q1_8	GPIO0_IO7	NAND_CLE	UART1_RX		USB0_DATA3	SDMMC_DATA5	SPIM0_SS0_N		EMAC2_MDC	I2C_EMAC2_SCL
	50	HPS_DIRECT_SHARED_Q1_7	GPIO0_IO6	NAND_ADQ3	UART1_TX		USB0_DATA2	SDMMC_DATA4	SPIM0_MISO		EMAC2_MDIO	I2C_EMAC2_SDA
	72	HPS_DIRECT_SHARED_Q4_3	GPIO1_IO14	NAND_CE_N	UART1_TX		EMAC2_RX_CLK	SDMMC_CCLK				
	66	HPS_DIRECT_SHARED_Q4_4	GPIO1_IO15		UART1_RX	Trace_CLK	EMAC2_RX_CTL	SDMMC_DATA1				
	64	HPS_DIRECT_SHARED_Q4_5	GPIO1_IO16	NAND_ADQ8	UART1_CTS_N	QSPI_SS2	EMAC2_TXD0	SDMMC_DATA2				
	62	HPS_DIRECT_SHARED_Q4_6	GPIO1_IO17	NAND_ADQ9	UART1_RTS_N	QSPI_SS3	EMAC2_TXD1	SDMMC_DATA3	SPIM0_SS1_N			
	42	HPS_DIRECT_SHARED_Q4_7	GPIO1_IO18	NAND_ADQ10			EMAC2_RXD0	SDMMC_DATA4	SPIM0_MISO		EMAC1_MDIO	I2C_EMAC1_SDA
	40	HPS_DIRECT_SHARED_Q4_8	GPIO1_IO19	NAND_ADQ11		Trace_CLK	EMAC2_RXD1	SDMMC_DATA5	SPIM0_SS0_N		EMAC1_MDC	I2C_EMAC1_SCL
	71	HPS_DIRECT_SHARED_Q4_2	GPIO1_IO13	NAND_RB			EMAC2_TX_CTL	SDMMC_CMD				I2C1_SCL
69	HPS_DIRECT_SHARED_Q4_1	GPIO1_IO12	NAND_ALE			EMAC2_TX_CLK	SDMMC_DATA0				I2C1_SDA	
SPI	63	HPS_DIRECT_SHARED_Q4_12	GPIO1_IO23	NAND_ADQ15		Trace_D3	EMAC2_RXD3		SPIM0_SS0_N	SPIS1_MISO	EMAC0_MDC	I2C_EMAC0_SCL
	67	HPS_DIRECT_SHARED_Q4_11	GPIO1_IO22	NAND_ADQ14		Trace_D2	EMAC2_RXD2		SPIM0_MISO	SPIS1_SS0_N	EMAC0_MDIO	I2C_EMAC0_SDA
	65	HPS_DIRECT_SHARED_Q4_10	GPIO1_IO21	NAND_ADQ13		Trace_D1	EMAC2_TXD3	SDMMC_DATA7	SPIM0_MOSI	SPIS1_MOSI		I2C_EMAC2_SCL
	61	HPS_DIRECT_SHARED_Q4_9	GPIO1_IO20	NAND_ADQ12		Trace_D0	EMAC2_TXD2	SDMMC_DATA6	SPIM0_CLK	SPIS1_CLK		I2C_EMAC2_SDA
Dedicated UART1	54	HPS_DEDICATED_16	GPIO2_IO12	NAND_ADQ6	UART1_TX		QSPI_SS2			SPIS0_MOSI	EMAC0_MDIO	I2C_EMAC0_SDA
	56	HPS_DEDICATED_17	GPIO2_IO13	NAND_ADQ7	UART1_RX		QSPI_SS3			SPIS0_SS0_N	EMAC0_MDC	I2C_EMAC0_SCL
I2C	48	HPS_DIRECT_SHARED_Q1_6	GPIO0_IO5	NAND_ADQ2	UART1_RTS_N	QSPI_SS3	USB0_NXT	SDMMC_DATA3	SPIM0_MOSI			I2C0_SCL
	46	HPS_DIRECT_SHARED_Q1_5	GPIO0_IO4	NAND_WP_N	UART1_CTS_N	QSPI_SS2	USB0_DATA1	SDMMC_DATA2	SPIM0_CLK			I2C0_SDA

3. TECHNICAL SPECIFICATION

This section provides detailed information about the Arria10 SoC/FPGA SOM technical specification with Electrical, Environmental and Mechanical characteristics.

3.1 Electrical Characteristics

3.1.1 Power Input Requirement

The below table provides the Power Input Requirement of Arria10 SoC/FPGA SOM.

Table 12: Power Input Requirement

Sl. No.	Power Rail	Min (V)	Typical (V)	Max(V)	Max Input Ripple
1	VCC ¹	4.75V	5V	5.25V	±50mV

¹ The Arria10 SoC/FPGA SOM is designed to work with VCC input power rail from Board to Board connector2.

3.1.2 Power Input Sequencing

The Arria10 SoC/FPGA SOM Power Input sequence requirement is explained below.

Power up Sequence:

- SOMPWR_EN signal from Board to Board Connector1 must be high at the same time or after VCC_5V comes up.

Power down Sequence:

- SOMPWR_EN signal from Board to Board Connector1 must be low at the same time or before VCC_5V goes down.

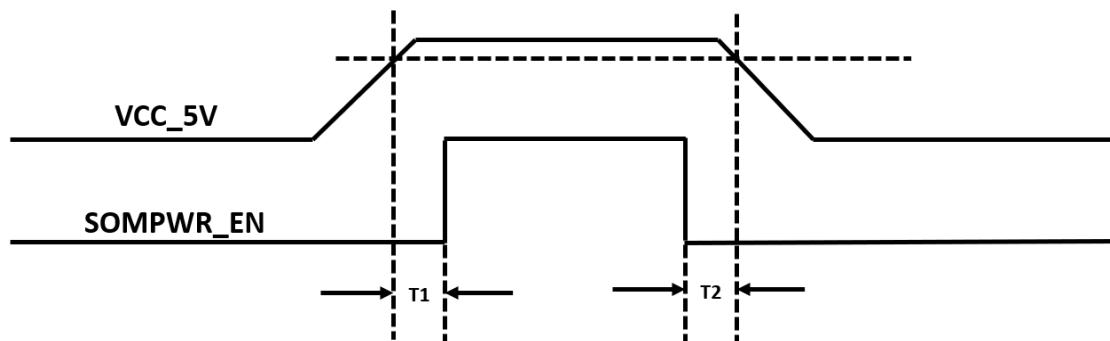

Figure 10: Power Input Sequencing

Table 13: Power Sequence Timing

Item	Description	Value
T1	VCC_5V rise time to SOMPWR_EN rise time	≥ 0 ms
T2	SOMPWR_EN fall time to VCC_5V fall time	≥ 0 ms

3.1.3 Power Consumption

Table 14: Power Consumption

Task/Status	Power Rail	Current Drawn/Power Consumption
Run Mode Power Consumption		
Ethernet 1000Mbps ping	VCC	3.101A/15.13W
Dhrystone benchmark application	VCC	3.233A/15.77W
USB2.0 Host to Micro SD files transfer.	VCC	3.209A/15.65W
HPS DDR4 Read and Write	VCC	3.408A/16.63W
Typical Maximum Power: <ul style="list-style-type: none"> • Ethernet 1000Mbps ping. • Dhrystone benchmark application • USB2.0 Host to Micro SD files transfer 	VCC	3.440A/16.78W

Power consumption measurements have been done in iWave's Arria10 SX480 SOM (iW-G24M-CU2F-4E002G-E008G-LEY) with only HPS enabled.

3.2 Environmental Characteristics

3.2.1 Environmental Specification

The below table provides the Environment specification of Arria10 SoC/FPGA SOM.

Table 15: Environmental Specification

Parameters	Min	Max
Operating temperature range - Industrial ^{1,2}	-40°C	85°C
Operating temperature range - Extended ^{1,2}	0°C	85°C

¹ iWave guarantees the component selection for the given operating temperature. The operating temperature at the system level will be affected by the various system components like carrier board and its components, system enclosure, air circulation in the system, system power supply etc. Based on the system design, specific heat dissipating approach might be required from system to system. It is recommended to do the necessary system level thermal simulation and find necessary thermal solution in the system before using this board in the end application.

²For more information on Thermal solution & Heat spreader refer the following section.

3.2.1 RoHS2 Compliance

iWave's Arria10 SoC/FPGA SOM is designed by using RoHS2 compliant components and manufactured on lead free production process.

3.2.2 Electrostatic Discharge

iWave's Arria10 SoC/FPGA SOM is sensitive to electro static discharge and so high voltages caused by static electricity could damage some of the devices on board. It is packed with necessary protection while shipping. Do not open or use the SOM except at an electrostatic free workstation.

3.2.3 Heat Sink

For any highly integrated System On Modules, thermal design is very important factor. As IC's size is decreasing and performance of module is increasing by rising processor frequencies, it generates high amount of heat which should be dissipated for the system to work as expected without fault.

To dissipate the heat, appropriate thermal management technique like Heat spreader, Heat sink must be used. Always remember that, if you use more effective thermal solution, you will get more performance out of the SoC/FPGA.

iWave supports Heat Sink Solution for Arria10 SoC/FPGA SOM. Please refer the below figure for Heat Sink dimension details. For Heat Sink ordering information, refer section 4 **ORDERING INFORMATION**.

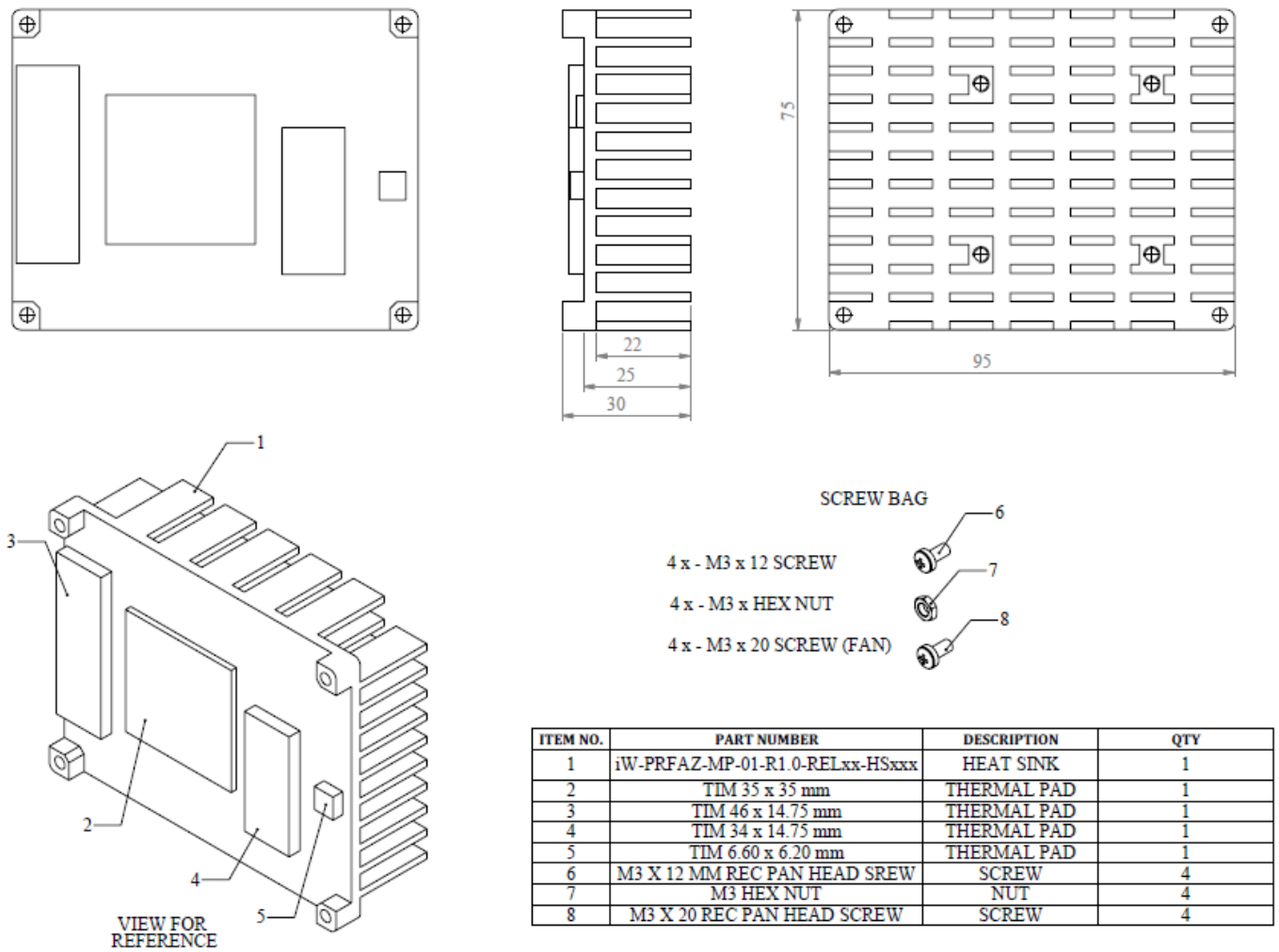

Figure 11: Heat Sink Dimensions

Note: In high Shock/Vibration environment, it is recommended to use thread-locking fluid on Heat spreader screws.

3.3 Mechanical Characteristics

3.3.1 Arria10 SoC/FPGA SOM Mechanical Dimensions

The Arria10 SoC/FPGA SOM PCB size is 95mm x 75mm x 1.5mm. Its mechanical dimension is shown below.

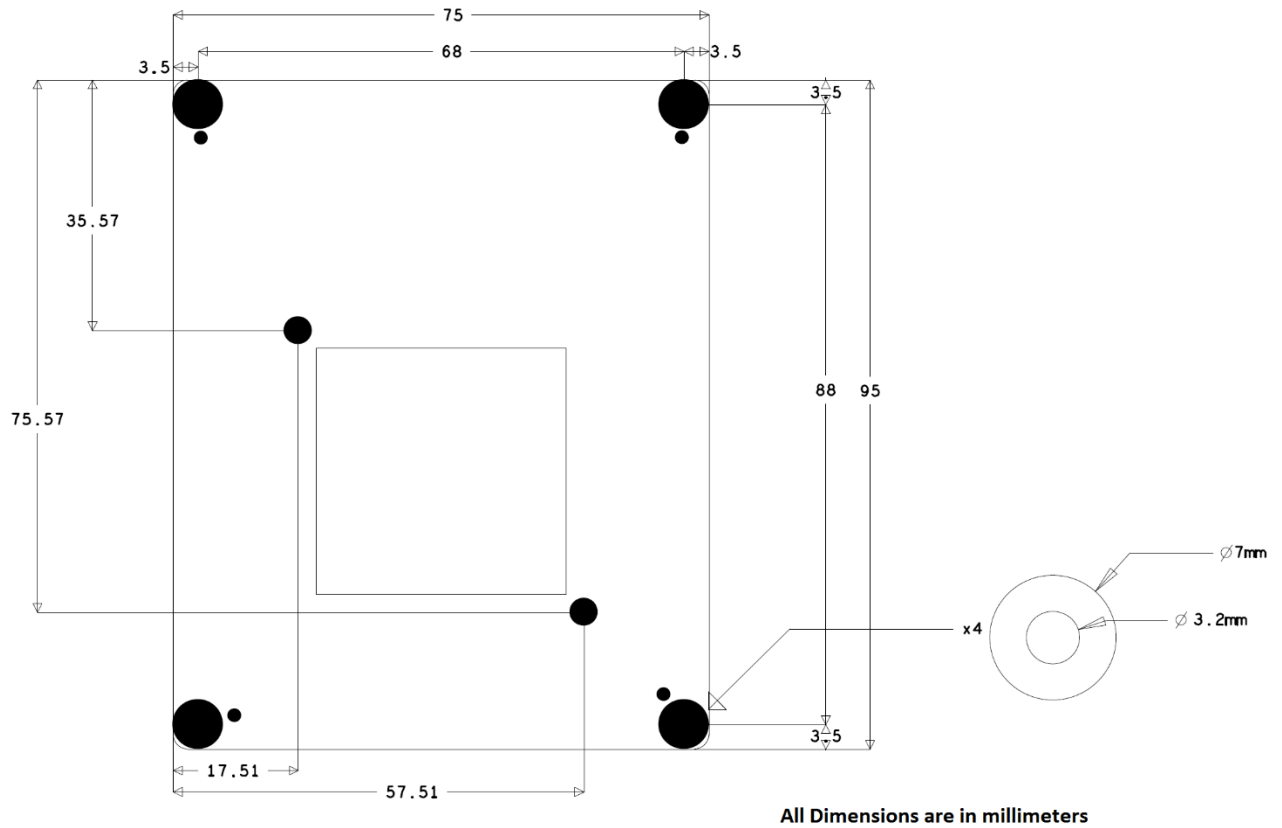

Figure 12: Mechanical dimension of Arria10 SoC/FPGA SOM- Top View

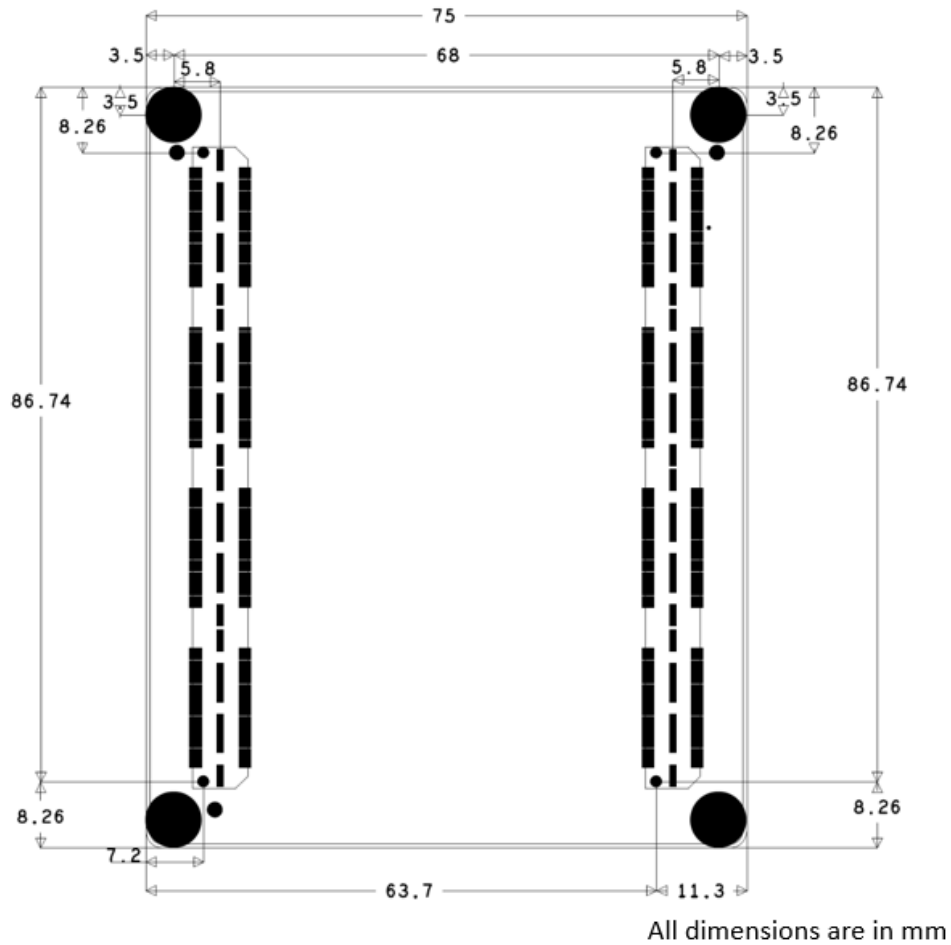

Figure 13: Mechanical dimension of Arria10 SoC/FPGA SOM- Bottom View

Arria10 SoC/FPGA SOM PCB thickness is $1.5\text{mm} \pm 0.10\text{mm}$, top side maximum height component is Inductor (4.00mm) followed by FAN Header (3.5mm) and bottom side maximum height component is Board to Board connector (4.27mm). For more details, refer the below figure which gives height details of Arria10 SoC/FPGA SOM.

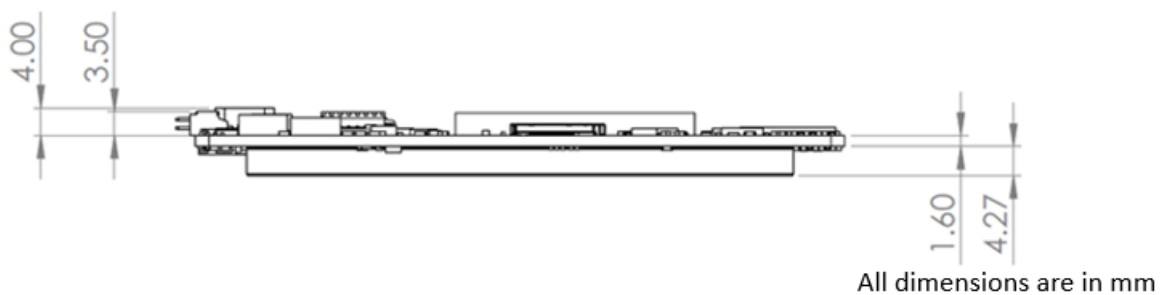

Figure 14: Mechanical dimension of Arria10 SoC/FPGA SOM- Side View

3.3.2 Guidelines to insert the Arria10 SoC/FPGA SOM into Carrier board

- Make sure to use anti-static work environment and wear the anti-static wristband while handling the boards.
- Make sure that the carrier board is completely powered off.
- Insert the Arria10 SoC/FPGA SOM in to the Board to Board connectors as shown below in first photo.
- Check the position of Board to Board connector 1 and Board to Board connector 2 of Arria10 SoC/FPGA SOM is proper while inserting.
- Once the Arria10 SoC/FPGA SOM is inserted to the Board to Board connector 1 and Board to Board connector 2 properly, press the board vertically down such that the board is fixed firmly into the Board to Board connectors as shown below in second photo.

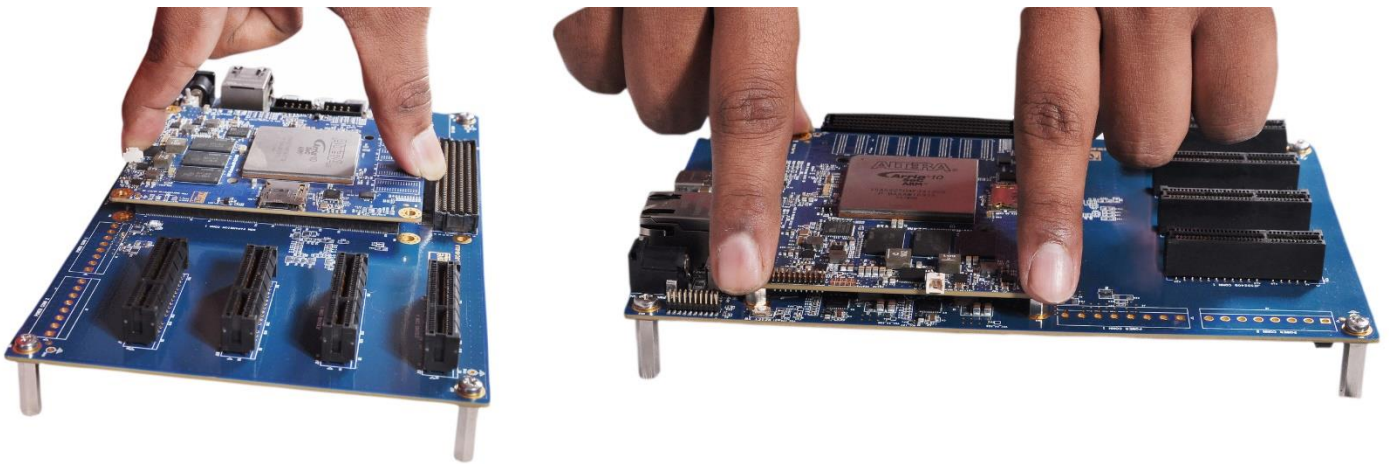

Figure 15: Arria10 SoC/FPGA SOM Insertion procedure

4. ORDERING INFORMATION

The below table provides the standard orderable part numbers for different Arria10 SoC/FPGA SOM variations. Please contact iWave if the desired part number is not listed in below table or if any custom configuration part number is required.

Table 16: Orderable Product Part Numbers

Product Part Number	Description	Temperature
Arria10 SoC/FPGA SOM		
iW-G24M-CU2F-4E002G-S000G-LEU	Arria 10 SX480 (-2FPGA/H3 XCVR) SOC, 2GB HPS DDR4 with ECC, 4GB FPGA DDR4 - Linux	Extended
iW-G24M-CU2F-4E002G-S000G-BEU	Arria 10 SX480 (-2FPGA/H3 XCVR) SOC, 2GB HPS DDR4 with ECC, 4GB FPGA DDR4 - boot code	Extended
iW-G24M-CU2F-4E002G-S000G-LIV	Arria 10 SX660 (-1FPGA/H2 XCVR) SOC, 2GB HPS DDR4 with ECC, 4GB FPGA DDR4 - Linux	Industrial
iW-G24M-CU2F-4E002G-S000G-BIV	Arria 10 SX660 (-1FPGA/H2 XCVR) SOC, 2GB HPS DDR4 with ECC, 4GB FPGA DDR4 - boot code	Industrial
iW-G24M-CU2F-4E001G-S000G-LIW	Arria 10 SX270 (-3-3FPGA/H4 XCVR) SOC, 1GB HPS DDR4 with ECC with Linux	Industrial
iW-G24M-CU2F-4E001G-S000G-BIW	Arria 10 SX270 (-3-3FPGA/H4 XCVR) SOC, 1GB HPS DDR4 with ECC with boot code	Industrial
iW-G24M-CU2F-4E002G-S000G-LEX	Arria 10 SX480 (-2FPGA/H2 SCVR) SOC, 2GB HPS DDR4 with ECC, 4GB FPGA DDR4 (for FMC+ Kit Arrow/ADI) - Linux	Extended
iW-G24M-CU2F-4E002G-S000G-BEX	Arria 10 SX480 (-2FPGA/H2 SCVR) SOC, 2GB HPS DDR4 with ECC, 4GB FPGA DDR4 (for FMC+ Kit Arrow/ADI) - boot code	Extended
Heat Sink		
iW-HSKALU-CLASLR-CU01	Heat Sink for Arria10 SoC/FPGA SOM	-

Important Note: Please contact iWave for orderable part number of higher density Arria10 SoC/FPGA, higher speed grade Arria10 SoC/FPGA or higher RAM memory size supported SOMs.

Note: For SOM identification purpose, Product Part Number and SOM Unique Serial Number are pasted as Label with Barcode readable format on SOM.

5. APPENDIX I

5.1 Arria10 SoC/FPGA SOM Development Platform

iWave Systems supports iW-RainboW-G24D – Arria10 SoC/FPGA SOM Development Platform which is targeted for quick validation of Arria10 SoC/FPGA based SOM and its features. The carrier board is packed with necessary interfaces & on-board connectors to validate Arria10 SoC/FPGA features.

For more details on Arria10 SoC/FPGA SOM Development Platform, visit the below web link.

<http://www.iwavesystems.com/product/cpu-modules/arrisa-10-soc-system-on-module/altera-arrisa-10-soc-som-module.html>

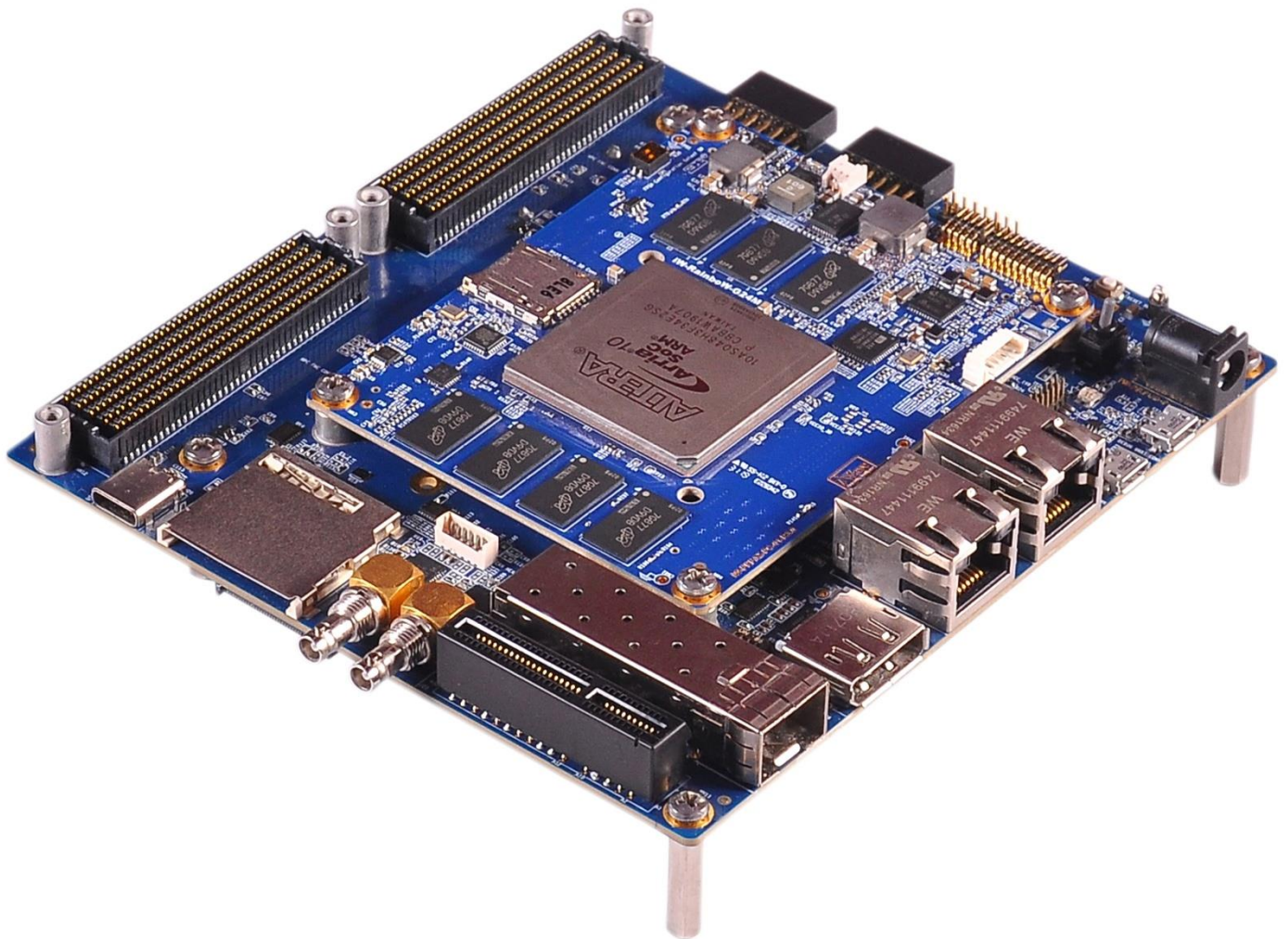

Figure 16: Arria10 SoC/FPGA SOM Development Platform

