

iW-RainboW-G35D

Zynq Ultrascale+ MPSoC (ZU11/17/19EG) SOM Development Platform Hardware User Guide

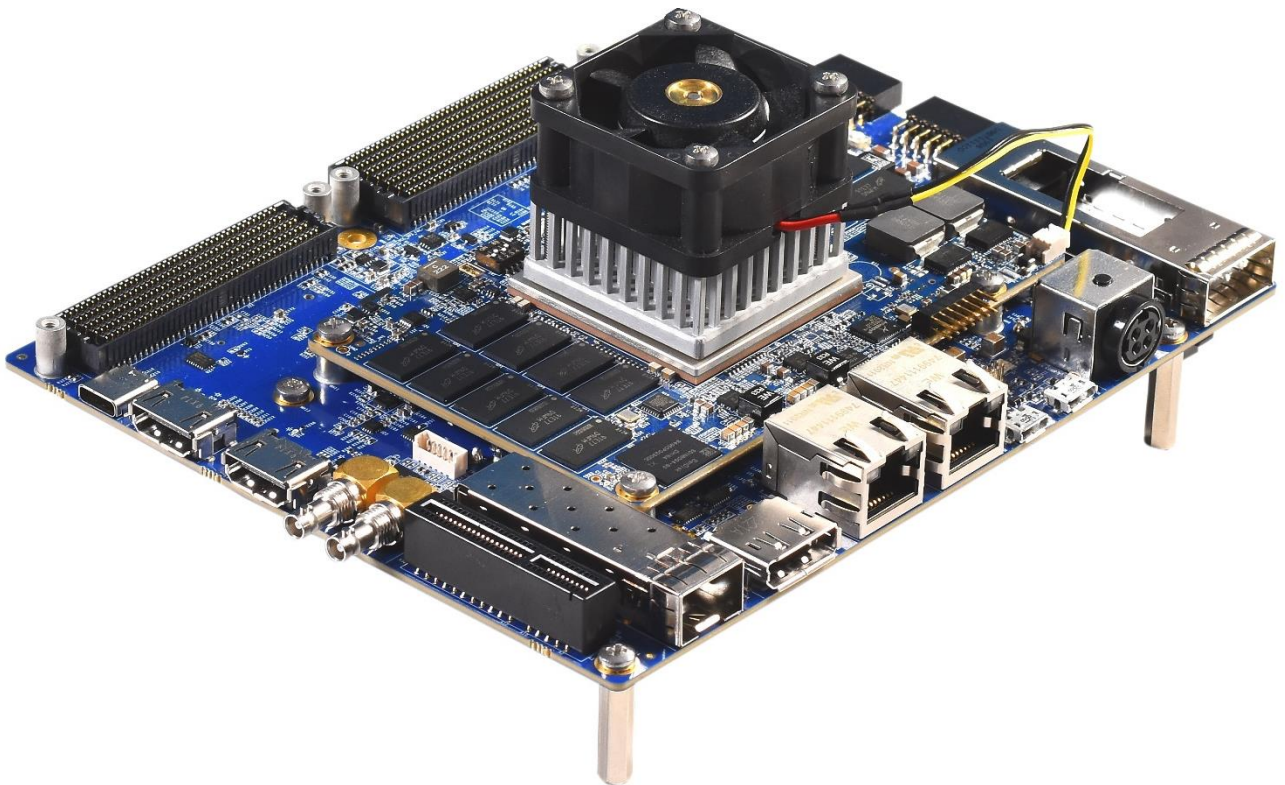

iWave
Embedding Intelligence

Document Revision History

Document Number		iW-PRGED-UM-01-R3.0-REL0.4-Hardware-ZynqMPSoC(ZU11/17/19EG)-UHS-DevKit
Revision	Date	Change Description
0.1	11 th May 2021	Initial Draft Version
0.2	17 th August 2021	Updated Version
0.3	22 th Sep 2021	Updated Version
0.4	09 th May 2022	<ul style="list-style-type: none"> Updated PL IOs“2.5.5 and 2.5.6” Section Signal Termination Type with Note description Updated Table 1: Clock Synthesizer 1 Output Clock Frequency

PROPRIETARY NOTICE: This document contains proprietary material for the sole use of the intended recipient(s). Do not read this document if you are not the intended recipient. Any review, use, distribution or disclosure by others is strictly prohibited. If you are not the intended recipient (or authorized to receive for the recipient), you are hereby notified that any disclosure, copying distribution or use of any of the information contained within this document is STRICTLY PROHIBITED. Thank you. “iWave Systems Tech. Pvt. Ltd.”

Disclaimer

iWave Systems reserves the right to change details in this publication including but not limited to any Product specification without notice.

No warranty of accuracy is given concerning the contents of the information contained in this publication. To the extent permitted by law no liability (including liability to any person by reason of negligence) will be accepted by iWave Systems, its subsidiaries or employees for any direct or indirect loss or damage caused by omissions from or inaccuracies in this document.

CPU and other major components used in this product may have several silicon errata associated with it. Under no circumstances, iWave Systems shall be liable for the silicon errata and associated issues.

Trademarks

All registered trademarks, product names mentioned in this publication are the property of their respective owners and used for identification purposes only.

Certification

iWave Systems Technologies Pvt. Ltd. is an ISO 9001:2015 Certified Company.



Warranty & RMA

Warranty support for Hardware: 1 Year from iWave or iWave's EMS partner.

For warranty terms, go through the below web link,

<http://www.iwavesystems.com/support/warranty.html>

For Return Merchandise Authorization (RMA), go through the below web link,

<http://www.iwavesystems.com/support/rma.html>

Technical Support

iWave Systems technical support team is committed to provide the best possible support for our customers so that our Hardware and Software can be easily migrated and used.

For assistance, contact our Technical Support team at,

Email : support.ip@iwavesystems.com
Website : www.iwavesystems.com
Address : iWave Systems Technologies Pvt. Ltd.
7/B, 29th Main, BTM Layout 2nd Stage,
Bangalore, Karnataka,
India – 560076

Table of Contents

1.	INTRODUCTION.....	8
1.1	Purpose	8
1.2	Overview	8
1.3	List of Acronyms	8
1.4	References.....	10
2.	ARCHITECTURE AND DESIGN	11
2.1	Zynq Ultrascale+ MPSoC (ZU11/17/19EG) SOM Carrier Board Block Diagram.....	11
2.2	Zynq Ultrascale+ MPSoC (ZU11/17/19EG) SOM Carrier Board Features	12
2.3	Board to Board Connectors.....	14
2.3.1	Board to Board Connector1	14
2.3.2	Board to Board Connector2	15
2.3.3	Board to Board Connector3	16
2.3.4	Board to Board Connector4	17
2.4	PS Interface Features.....	18
2.4.1	PS-GTR Transceivers	18
2.4.2	Gigabit Ethernet Port1	30
2.4.3	Gigabit Ethernet Port2	31
2.4.4	USB2.0 OTG Port.....	32
2.4.5	Standard SD Port	33
2.4.6	CAN0 Header	35
2.4.7	Debug UART	36
2.5	PL Interface Features	37
2.5.1	GTH High Speed Transceivers.....	37
2.5.2	GTY High Speed Transceivers	44
2.5.3	Pmod Host Port Connectors	50
2.5.4	FMC HPC Connector.....	53
2.5.5	FMC+ HPC Connector.....	68
2.6	Additional Features	89
2.6.1	Clock Synthesizers.....	89
2.6.2	JTAG Connector	92
2.6.3	IO Expanders.....	94
2.6.4	I2C Expander.....	97
2.6.5	GPIO Header.....	98
2.6.6	Power ON/OFF Switch.....	100
2.6.7	Reset Switch	101
2.6.8	RTC Coin Cell Holder	102
2.6.9	12V Fan Header	103
3.	TECHNICAL SPECIFICATION.....	104
3.1	Power Input Requirement.....	104
3.2	Power Output Specification	105

3.3	Environmental Characteristics	106
3.3.1	Environmental Specification.....	106
3.3.2	RoHS Compliance.....	106
3.3.3	Electrostatic Discharge.....	106
3.4	Mechanical Characteristics	107
3.4.1	Carrier Board Mechanical Dimensions.....	107
3.4.2	Guidelines to insert the Zynq Ultrascale+ SoC SOM into Carrier Board	109
3.4.3	FAN Sink Fixing procedure on SOM with Carrier Board.....	110
4.	ORDERING INFORMATION.....	111

List of Figures

Figure 1: Zynq Ultrascale+ MPSoC (ZU11/17/19EG) SOM Carrier Board Block Diagram.....	11
Figure 2: Board to Board Connector1	14
Figure 3: Board to Board Connector2	15
Figure 4 Board to Board Connector3	16
Figure 5 Board to Board Connector4	17
Figure 6: PS-GTR External Switch Connectivity.....	18
Figure 7: PS-GTR Lane Selection Switch	19
Figure 8: PCIe x4 Connector	20
Figure 9: Display Port Connector	23
Figure 10: USB Type-C Connector	25
Figure 11: M.2 SATA Connector (Key M).....	27
Figure 12: Gigabit Ethernet Connector1	30
Figure 13: Gigabit Ethernet Connector2	31
Figure 14: USB OTG Connector.....	33
Figure 15: Standard SD Connector.....	34
Figure 16: CAN0 Header.....	35
Figure 17: Debug UART Connector	36
Figure 18: SFP+ Connector with Cage	38
Figure 19: SDI Video IN HD BNC Connector	40
Figure 20: SDI Video OUT HD BNC Connector	41
Figure 21 HDMI IN Connector	42
Figure 22 HDMI OUT Connector	43
Figure 23 QSFP28/QSFP+/QSFP+ Connector with Cage.....	44
Figure 24 FireFly Connector	47
Figure 25: Pmod Host Port Connectors.....	50
Figure 26: SMA Connectors	52
Figure 27: FMC Connector.....	53
Figure 28: FMC HPC Connector Pin Out	54
Figure 29: FMC+ Connector.....	68
Figure 30: FMC+ HPC Connector Pin Out	69
Figure 31: Clock Tree.....	91
Figure 32: JTAG Connector	92
Figure 33 I2C Tree	97
Figure 34: GPIO Header.....	98
Figure 35: Power On/Off Switch	100
Figure 36: Reset Switch	101
Figure 37: RTC Coin Cell Holder	102
Figure 38: 12V-Fan Header.....	103
Figure 39: Power Jack.....	104
Figure 40: Carrier board Mechanical dimension – Top View	107
Figure 41: Carrier board Mechanical dimension – Side View.....	108
Figure 42: Zynq Ultrascale+ SoC SOM Inserting Procedure	109
Figure 43: Zynq Ultrascale+ SOM with Fan sink fixing procedure	110

List of Tables

Table 1: Acronyms & Abbreviations.....	8
Table 2: Terminology	10
Table 3: PS-GTR Lane Selection Switch Setting	19
Table 4: PCIe x4 Connector Pin Assignment.....	21
Table 5: USB TypeC Pin Assignment.....	26
Table 6: M.2 SATA Connector Pin Assignment	28
Table 7: CAN0 Header Pin Assignment	35
Table 8: SFP+ Connector Pin Assignment.....	39
Table 9 QSFP28/QSFP+/QSFP Connector Pin Out.....	45
Table 10 FireFly Data Connector Pin Out	48
Table 11 FireFly Power Connector Pin Out	49
Table 12: Pmod Connector1 Pin Assignment	51
Table 13: Pmod Connector2 Pin Assignment	51
Table 14: SMA Connector Pin Assignment.....	52
Table 15: FMC HPC Connector Pin Assignment.....	55
Table 16: FMC+ HPC Connector Pin Assignment	70
Table 17: Clock Synthesizer 1 Output Clocks.....	89
Table 18 Clock Synthesizer 2 Output Clocks.....	90
Table 19: JTAG Header Pin Assignment	93
Table 20 IO EXPANDER 1 Output	94
Table 21 IO EXPANDER 2 Output	95
Table 22 IO EXPANDER 3 Output	96
Table 23: GPIO Header Pin Assignment	98
Table 24: 12V Fan Header Pinout	103
Table 25: Power Input Requirement.....	104
Table 26: Power Output Specification	105
Table 27: Environmental Specification.....	106
Table 28: Orderable Product Part Numbers.....	111

1. INTRODUCTION

1.1 Purpose

The Zynq Ultrascale+ MPSoC (ZU11/17/19EG) SOM Development platform incorporates Zynq Ultrascale+ MPSoC (ZU11/17/19EG) based SOM and Ultra-High-Performance Carrier board for complete validation of Zynq Ultrascale+ MPSoC (ZU11/17/19EG) functionality. This document is the Hardware User Guide for the Zynq Ultrascale+ MPSoC (ZU11/17/19EG) Carrier Board and provides detailed information on the overall design & usage of the Carrier Board from a Hardware Systems perspective. The details about the Zynq Ultrascale+ MPSoC (ZU11/17/19EG) SOM hardware is explained in another document “iW-RainboW-G35M-Zynq-Ultrascale+MPSoC(ZU11/17/19EG)-SOM-HardwareUserGuide”.

1.2 Overview

iWave's Zynq Ultrascale+ MPSoC (ZU11/17/19EG) Development platform comes with Zynq Ultrascale+ MPSoC (ZU11/17/19EG) SOM and the Ultra-High-Performance Carrier Board. The development board can be used for quick prototyping of various applications targeted by the Zynq Ultrascale+ MPSoC (ZU11/17/19EG). With the 140mmx170mm size, carrier board is packed with all the necessary on-board connectors to validate the features of Zynq Ultrascale+ MPSoC (ZU11/17/19EG) SOM.

1.3 List of Acronyms

The following acronyms will be used throughout this document.

Table 2: Acronyms & Abbreviations

Acronyms	Abbreviations
ARM	Advanced RISC Machine
B2B	Board to Board
CAN	Controller Area Network
CH	Channel
CMOS	Complementary Metal Oxide Semiconductor
DP	Display Port
FPGA	Field Programmable Gate Array
FMC	FPGA Mezzanine Card
FMC+	FPGA Mezzanine Card Plus
Gbps	Gigabits per sec
GEM	Gigabit Ethernet Controller
GPIO	General Purpose Input Output
HDMI	High Definition Multimedia Interface
HPC	High Pin Count
I2C	Inter-Integrated Circuit
IC	Integrated Circuit

Acronyms	Abbreviations
JTAG	Joint Test Action Group
LVC MOS	Low Voltage Complementary Metal Oxide Semiconductor
LVDS	Low Voltage Differential Signal
Mbps	Megabits per sec
MHz	Mega Hertz
NC	No Connect
NPTH	Non Plated Through Hole
PCB	Printed Circuit Board
PCIe	Peripheral Component Interconnect Express
PMOD	Peripheral Module
PTH	Plated Through Hole
RGMII	Reduced Gigabit Media Independent Interface
RTC	Real Time Clock
RX	Receiver
SATA	Serial Advanced Technology Attachment
SDI	Serial Digital Interface
SDIO	Secure Digital Input Output
SDHI	SD Card Host Interface
SFP	Small Form-factor Pluggable
SOM	System On Module
TXVR	Transceiver
TX	Transmitter
UART	Universal Asynchronous Receiver/Transmitter
USB	Universal Serial Bus
USB OTG	USB On The Go
QSFP+	Quad Small Form-factor Pluggable

Terminology Description

In this document, wherever Signal Type is mentioned, below terminology is used.

Table 3: Terminology

Terminology	Description
I	Input Signal
O	Output Signal
IO	Bidirectional Input/output Signal
CMOS	Complementary Metal Oxide Semiconductor Signal
DIFF	Differential Signal
OD	Open Drain Signal
OC	Open Collector Signal
Analog	Analog Signal
Power	Power Pin
PU	Pull Up
PD	Pull Down
NA	Not Applicable
NC	Not Connected

Note: Signal Type does not include internal pull-ups or pull-downs implemented by the chip vendors and only includes the pull-ups or pull-downs implemented on board.

1.4 References

- Zynq Ultrascale+ MPSoC Datasheet & Reference Manual
- Zynq Ultrascale+ MPSoC (ZU11/17/19EG) SOM Hardware User Guide

2. ARCHITECTURE AND DESIGN

This section provides detailed information about the Zynq Ultrascale+ MPSoC (ZU11/17/19EG) Development platform carrier board features with high level block diagram and detailed information about each block.

2.1 Zynq Ultrascale+ MPSoC (ZU11/17/19EG) SOM Carrier Board Block Diagram

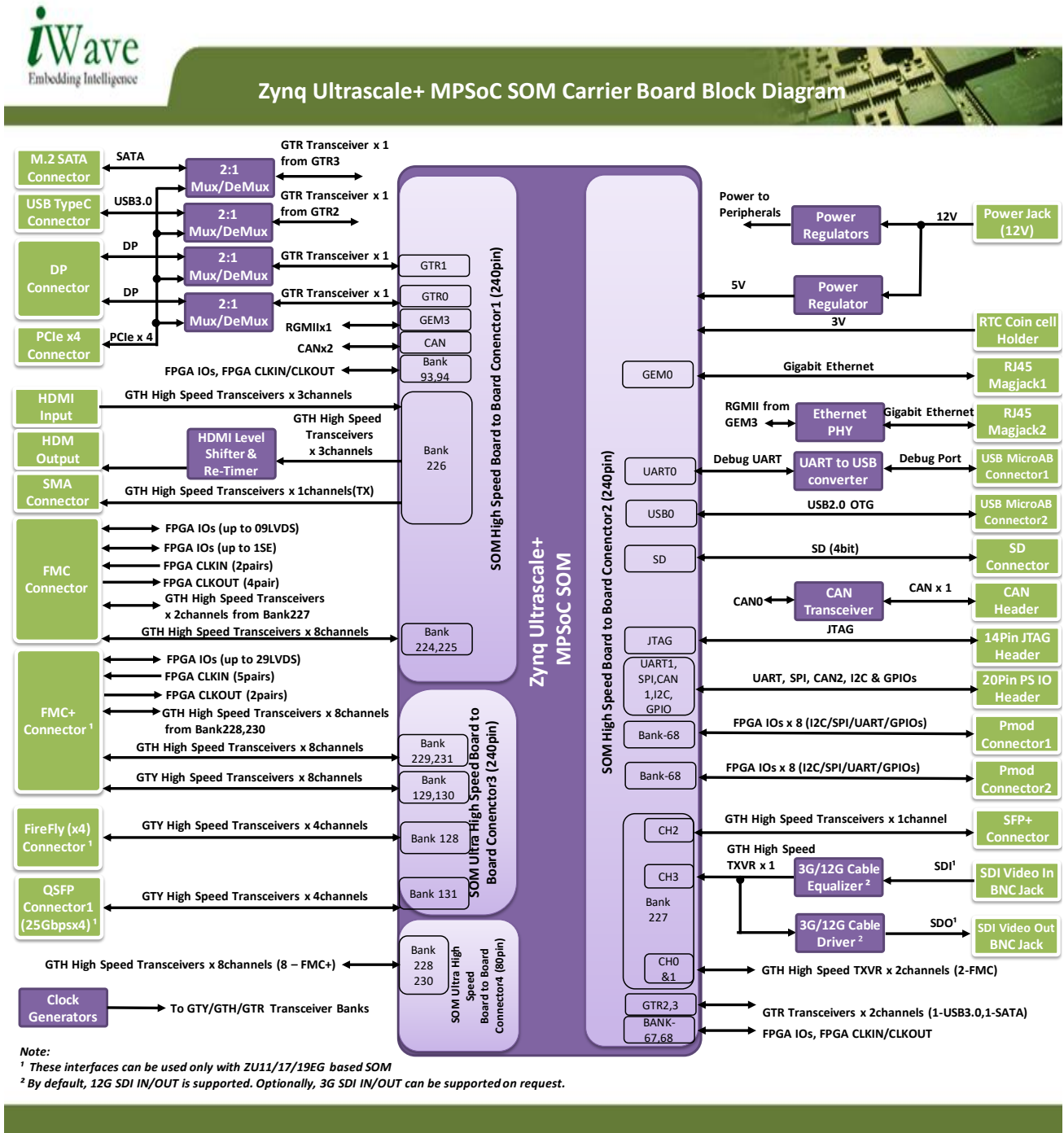

Figure 1: Zynq Ultrascale+ MPSoC (ZU11/17/19EG) SOM Carrier Board Block Diagram

2.2 Zynq Ultrascale+ MPSoC (ZU11/17/19EG) SOM Carrier Board Features

The Zynq Ultrascale+ MPSoC (ZU11/17/19EG) Carrier board supports the following features to validate the Zynq Ultrascale+ MPSoC (ZU11/17/19EG) SOM supported interfaces.

PS Interface Features

- PS GTR Features:
 - PCIe1 Connector x 1
 - Display Port Connector x 1
 - USB 3.0 OTG through Type C Connector x 1
 - M.2 SATA Connector x 1
- Gigabit Ethernet through RJ45MagJack (GEM0) x 1
- Gigabit Ethernet through RJ45MagJack (GEM3) x 1
- USB2.0 OTG through Micro AB Connector x 1
- Standard SD Connector x 1
- CAN Header x 1
- Debug UART through USB Micro AB Connector x 1

PL Interface Features

- SFP+ Connector x 1
- SDI Video IN through HD BNC Connector x 1
- SDI Video OUT through HD BNC Connector x 1
- HDMI IN x 1
- HDMI OUT x 1
- QSFP28/QSFP+/QSFP Connector x 1
- FireFly Connector x 1
- FMC High Pin Count (HPC) Connector
 - 10 GTH High Speed Transceivers
 - 2 GTH Reference Clock
 - Upto 06 LVDS IOs/12 Single ended (SE) IOs from HP Bank
 - Upto 03 DIFF IOs/06 Single ended (SE) IOs from HD Bank
 - 2 Clock Input Capable LVDS/SE pins from HP Bank
 - 1 Clock Output Capable LVDS/SE pins from HP Bank
 - 3 Clock Output Capable DIFF/SE pins from HD Bank
 - Upto 1 Single ended (SE) IOs

- FMC+ High Pin Count (HPC) Connector
 - 8 GTY High Speed Transceivers
 - 2 GTY Reference Clock
 - 16 GTH High Speed Transceivers
 - 4 GTH Reference Clock
 - Upto 20 LVDS IOs/40 Single ended (SE) IOs from HP Bank
 - Upto 09 DIFF IOs/18 Single ended (SE) IOs from HD Bank
 - 2 Clock Input Capable LVDS/SE pins from HP Bank
 - 3 Clock DIFF Capable LVDS/SE pins from HD Bank
 - 2 Clock Output Capable LVDS/SE pins from HP Bank
- PMOD Connector x 2
- SMA Connector x 2

Additional Features

- Clock Synthesizers/Generators x2
- JTAG Connector x 1
- 16-Bit IO Expanders x 3
- I2C Expander x 1
- 20 Pin GPIO Header x 1
- Power ON/OFF DIP Switch x 1
- Reset Pushbutton Switch x 1
- RTC Coin Cell Holder x 1
- 12V FAN Header x 1

General Specification

- Power Supply : DC 12V, 14A Power Input Jack
- Form Factor : 140mm X 170mm

2.3 Board to Board Connectors

The Zynq Ultrascale+ MPSoC (ZU11/17/19EG) carrier board supports four Board to Board mating connectors for Zynq Ultrascale+ MPSoC SOM attachment. This Board to Board connector are capable of handling high-speed serialized signals and can be used for size constrained embedded applications.

2.3.1 Board to Board Connector1

Board to Board Connector1 (J18) is physically located at the top of the board as shown below.

Note: For the Board to Board Connector1 pinout, refer the Zynq Ultrascale+ MPSoC (ZU11/17/19EG) SOM Hardware User Guide.

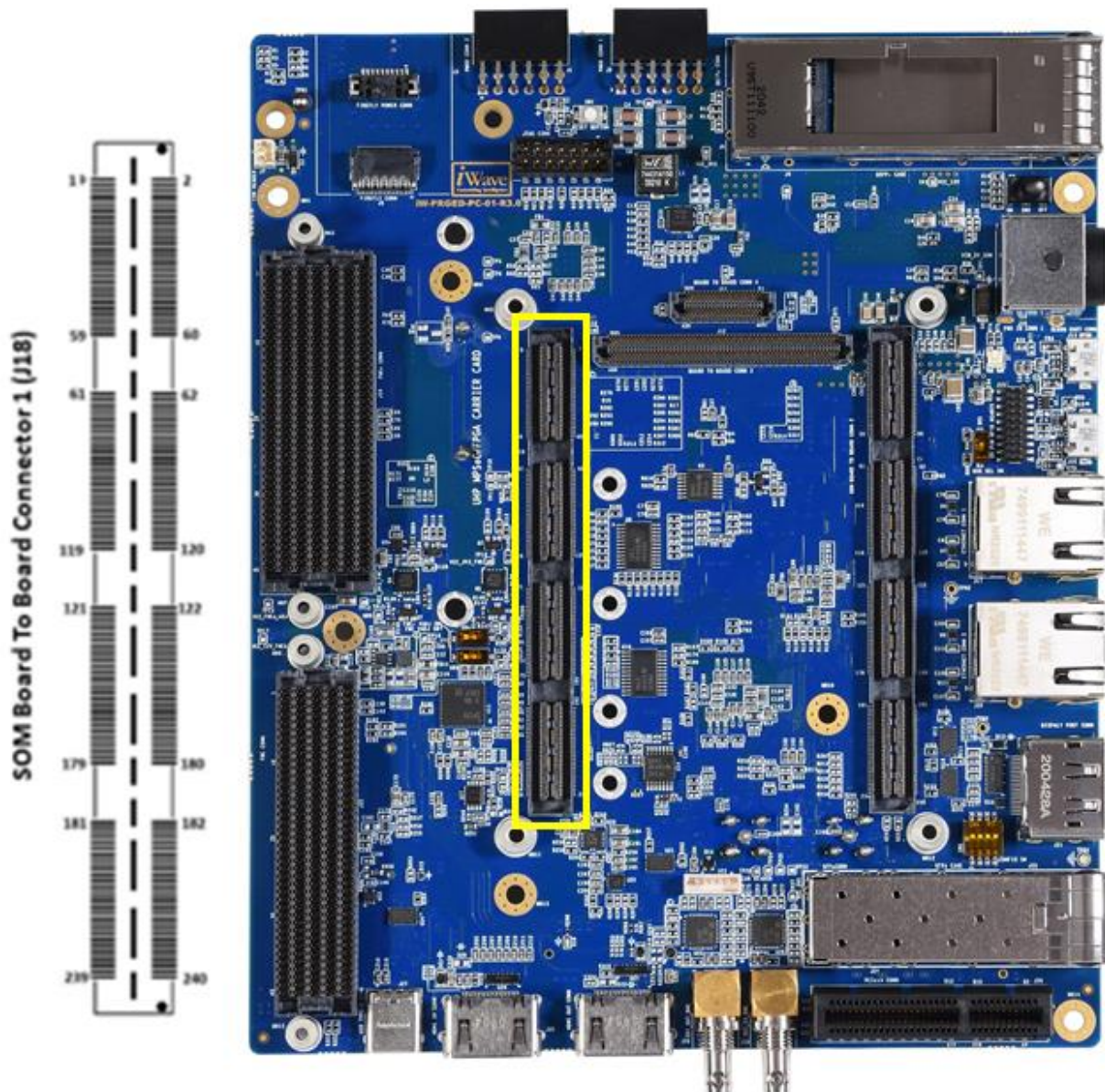

Figure 2: Board to Board Connector1

2.3.2 Board to Board Connector2

Board to Board Connector2 (J19) is physically located at the top of the board as shown below.

Note: For the Board to Board Connector2 pinout, refer the Zynq Ultrascale+ MPSoC (ZU11/17/19EG) SOM Hardware User Guide.

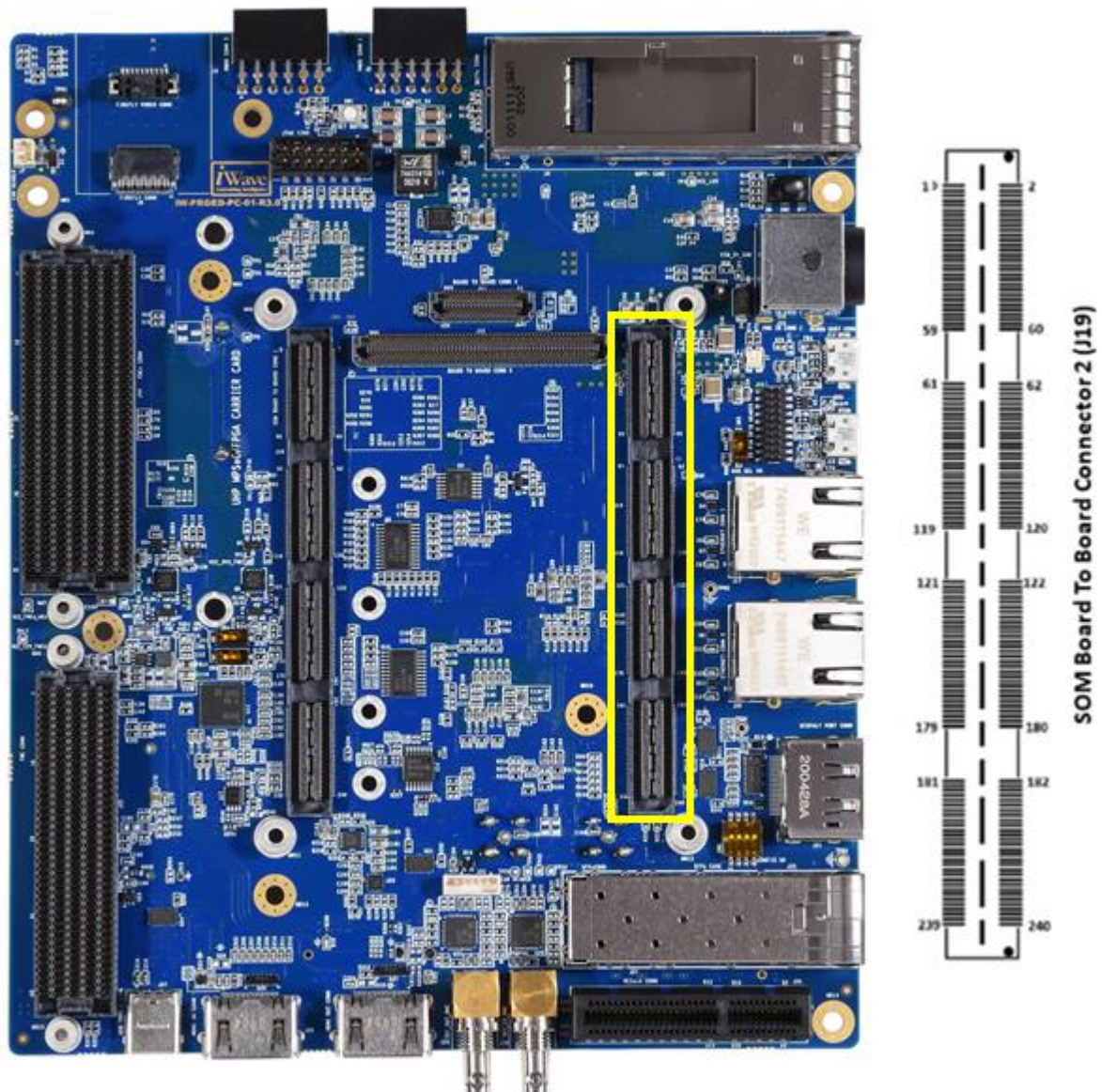

Figure 3: Board to Board Connector2

2.3.3 Board to Board Connector3

Board to Board Connector3 (J12) is physically located at the top of the board as shown below.

Note: For the Board to Board Connector3 pinout, refer the Zynq Ultrascale+ MPSoC (ZU11/17/19EG) SOM Hardware User Guide.

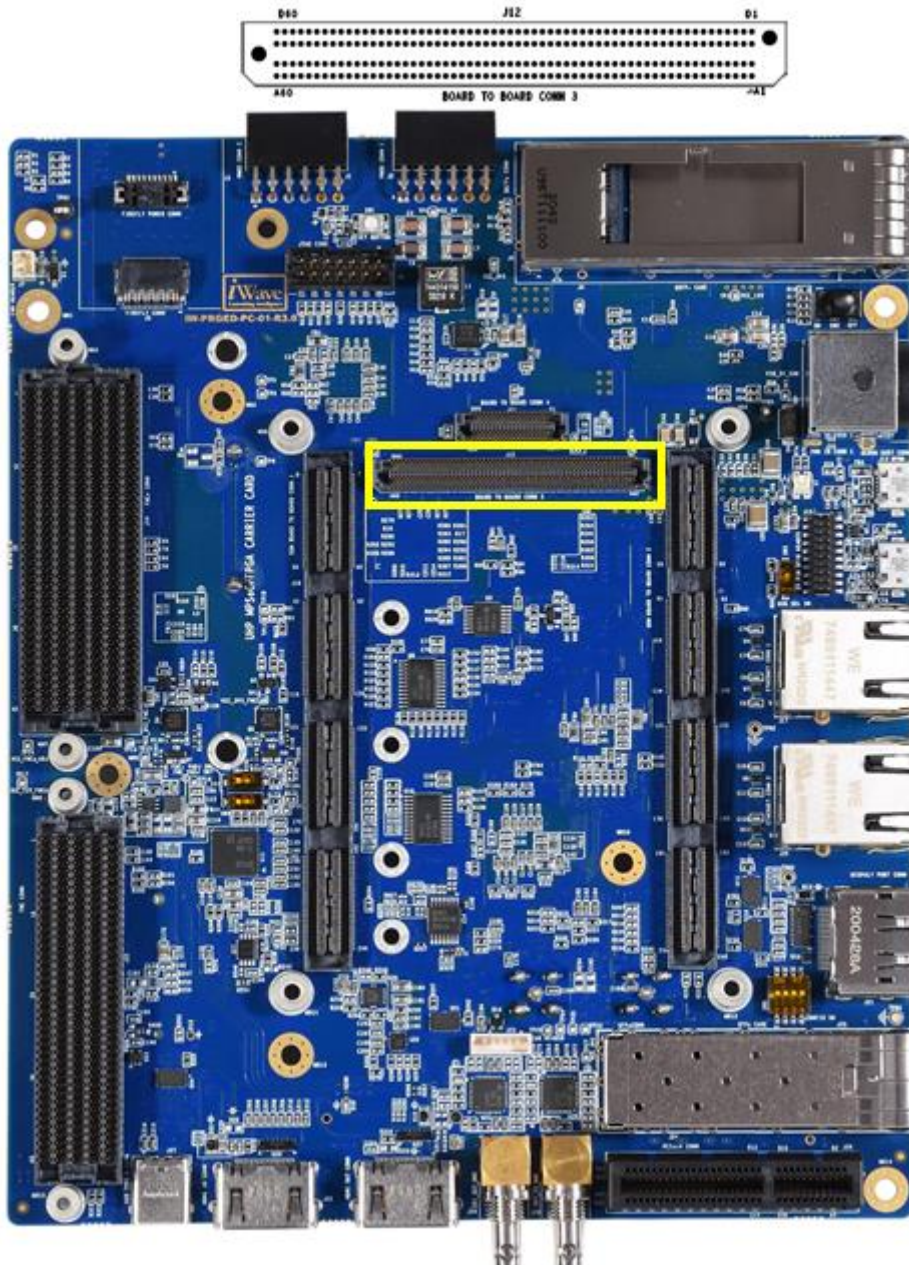

Figure 4 Board to Board Connector3

2.3.4 Board to Board Connector4

Board to Board Connector3 (J11) is physically located at the top of the board as shown below.

Note: For the Board to Board Connector4 pinout, refer the Zynq Ultrascale+ MPSoC (ZU11/17/19EG) SOM Hardware User Guide.

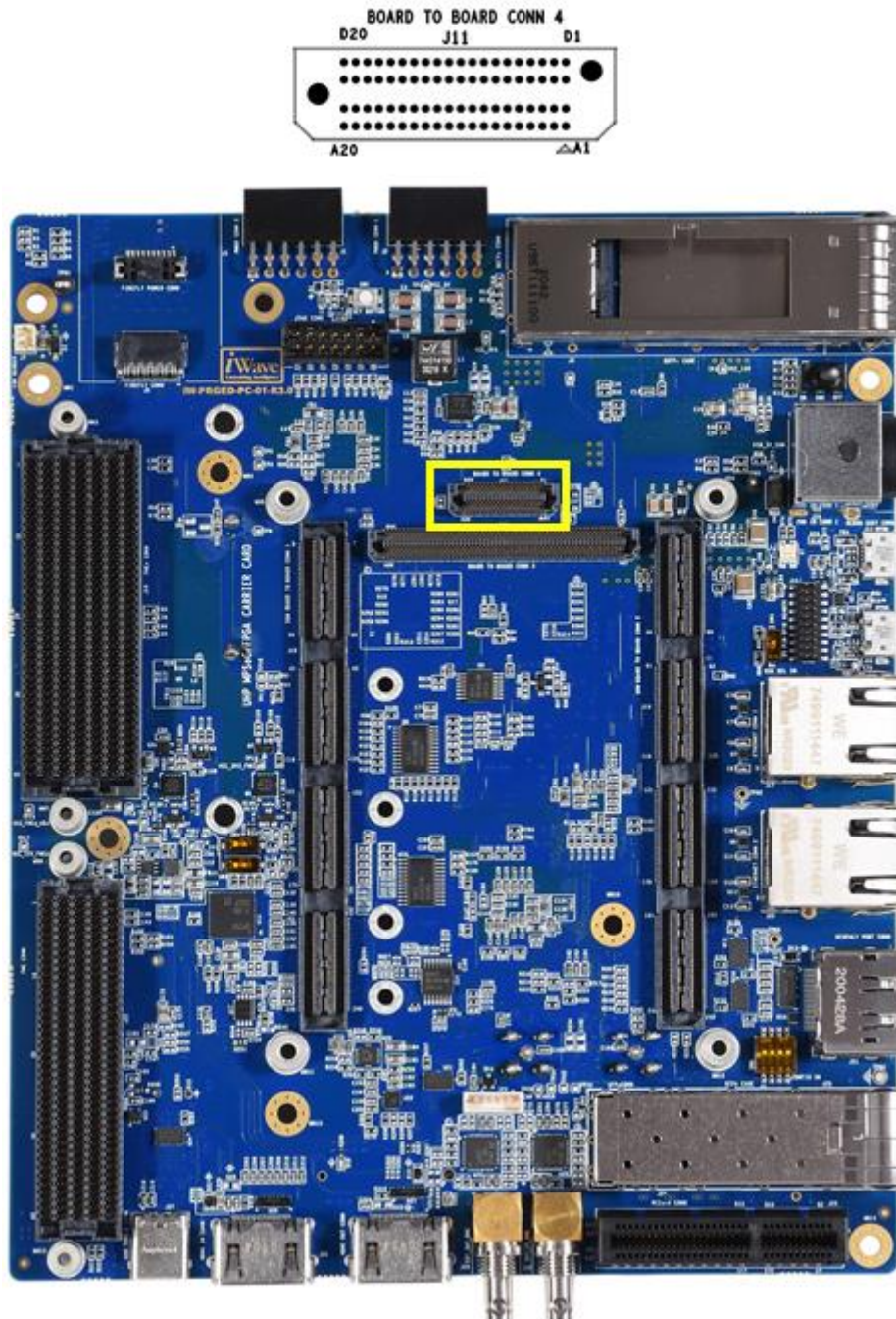

Figure 5 Board to Board Connector4

2.4 PS Interface Features

The features which are supported from Zynq Ultrascale+ MPSoC (ZU11/17/19EG) PS is explained in the following section.

2.4.1 PS-GTR Transceivers

The Zynq Ultrascale+ MPSoC (ZU11/17/19EG) Carrier board supports different high speed interfaces through four PS-GTR lanes (two from B2B-1 and two from B2B-2). Each PS-GTR lane is connected to High speed MUX/DEMUX IC to support different high speed interfaces as mentioned below.

- x1, x2, or x4 lane of PCIe at Gen1 (2.5Gb/s) or Gen2 (5.0Gb/s) rates
- 1 or 2 lanes of DisplayPort (TX only) at 1.62Gb/s, 2.7Gb/s, or 5.4Gb/s
- 1 SATA port at 1.5Gb/s, 3.0Gb/s, or 6.0Gb/s
- 1 USB3.0 port at 5.0Gb/s

The MUX/DEMUX connection and interface selection option is shown below for easy understanding. The selection control of each MUX IC is connected to PS-GTR Lane selection 4bit DIP switch (SW6).

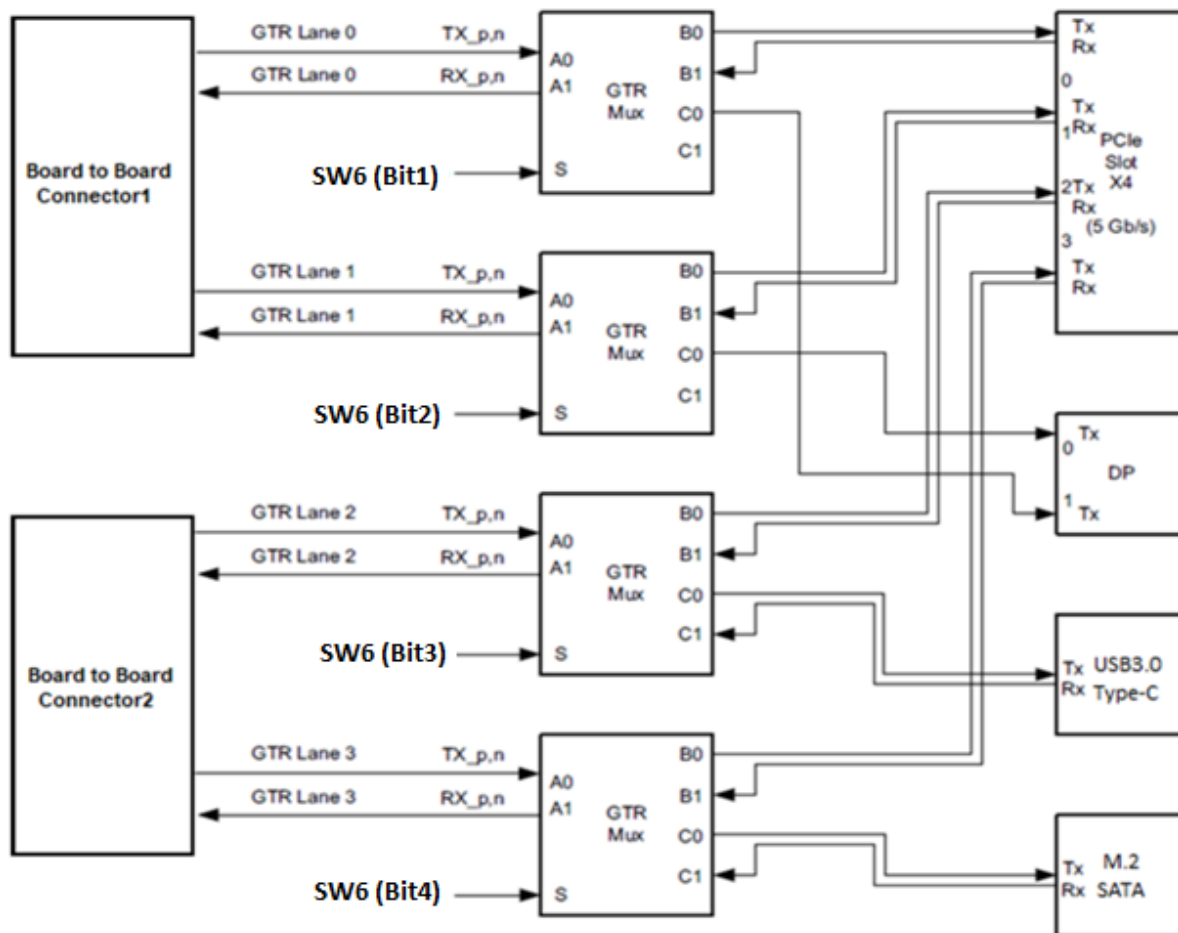

Figure 6: PS-GTR External Switch Connectivity.

The PS-GTR Lane selection switch (SW6) setting and corresponding interface selection option is explained below.

Table 4: PS-GTR Lane Selection Switch Setting

PS-GTR Lanes	PS-GTR Lane Selection Switch (SW6)		
	Switch Bit Number	Switch Bit Position	
		OFF	ON
Lane0	Bit1	PS-GTR Lane0 is connected to Lane0 of PCIe x4 connector (default)	PS-GTR Lane0 is connected to Lane1 of DP connector
Lane1	Bit2	PS-GTR Lane1 is connected to Lane1 of PCIe x4 connector	PS-GTR Lane1 is connected to Lane0 of DP connector (default)
Lane2	Bit3	PS-GTR Lane2 is connected to Lane2 of PCIe x4 connector	PS-GTR Lane2 is connected to Lane1 of USB3.0 Type-C connector (default)
Lane3	Bit4	PS-GTR Lane3 is connected to Lane3 of PCIe x4 connector	PS-GTR Lane3 is connected to M.2 SATA connector (default)

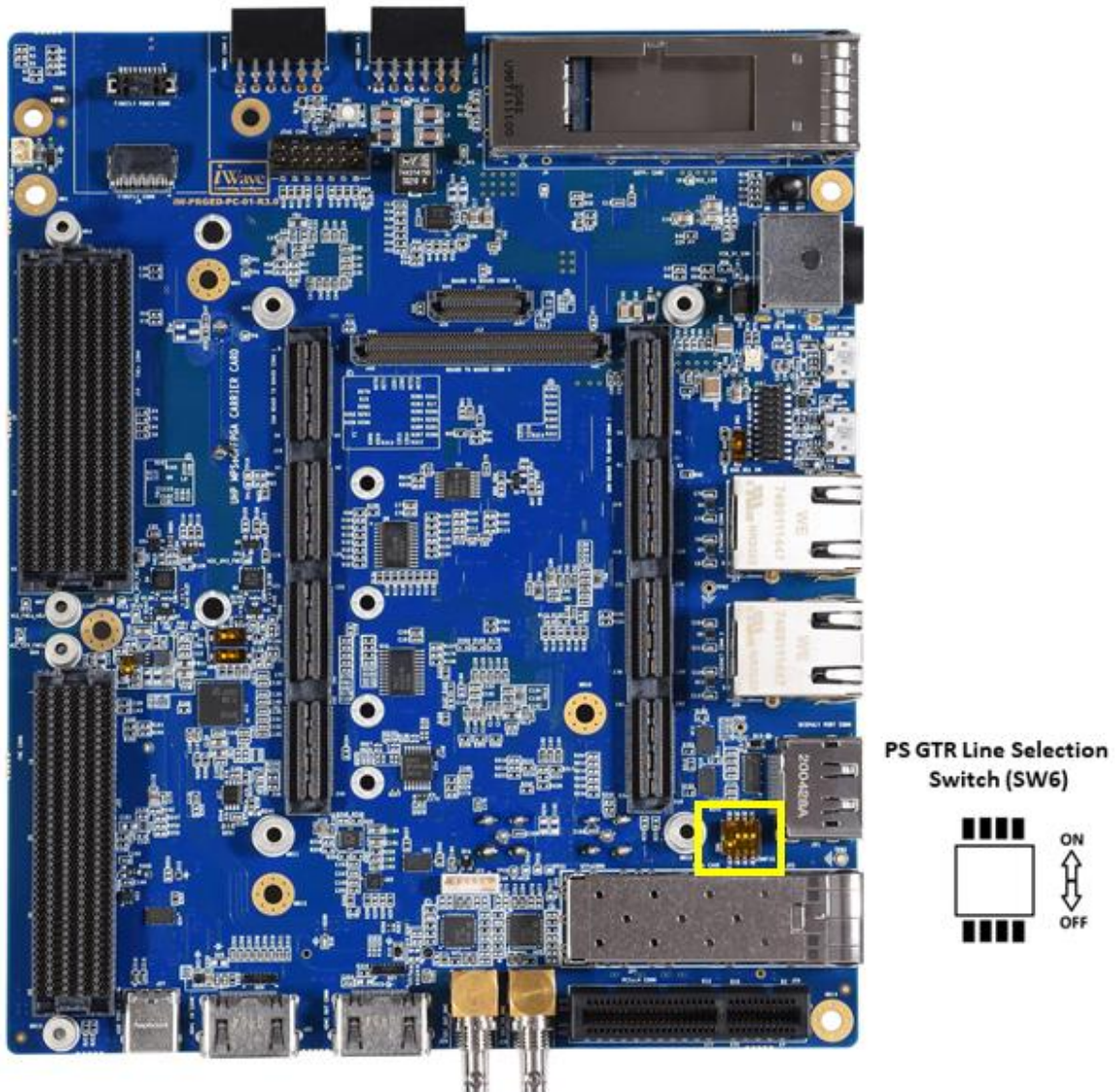

Figure 7: PS-GTR Lane Selection Switch

2.4.1.1 PCIe x4 Connector

The Zynq Ultrascale+ MPSoC (ZU11/17/19EG) Carrier board supports one PCIe x4 connector through PS-GTR Lanes of Zynq Ultrascale+ MPSoC (ZU11/17/19EG) PS. All the four PS-GTR lanes from Board to Board Connectors are connected to PCIe x4 connector to support x1, x2 & x4 PCIe devices. The PS-GTR Lane selection to PCIe x4 connector is done through PS-GTR Lane Selection Switch (SW6). The Carrier board provides 100MHz reference clock to PCIe x4 connector from on board Clock Synthesizer1. This PCIe x4 connector (J26) is physically located at the top of the board as shown below.

*Note: For more details on PS-GTR Lane selection options, refer **Table 4**.*

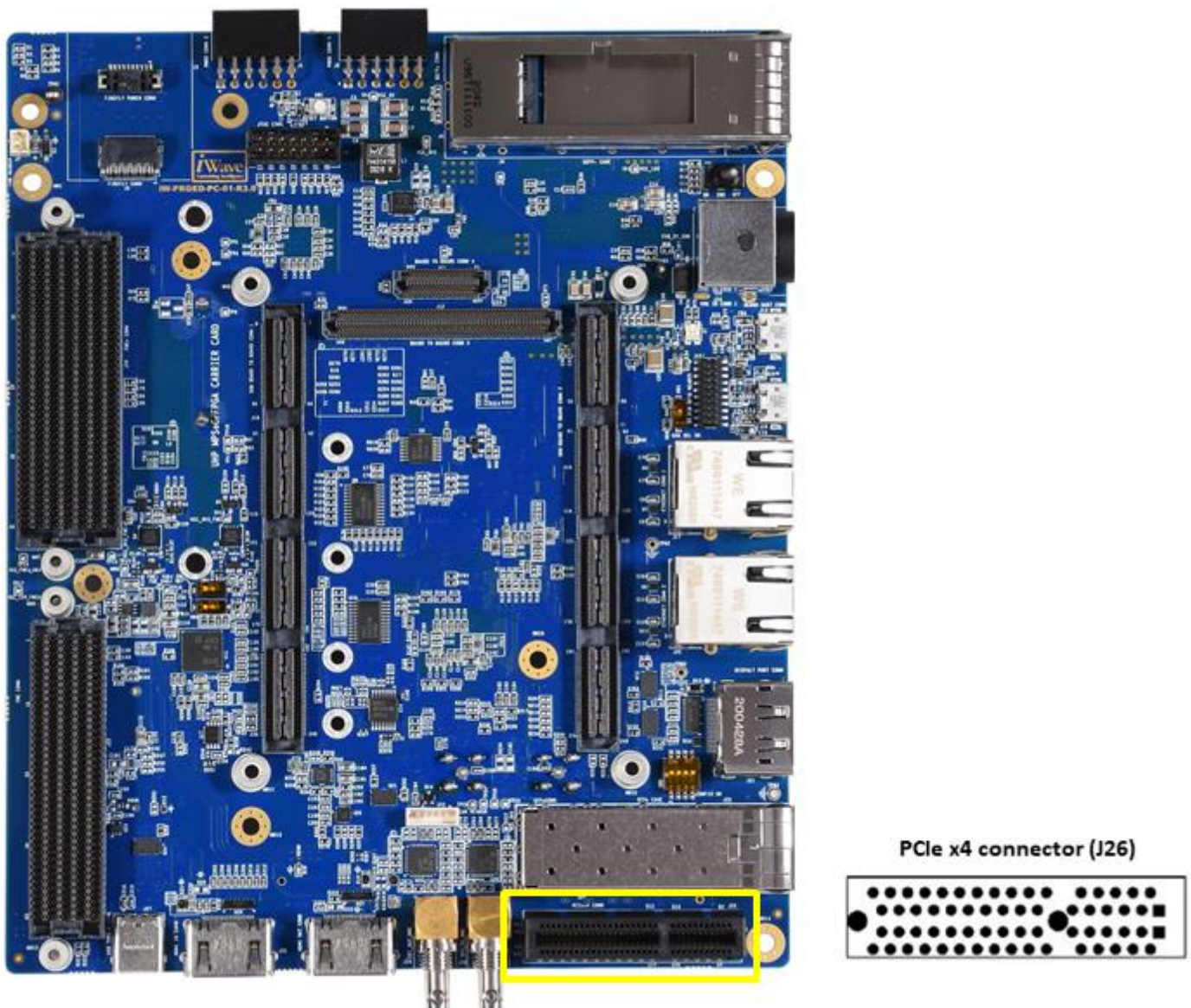

Figure 8: PCIe x4 Connector

Table 5: PCIe x4 Connector Pin Assignment

Pin No	Pin Name	Signal Name	Signal Type/ Termination	Description
A1	PRSNT1#	PRSNT1#	O, 3.3V CMOS	Default Grounded.
A2	+12V	VCC_12V	O, 12V Power	12V Supply Voltage.
A3	+12V	VCC_12V	O, 12V Power	12V Supply Voltage.
A4	GND	GND	Power	Ground.
A5	TCK	NA	NA	NC.
A6	TDI	NA	NA	NC.
A7	TDO	NA	NA	NC.
A8	TMS	NA	NA	NC.
A9	+3V3	VCC_3V3	O, 3.3V Power	3.3V Supply Voltage.
A10	+3V3	VCC_3V3	O, 3.3V Power	3.3V Supply Voltage.
A11	PERST#	PL_E3_LVDS94_L3P	O, 3.3V CMOS	PCIe Reset through PL Bank IO.
A12	GND	GND	Power	Ground.
A13	REFCLK+	PCIe_REFCLKP	O, DIFF	100MHz PCIe Reference Clock positive.
A14	REFCLK-	PCIe_REFCLKn	O, DIFF	100MHz PCIe Reference Clock negative.
A15	GND	GND	Power	Ground.
A16	PERp0	PS_MGTRRXPO_505	I, DIFF	PCIe Lane0 Receive pair positive.
A17	PERn0	PS_MGTRRXNO_505	I, DIFF	PCIe Lane0 Receive pair negative.
A18	GND	GND	Power	Ground.
A19	RSVD	NA	NA	NC.
A20	GND	GND	Power	Ground.
A21	PERp1	PS_MGTRRX1_505	NA	PCIe Lane1 Receive pair positive.
A22	PERn1	PS_MGTRRXN1_505	NA	PCIe Lane1 Receive pair negative
A23	GND	GND	Power	Ground.
A24	GND	GND	Power	Ground.
A25	PERp2	PS_MGTRRX2_505	NA	PCIe Lane2 Receive pair positive.
A26	PERn2	PS_MGTRTXN2_505	NA	PCIe Lane2 Receive pair negative.
A27	GND	GND	Power	Ground.
A28	GND	GND	Power	Ground.
A29	PERp3	PS_MGTRRX3_505	NA	PCIe Lane3 Receive pair positive.
A30	PERn3	PS_MGTRRXN3_505	NA	PCIe Lane3 Receive pair negative.
A31	GND	GND	Power	Ground.
A32	RSVD	NA	NA	NC.
B1	+12V	VCC_12V	O, 12V Power	12V Supply Voltage.
B2	+12V	VCC_12V	O, 12V Power	12V Supply Voltage.
B3	RSVD	NA	NA	NC.
B4	GND	GND	Power	Ground.
B5	SMCLK	I2C0_SCL(PS_MIO10_500)	O, 3.3V CMOS	SMB Clock.
B6	SMDAT	I2C0_SDA(PS_MIO11_500)	IO, 3.3V CMOS	SMB DATA.
B7	GND	GND	Power	Ground.
B8	+3V3	VCC_3V3	O, 3.3V Power	3.3V Supply Voltage.
B9	TRST#	NA	NA	NC.

Pin No	Pin Name	Signal Name	Signal Type/ Termination	Description
B10	3V3AUX	VCC_3V3_AUX	O, 3.3V Power	3.3V Supply Voltage
B11	WAKE#	PL_E2_LVDS94_L3N	O, 3.3V CMOS	PCIe Wake through PL Bank IO.
B12	RSVD	NA	NA	NC.
B13	GND	GND	Power	Ground.
B14	PETp0	PS_MGTRTXP0_505	O, DIFF	PCIe Lane0 Transmit pair positive.
B15	PETn0	PS_MGTRTXN0_505	O, DIFF	PCIe Lane0 Transmit pair negative.
B16	GND	GND	Power	Ground.
B17	PRSNT2	NA	NA	NC.
B18	GND	GND	Power	Ground.
B19	PETp1	PS_MGTRTXP1_505	NA	PCIe Lane1 Transmit pair positive.
B20	PETn1	PS_MGTRTXN1_505	NA	PCIe Lane1 Transmit pair negative
B21	GND	GND	Power	Ground.
B22	GND	GND	Power	Ground.
B23	PETp2	PS_MGTRTXP2_505	NA	PCIe Lane2 Transmit pair positive.
B24	PETn2	PS_MGTRTXN2_505	NA	PCIe Lane2 Transmit pair negative
B25	GND	GND	Power	Ground.
B26	GND	GND	Power	Ground.
B27	PETp3	PS_MGTRTXP3_505	NA	PCIe Lane3 Transmit pair positive.
B28	PETn3	PS_MGTRTXN3_505	NA	PCIe Lane3 Transmit pair negative
B29	GND	GND	Power	Ground.
B30	RSVD	NA	NA	NC.
B31	PRSNT#2	NA	NA	NC.
B32	GND	GND	Power	Ground.

2.4.1.2 Display Port Connector

The Zynq Ultrascale+ MPSoC (ZU11/17/19EG) Carrier board supports one Display port connector through PS-GTR Lanes of Zynq Ultrascale+ MPSoC (ZU11/17/19EG) PS. PS-GTR Lane0 & Lane1 from Board to Board Connector1 is connected to Display port connector to support single or dual lane display port. The PS-GTR Lane selection to Display port connector is done through PS-GTR Lane Selection Switch (SW6).

The Display port connector supports AUX+ & AUX- signals from the PL Bank IOs. Also it supports Hot plug detect signal and connected to PL Bank IO. This Display Port connector (J21) is physically located at the top of the board as shown below.

*Note: For more details on PS-GTR Lane selection options, refer **Table 4**.*

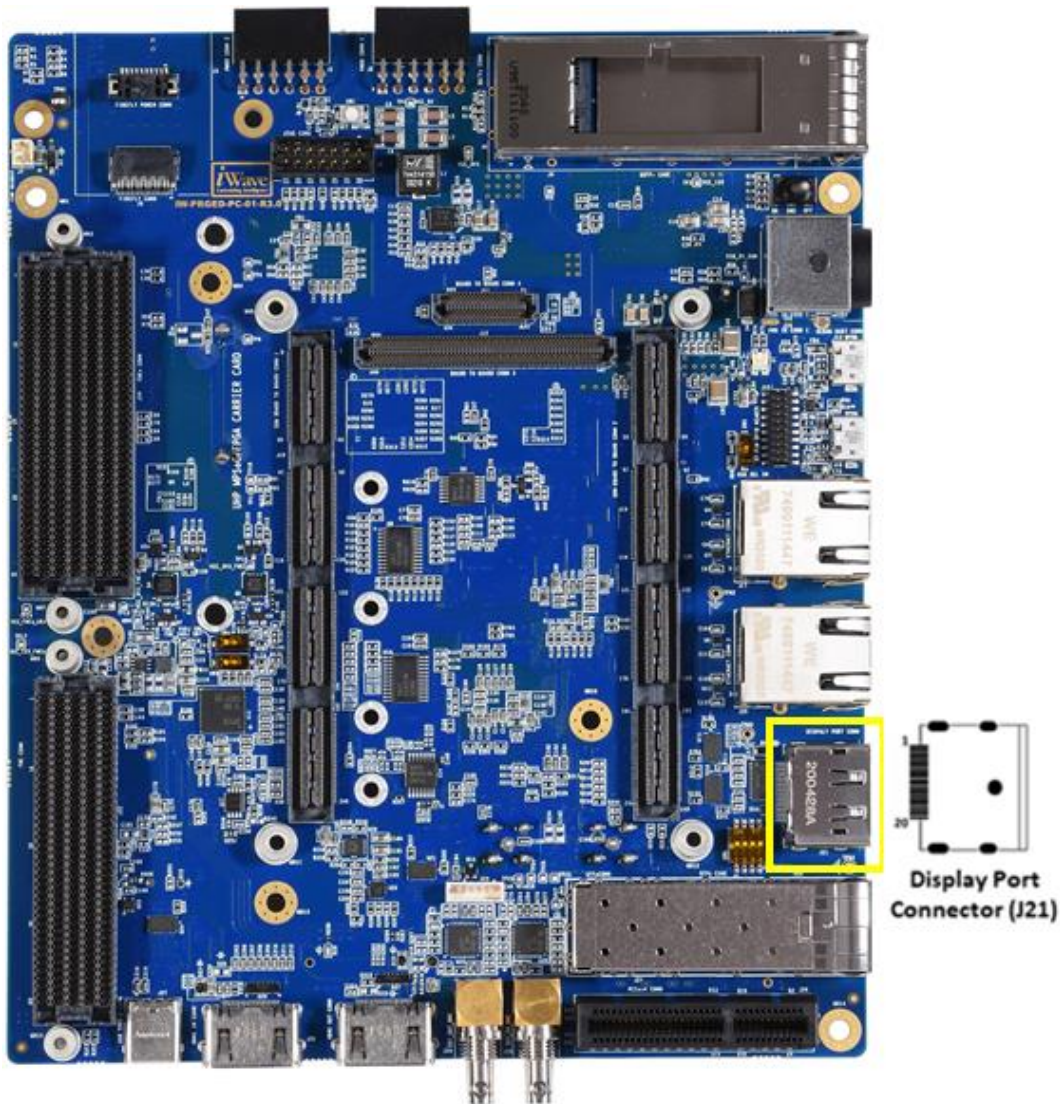

Figure 9: Display Port Connector

2.4.1.3 USB Type-C Connector

The Zynq Ultrascale+ MPSoC (ZU11/17/19EG) Carrier board supports one Super Speed USB3.0 OTG through USB Type-C connector. The PS-GTR Lane2 of Zynq Ultrascale+ MPSoC (ZU11/17/19EG) PS from Board to Board Connector2 is used for USB3.0 OTG interface. The PS-GTR Lane2 selection to USB Type-C connector is done through PS-GTR Lane Selection Switch (SW6). For more details on PS-GTR Lane selection options, refer **Table 4**.

The Zynq Ultrascale+ MPSoC (ZU11/17/19EG) Carrier board supports “FUSB302” USB Type-C controller for port detection & cable orientation and controlled through I2C0 interface of MPSoC PS. To support double-way plug in on USB Type-C connector, PS-GTR Lane2 is connected to “FUSB340” 2:1 data Switch and then connected to USB TypeC connector. The lane selection to Type-C connector (top or bottom port) is controlled through PL Bank IO “PL_B6_LVDS94_L11P” from Board to Board Connector1 pin70.

Also USB2.0 OTG interface of MPSoC PS is connected to USB Type-C connector for backward compatible USB2.0 support. The USB2.0 PHY Transceiver output signals from Board to Board connector2 is connected to “FUSB340” USB Switch for selecting the USB2.0 OTG connection between USB2.0 MicroAB connector (J16) and USB3.0 Type-C connector (J27). The selection can be done by setting the Single bit DIP switch (SW3). If the DIP switch (SW3) is set to ON, USB2.0 OTG is connected to MicroAB connector (J16) and if the DIP switch (SW3) is set to OFF, USB2.0 OTG is connected to USB3.0 TypeC connector (J27).

The USB3.0 OTG port can be used as full functional OTG functionality which supports USB3.0 host and USB2.0 device based on Type-C . The VBUS power of this USB Type-C connector is connected through current limit power switch which can be used to switch On/Off the power based on the device or Host and also limits the current above 900mA in host mode. Enable pin of the USB Power switch is connected to the PS GPIO “PS_MIO25_500” from Board to Board connector2 pin38. This USB Type-C connector (J27) is physically located at the top of the board as shown below.

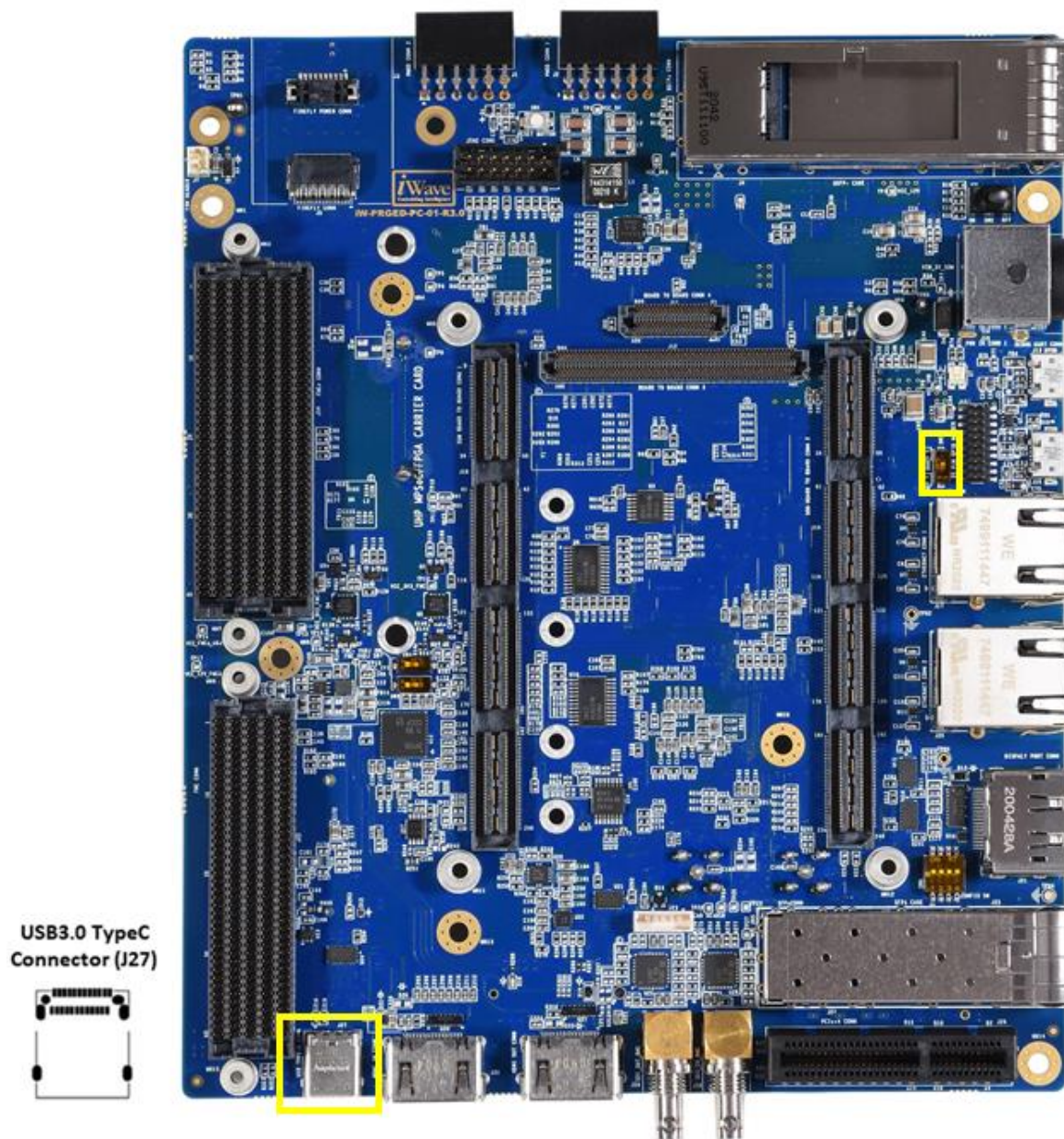

Figure 10: USB Type-C Connector

Table 6: USB TypeC Pin Assignment

Pin No	Pin Name	Signal Name	Signal Type/ Termination	Description
A1	GND	GND	Power	Ground.
A2	SSTXp1	PS_MGTRTXP2_505	O, DIFF	USB3.0 Super Speed Transmit Data Positive.
A3	SSTXn1	PS_MGTRTXN2_505	O, DIFF	USB3.0 Super Speed Transmit Data Negative.
A4	VBUS	VBUS_USB	Power	5V Power Supply.
A5	CC1	CC1	O, 5V CMOS	Configuration Channel pin1.
A6	Dp1	USB_OTG_DP	IO, DIFF	USB2.0 Transmit Data Positive.
A7	Dn1	USB_OTG_DM	IO, DIFF	USB2.0 Transmit Data Negative.
A8	SBU1	NC	NC	NC.
A9	VBUS	VBUS_USB	Power	5V Power Supply.
A10	SSRXn2	PS_MGTRRXN2_505	I, DIFF	USB3.0 Super Speed Receive Data Negative.
A11	SSRXp2	PS_MGTRRXP2_505	I, DIFF	USB3.0 Super Speed Receive Data Positive.
A12	GND	GND	Power	Ground.
B1	GND	GND	Power	Ground.
B2	SSTXp2	PS_MGTRTXP2_505	O, DIFF	USB3.0 Super Speed Transmit Data Positive.
B3	SSTXn2	PS_MGTRTXN2_505	O, DIFF	USB3.0 Super Speed Transmit Data Negative.
B4	VBUS	VBUS_USB	Power	5V Power Supply.
B5	CC2	CC2	O, 5V CMOS	Configuration Channel pin2.
B6	Dp2	USB_OTG_DP	IO, DIFF	USB2.0 Transmit Data Positive.
B7	Dn2	USB_OTG_DM	IO, DIFF	USB2.0 Transmit Data Negative.
B8	SBU2	NC	NC	NC.
B9	VBUS	VBUS_USB	Power	5V Power Supply.
B10	SSRXn1	PS_MGTRRXN2_505	I, DIFF	USB3.0 Super Speed Receive Data Negative.
B11	SSRXp1	PS_MGTRRXP2_505	I, DIFF	USB3.0 Super Speed Receive Data Positive.
B12	GND	GND	Power	Mechanical Pin.

2.4.1.4 M.2 SATA Connector

The Zynq Ultrascale+ MPSoC (ZU11/17/19EG) Carrier board supports one SATA interface through M.2 (Key M) SATA connector. PS-GTR3 Lane of Zynq Ultrascale+ MPSoC (ZU11/17/19EG) PS is used for SATA interface. MPSoC's SATA supports SATA Specification revision 3.1 with Gen1(1.5Gbps), Gen2(3Gbps) & Gen3(6Gbps) datarates. The PS-GTR Lane selection to M.2 SATA connector is done through PS-GTR Lane Selection Switch (SW6). For more details on PS-GTR Lane selection options, refer **Table 4**. This M.2SATA connector (J36) is physically located at the bottom of the board as shown below.

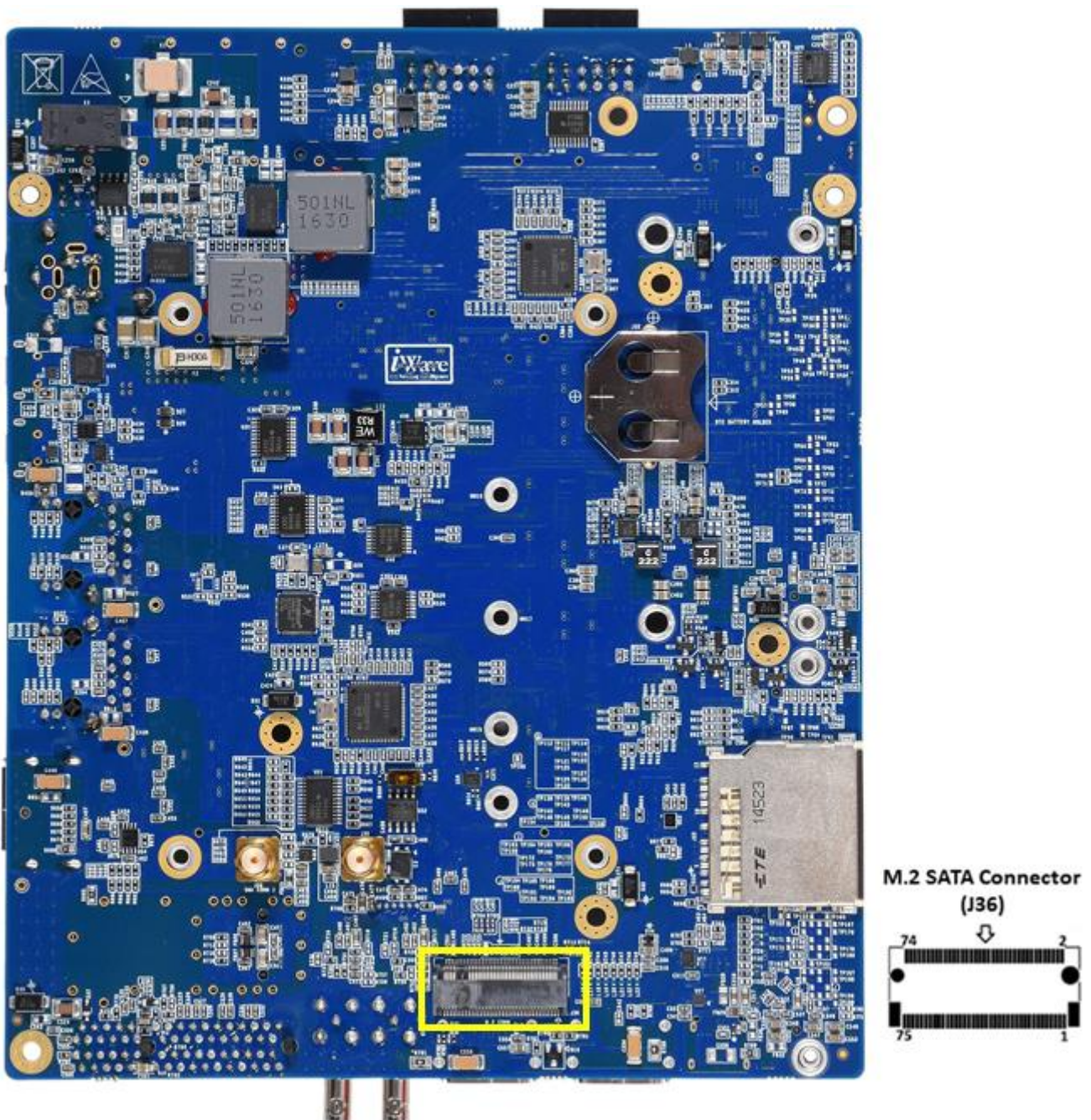

Figure 11: M.2 SATA Connector (Key M)

Table 7: M.2 SATA Connector Pin Assignment

Pin No	Pin Name	Signal Name	Signal Type/ Termination	Description
1	CONFIG_3	NA	NA	NC
2	3.3V	VCC_3V3	O, 3.3V Power	Supply Voltage.
3	GND	GND	Power	Ground.
4	3.3V	VCC_3V3	O, 3.3V Power	Supply Voltage.
5	PERn3	NA	NA	NC.
6	N/A1	NA	NA	NC.
7	PERp3	NA	NA	NC.
8	N/A2	NA	NA	NC.
9	GND	GND	Power	Ground.
10	DAS/DSS	DAS	IO, 3.3V CMOS	Connected to LED D20 for the activity indication
11	PETn3	NA	NA	NC.
12	3.3V	VCC_3V3	O, 3.3V Power	Supply Voltage.
13	PETp3	NA	NA	NC.
14	3.3V	VCC_3V3	O, 3.3V Power	Supply Voltage.
15	GND	GND	Power	Ground.
16	3.3V	VCC_3V3	O, 3.3V Power	Supply Voltage.
17	PERn2	NA	NA	NC.
18	3.3V	VCC_3V3	O, 3.3V Power	Supply Voltage.
19	PERp2	NA	NA	NC.
20	N/A3	NA	NA	NC.
21	CONFIG_0	NA	NA	NC
22	N/A4	NA	NA	NC.
23	PETn2	NA	NA	NC.
24	N/A5	NA	NA	NC.
25	PETp2	NA	NA	NC.
26	N/A6	NA	NA	NC.
27	GND	GND	Power	Ground.
28	N/A7	NA	NA	NC.
29	PERn1	NA	NA	NC.
30	N/A8	NA	NA	NC.
31	PERp1	NA	NA	NC.
32	N/A9	NA	NA	NC.
33	GND	GND	Power	Ground.
34	N/A10	NA	NA	NC.
35	PETn1	NA	NA	NC.
36	N/A11	NA	NA	NC.
37	PETp1	NA	NA	NC.
38	DEVSLP	NA	NA	NC.
39	GND	GND	Power	Ground.
40	SMB_CLK	NA	NA	NC.

Pin No	Pin Name	Signal Name	Signal Type/ Termination	Description
41	SATA-B+/PERn0	PS_MGTRRX3_505	I, DIFF	SATA Receive pair positive.
42	SMB_DATA	NA	NA	NC.
43	SATA-B-/PERp0	PS_MGTRRXN3_505	I, DIFF	SATA Receive pair negative.
44	N/A14	NA	NA	NC.
45	GND	GND	Power	Ground.
46	N/A15	NA	NA	NC.
47	SATA-A-/PETn0	PS_MGTRTXN3_505	O, DIFF	SATA Transmit pair negative.
48	N/A16	NA	NA	NC.
49	SATA-A+/PETp0	PS_MGTRTX3_505	O, DIFF	SATA Transmit pair positive.
50	PERST#	B_M2_PCI_RST#	O, 3.3V CMOS	This pin is connected to IO Expander port 14
51	GND	GND	Power	Ground.
52	CLKREQ#	B_PCI_CLKREQ#	I, 3.3V CMOS	This pin is connected to IO Expander port 16
53	REFCLKN	M2_PCl_e_REFCLKn	O, DIFF	PCIe reference clock pair negative.
54	PEWAKE#	B_M2_PCI_WAK#	O, 3.3V CMOS	This pin is connected to IO Expander port 15
55	REFCLKP	M2_PCl_e_REFCLKP	O, DIFF	PCIe reference clock pair positive.
56	MFG1	NA	NA	NC.
57	GND	GND	Power	Ground.
58	MFG2	NA	NA	NC.
59	M1	NA	NA	NC.
60	M2	NA	NA	NC.
61	M3	NA	NA	NC.
62	M4	NA	NA	NC.
63	M5	NA	NA	NC.
64	M6	NA	NA	NC.
65	M7	NA	NA	NC.
66	M8	NA	NA	NC.
67	N/A17	NA	NA	NC.
68	SUSCLK	NA	NA	NC.
69	CONFIG_1	PCI/SATA_CONFIG	Power, 10K PU	This pin is connected to VCC_3V3
70	3.3V	VCC_3V3	O, 3.3V Power	Supply Voltage.
71	GND	GND	Power	Ground.
72	3.3V	VCC_3V3	O, 3.3V Power	Supply Voltage.
73	GND	GND	Power	Ground.
74	3.3V	VCC_3V3	O, 3.3V Power	Supply Voltage.
75	CONFIG_2	NA	NA	NC

2.4.2 Gigabit Ethernet Port1

The Zynq Ultrascale+ MPSoC (ZU11/17/19EG) SOM Carrier board supports two 10/100/100Mbps Ethernet ports. First Ethernet port is supported through GEM0 interface of Zynq Ultrascale+ MPSoC (ZU11/17/19EG) PS. Ethernet PHY output signals from Board to Board connector2 is directly connected to RJ45 Magjack (J17). The Ethernet supports Speed (Yellow) and Link/Activity (Green) LED indications on RJ45 Magjack connector. This RJ45 Magjack connector(J17) is physically located at the top of the board as shown below.

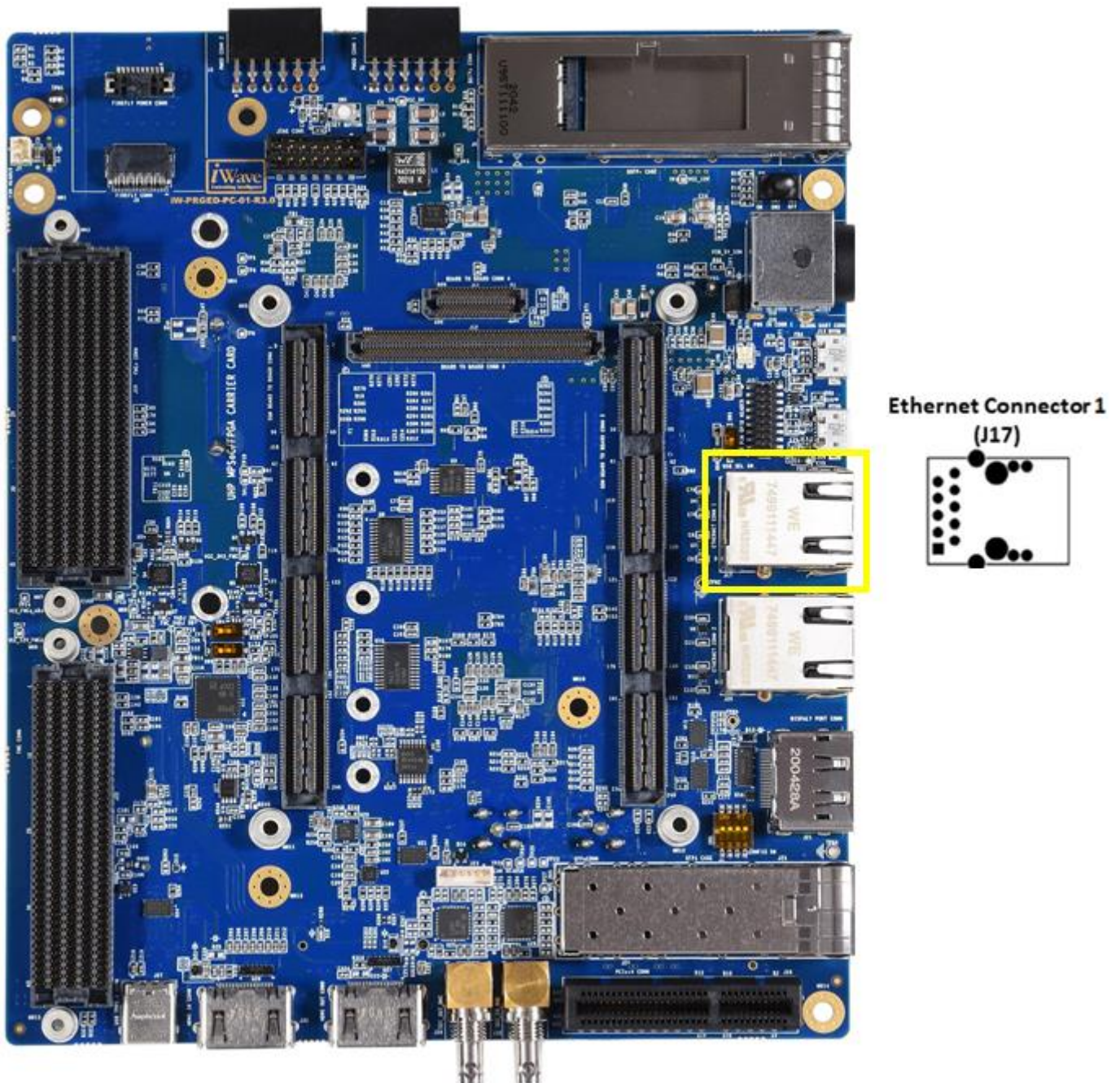

Figure 12: Gigabit Ethernet Connector1

2.4.3 Gigabit Ethernet Port2

The Zynq Ultrascale+ MPSoC (ZU11/17/19EG) SOM Carrier board supports two 10/100/1000Mbps Ethernet ports. The second Ethernet port is supported through GEM3 interface of Zynq Ultrascale+ MPSoC (ZU11/17/19EG) PS. The MAC is integrated in the Zynq-Ultrascale+ MPSoC (ZU11/17/19EG) PS and connected to the external Gigabit Ethernet PHY “AR8031” on Carrier Board through Board to Board Connector1. This PHY is interfaced with GEM3 interface of MPSoC’s PS through MIO pins and works at 1.8V IO voltage level.

The Gigabit Ethernet PHY also supports MDC, MDIO, Reset and Interrupt Signals for control. These signals are used through PL Bank EMIO pins from Board to Board Connector1 pins 124, 126, 92 & 94 respectively. Ethernet PHY output is directly connected to RJ45 Magjack (J20). Also it supports Speed (Yellow) and Link/Activity (Green) LED indications on RJ45 Magjack connector. This RJ45 Magjack connector is physically located at the top of the board as shown below.

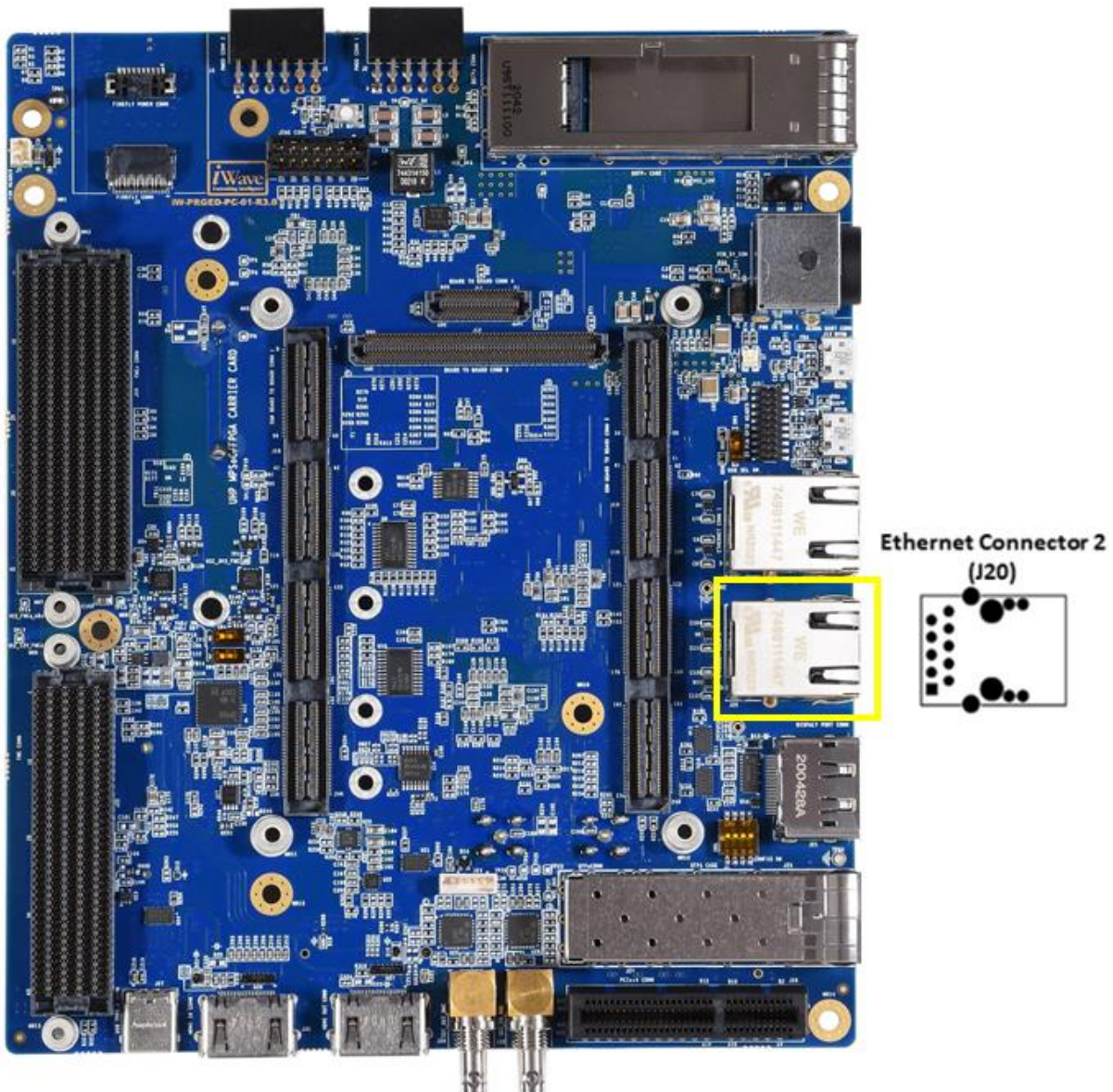

Figure 13: Gigabit Ethernet Connector2

2.4.4 USB2.0 OTG Port

The Zynq Ultrascale+ MPSoC (ZU11/17/19EG) carrier Board supports USB2.0 High Speed OTG interface through USB0 OTG Controller of Zynq Ultrascale+ MPSoC (ZU11/17/19EG) PS. This USB2.0 OTG interface is supported through USB2.0 MicroAB connector (J16). The USB PHY Transceiver output signals from Board to Board connector2 is connected to “FUSB340” USB Switch for selecting the USB2.0 OTG connection between USB2.0 MicroAB connector (J16) and USB3.0 TypeC connector (J27). The selection can be done by setting the Single bit DIP switch (SW3). If the DIP switch (SW3) is set to ON, USB2.0 OTG is connected to MicroAB connector (J16) and if the DIP switch (SW3) is set to OFF, USB2.0 OTG is connected to USB3.0 TypeC connector (J27).

The USB2.0 OTG port can be used as full functional OTG functionality which supports USB2.0 host and USB2.0 device based on USB ID pin status. The VBUS power of this USB2.0 MicroAB connector is connected through current limit power switch which can be used to switch On/Off the power based on the device or Host and also limits the current above 900mA in host mode. The USB PHY transceiver in SOM detects the USB functionality through USB ID pin (34th pin of B2B-2) and controls the power using the USB_PWR_EN pin (32nd pin of B2B-2). This USB2.0 OTG connector (J16) is physically located at the top of the board as shown below.

Note:

Connect the USB2.0 pendrive/mouse to the microAB to Host connector first, then connect the connector to the board connector(J16).

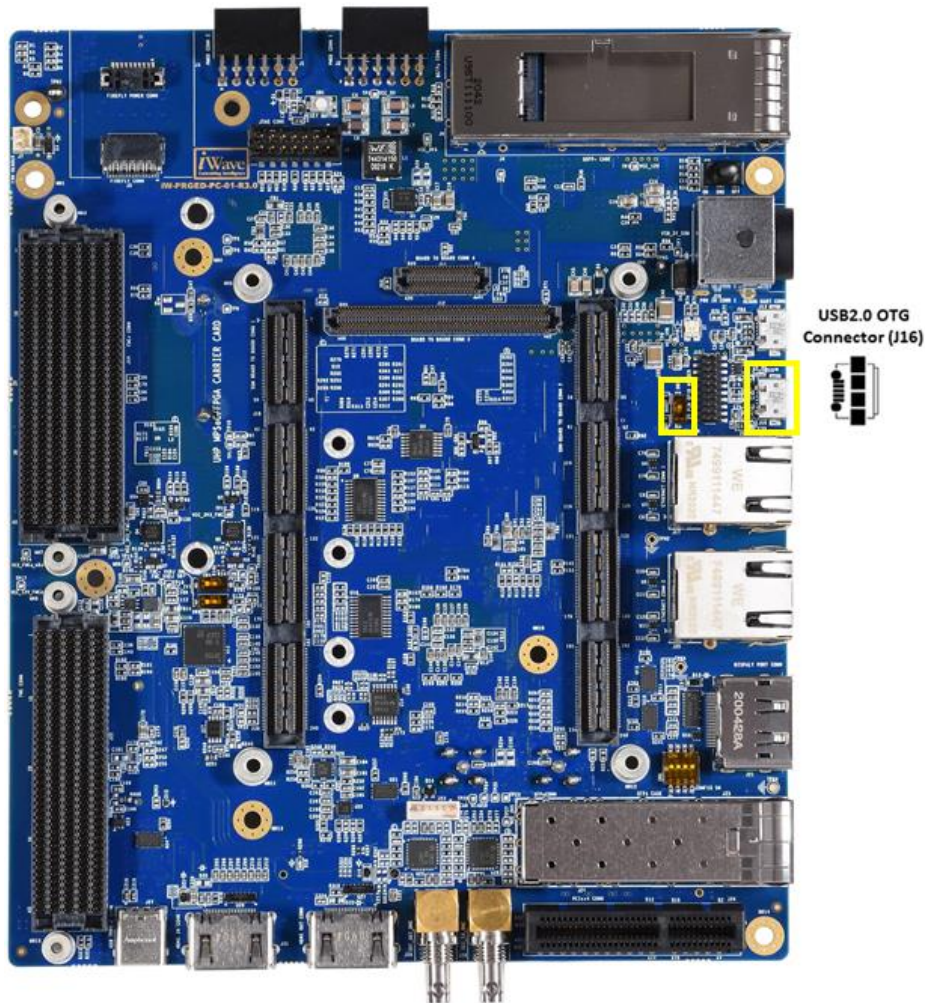

Figure 14: USB OTG Connector

2.4.5 Standard SD Port

The Zynq Ultrascale+ MPSoC (ZU11/17/19EG) Carrier Board supports one SD interface through SD1 interface of Zynq Ultrascale+ MPSoC (ZU11/17/19EG) PS. This SD1 signals from Board to Board connector2 is connected to Standard SD connector (J33) through auto-direction control memory card voltage level translator to support both 1.8V and 3.3V supported cards. It supports up to 4-Bit data transfer with card detect and write protect.

The memory card voltage level translator's voltage selection is controlled through PS GPIO (PS_MIO43_501) pin from Board to Board Connector2 pin44. If PS_MIO43_501 is set to low, then 3.3V IO level is selected for SD1 signals to SD connector. If PS_MIO43_501 is set to high, then 1.8V IO level is selected for SD1 signals to SD connector. The Standard SD connector (J33) is physically located at the bottom of the board as shown below.

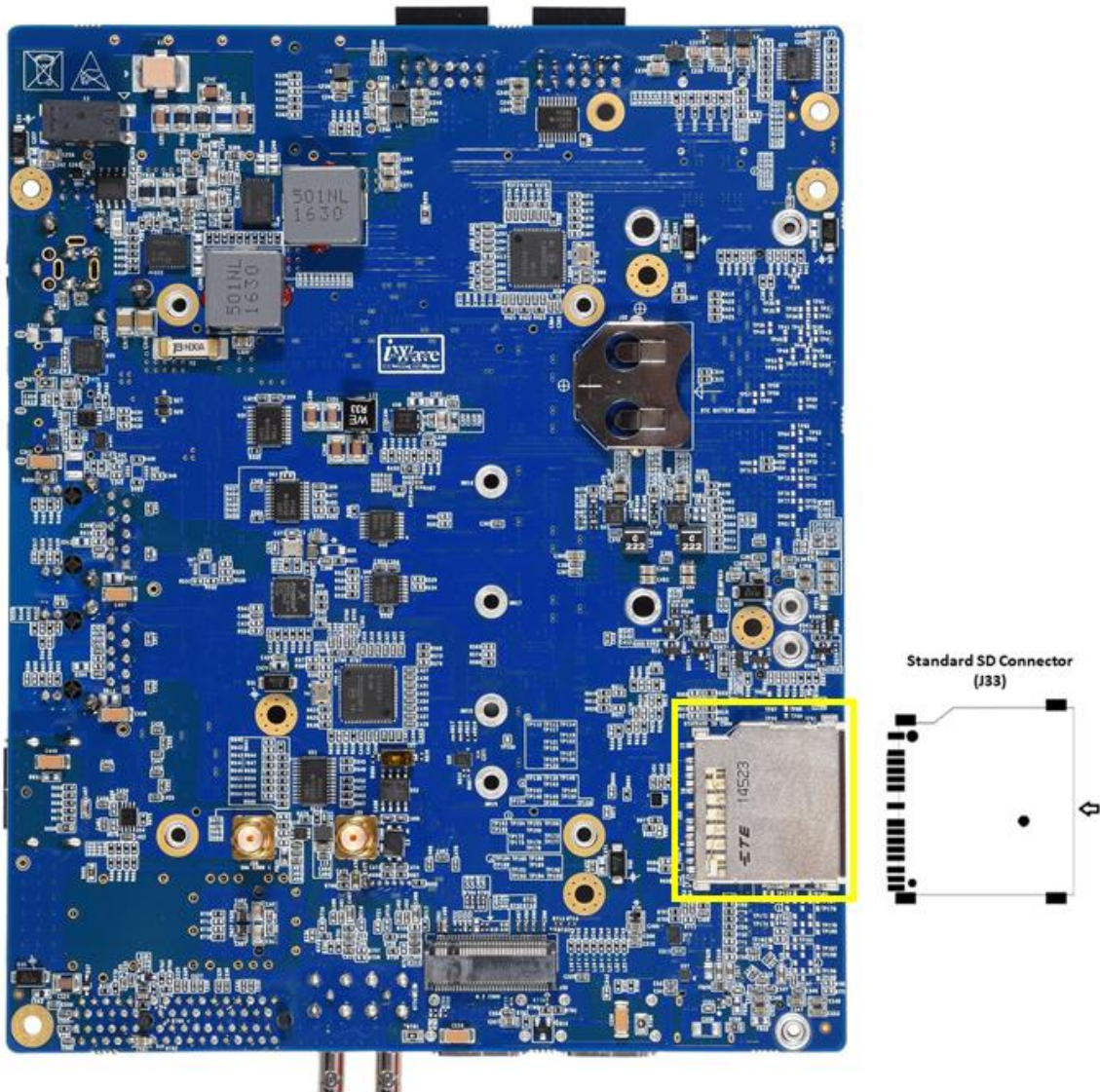

Figure 15: Standard SD Connector

2.4.6 CAN0 Header

The Zynq Ultrascale+ MPSoC (ZU11/17/19EG) Carrier board supports one CAN interface through CAN0 interface of Zynq Ultrascale+ MPSoC (ZU11/17/19EG) PS. This CAN0 signals are connected from Board to Board connector1 to CAN Bus Transceiver “MCP2562FD”. The output of CAN transceiver is connected to 6 pin custom CAN Header (J23). Standby pin of the CAN Bus transceiver is controlled through PL Bank IO (PL_B3_LVDS94_L10P) from Board to Board Connector1 Pin74. This CAN Header is physically located at the top of the board as shown below.

- Number of Pins - 6
- Connector Part - 53047-0610 from Molex
- Mating Connector - 0510210600 from Molex with crimping pins

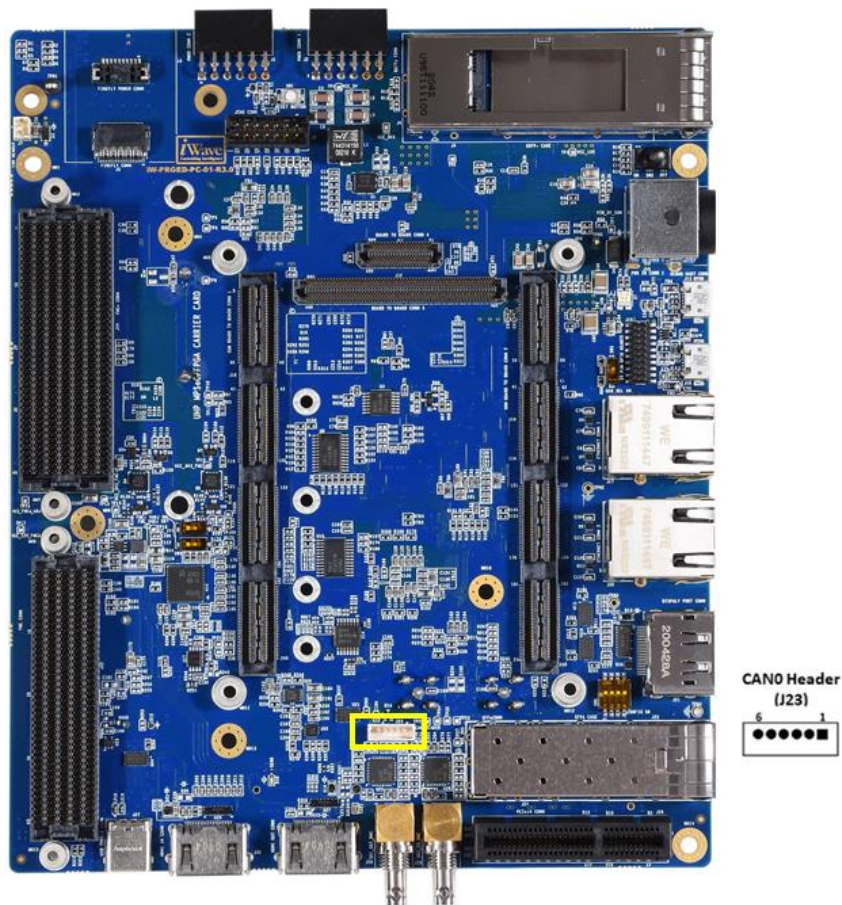

Figure 16: CAN0 Header

Table 8: CAN0 Header Pin Assignment

Pin No	Pin Name	Signal Type/ Termination	Description
1	VCC_5V	O, 5V Power	5V Supply Voltage.
2	VCC_12V	-	NC.
3	CANL	IO, DIFF	CAN Differential negative.
4	GND	Power	Ground.
5	CANH	IO, DIFF	CAN Differential positive.
6	GND	Power	Ground.

2.4.7 Debug UART

The Zynq Ultrascale+ MPSoC (ZU11/17/19EG) Carrier Board supports debug interface through UART0 interface of Zynq Ultrascale+ MPSoC (ZU11/17/19EG) PS. This UART0 signals from Board to Board Connector2 is connected to UART to USB Converter “FT232RQ”. The output of the USB converter is connected to USB MicroAB Connector (J13). This USB MicroAB Connector can be used for Debug purpose which is physically located at the top of the board as shown below.

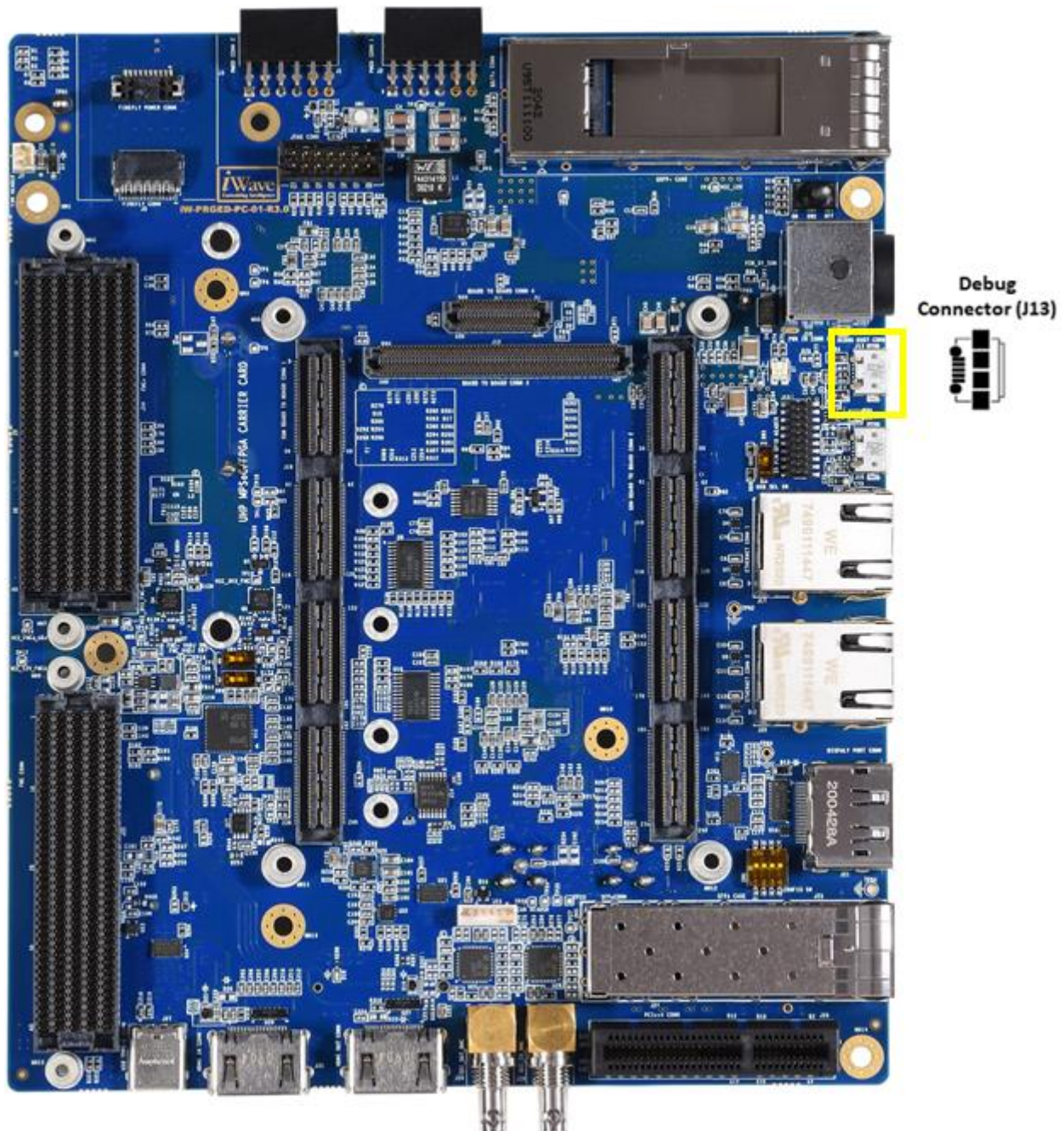

Figure 17: Debug UART Connector

2.5 PL Interface Features

The features which are supported from Zynq Ultrascale+ MPSoC (ZU11/17/19EG) PL is explained in the following section.

2.5.1 GTH High Speed Transceivers

The Zynq Ultrascale+ MPSoC (ZU11/17/19EG) Carrier board supports different high speed interfaces through 29 GTH Transceivers (12 from B2B-1, 4 from B2B-2, 8 from B2B-3, 8 from B2B-4) as mentioned below.

- SFP+ Connector (1 GTH Transceivers)
- 3G/12G SDI Video IN (1 GTH Transmitter)
- 3G/12G SDI Video OUT (1 GTH Receiver)
- HDMI IN (3 GTH Receiver)
- HDMI OUT (3 GTH Transmitter)
- SMA TX (1 GTH Transmitter)
- FMC HPC Connector (10 GTH Transceivers)
- FMC+ HPC Connector (16 GTH Transceivers)

2.5.1.1 SFP+ Connector

The Zynq Ultrascale+ MPSoC (ZU11/17/19EG) Carrier board supports one SFP+ Connector through GTH transceiver of Zynq Ultrascale+ MPSoC (ZU11/17/19EG) PL. GTH transceiver of PL Bank227 Channel2 from Board to Board Connector2 is connected to SFP+ connector. Also PS I2C0 is connected to this connector for control and configuration. All other control signals of SFP+ connector is connected from IO Expander. This SFP+ connector with dust case (J25) is physically located at the top of the board as shown below.

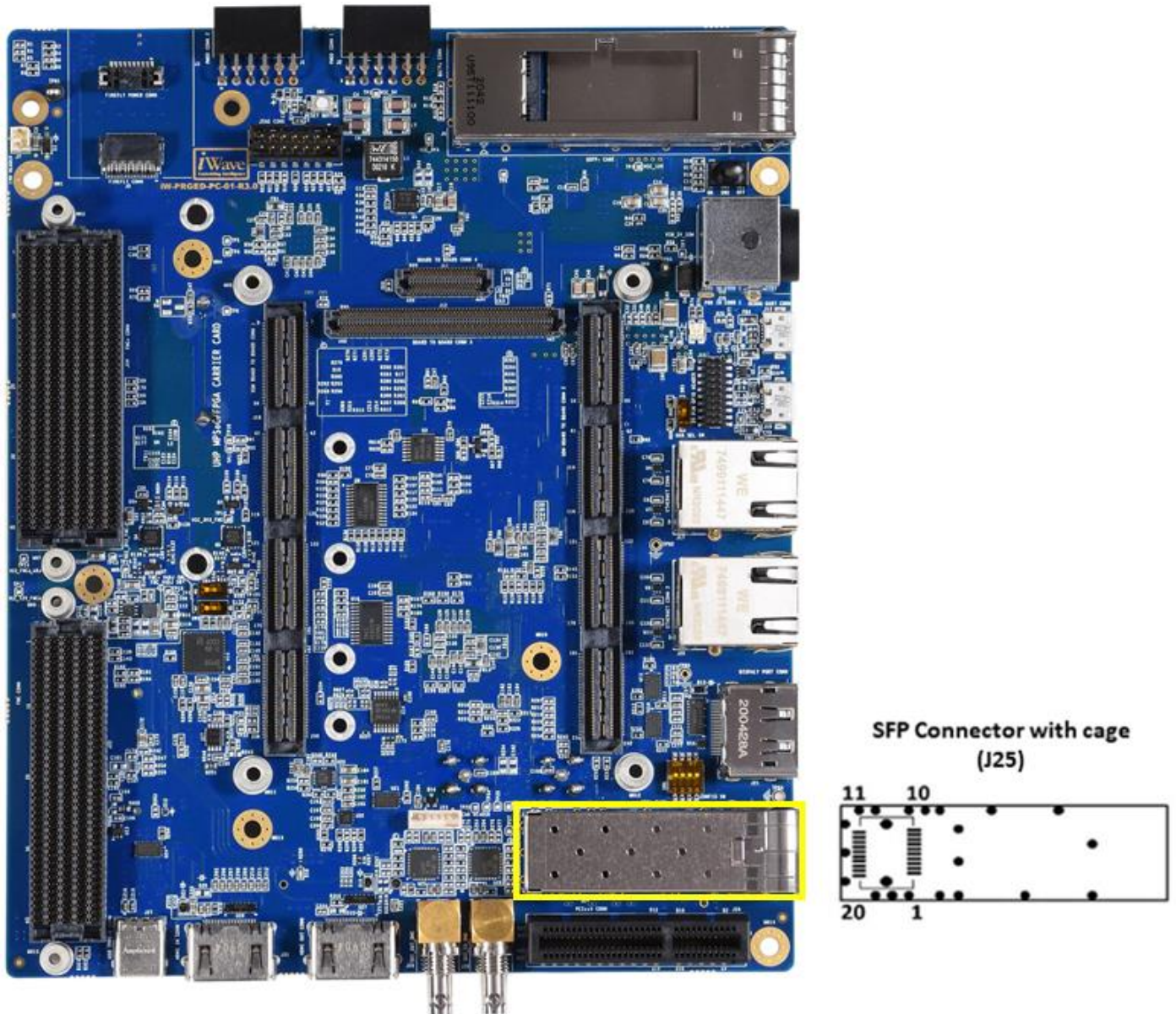

Figure 18: SFP+ Connector with Cage

Table 9: SFP+ Connector Pin Assignment

Pin No	Pin Name	Signal Name	Signal Type/ Termination	Description
1	VEET1	GND	Power	Ground.
2	TFAULT	IOEXP_P00_SFP_TFAULT	I, LVTTTL/ 4.7K PU	Module Transmitter Fault. This Pin is connected to IO Expander1 Port 0 for software access if required.
3	TDIS	IOEXP_P05_SFP_TDIS	O, LVTTTL/ 4.7K PD	Transmitter Disable. This Pin is connected to IO Expander1 Port 5 for software control if required.
4	SDA	I2C0_SD2_SDA	IO, 3.3V CMOS	I2C Data. This Pin is connected from 9th pin of I2C Bus switch (U29).
5	SCL	I2C0_SD2_SCL	O, 3.3V CMOS	I2C Clock. This Pin is connected from 10th pin of I2C Bus switch (U29).
6	MOD_ABS	IOEXP_P02_SFP_MOD_ABS	I, 3.3V CMOS/ 4.7K PU	Module Definition. This Pin is connected to IO Expander1 Port 2 for software access if required.
7	RS0	IOEXP_P04_SFP_RS0	O, 3.3V CMOS/ 4.7K PU	Rate select 0. This Pin is connected to IO Expander1 Port 4 for software control if required.
8	RX_LOS	IOEXP_P01_SFP_RX_LOS	I, 3.3V CMOS/ 4.7K PU	Receiver loss of signal indication. This Pin is connected to IO Expander1 Port 1 for software access if required.
9	RS1	IOEXP_P03_SFP_RS1	O, 3.3V CMOS/ 4.7K PU	Rate select 1. This Pin is connected to IO Expander1 Port 3 for software control if required.
10	VEER1	GND	Power	Ground.
11	VEER2	GND	Power	Ground.
12	RD-	GTHRXP2_227	I, DIFF	SFP+ Receiver Data Negative
13	RD+	GTHRXP2_227	I, DIFF	SFP+ Receiver Data Positive
14	VEER3	GND	Power	Ground.
15	VCCR	VCC_3V3	O, 3.3V Power	3.3V Receiver Supply Voltage
16	VCCT	VCC_3V3	O, 3.3V Power	3.3V Transmitter Supply Voltage
17	VEET2	GND	Power	Ground.
18	TD+	GTHTXP2_227	O, DIFF	SFP+ Transmit Data Positive
19	TD-	GTHTXN2_227	O, DIFF	SFP+ Transmit Data Negative
20	VEET3	GND	Power	Ground.

2.5.1.2 SDI Video IN

The Zynq Ultrascale+ MPSoC (ZU11/17/19EG) Carrier board supports one 3G/12G SDI Video IN interface through HD BNC connector (J29). The Video input signals from HD BNC Connector is directly connected to Adaptive Cable Equalizer chip and then connected to PL Bank227 Channel3 GTH receiver of Zynq Ultrascale+ MPSoC through Board to Board connector2.

The Zynq Ultrascale+ MPSoC (ZU11/17/19EG) Carrier board supports Video Input Lock status LED (D17) for presence and absence of the Video Input signal on HD BNC connector (J29). This LED will glow when the Video Input signal is detected on HD BNC connector (J29). Also PS I2C0 is connected to Adaptive Cable Equalizer chip for control and configuration with I2C address 0x2D. SDI Video IN HD BNC connector (J29) is physically located at the top of the board as shown below.

Note: By default, 12G Adaptive Cable Equalizer chip “LMH1297” is supported on the board. To support 3G Adaptive Cable Equalizer chip “LMH0397”, contact iWave.

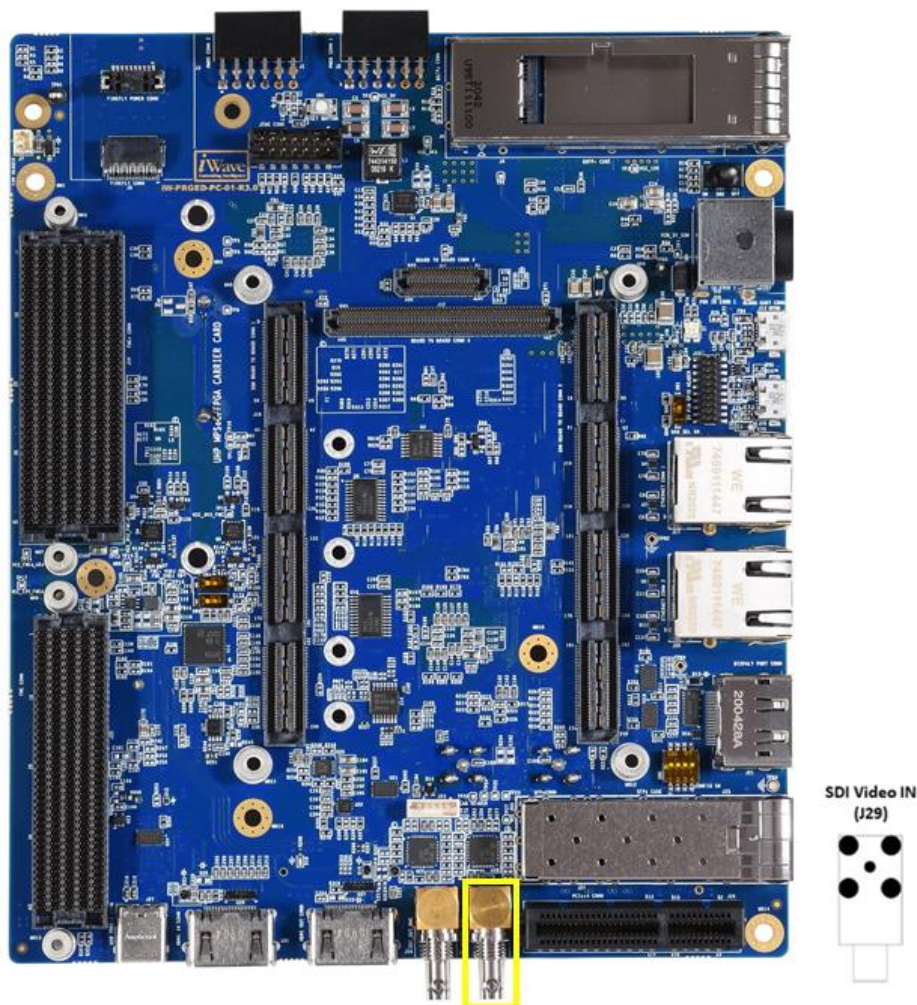

Figure 19: SDI Video IN HD BNC Connector

2.5.1.3 SDI Video Out

The Zynq Ultrascale+ MPSoC (ZU11/17/19EG) Carrier board supports one 3G/12G SDI Video OUT interface through HD BNC connector (J28). Zynq Ultrascale+ MPSoC's PL Bank227 Channel3 GTH transmitter from Board to Board connector2 is directly connected to Cable Driver chip and then connected to HD BNC Connector (J28) for Video out.

The Zynq Ultrascale+ MPSoC (ZU11/17/19EG) Carrier board supports Video Output Lock status LED (D16). This LED will glow when the video signal from MPSoC GTH transmitter is detected on Cable Driver chip. Also PS I2C0 is connected to Cable Driver chip for control and configuration with I2C address 0x30. SDI Video OUT HD BNC connector (J28) is physically located at the top of the board as shown below.

Note: By default, 12G Adaptive Cable Equalizer chip "LMH1297" is supported on the board. To support 3G Adaptive Cable Equalizer chip "LMH0397", contact iWave.

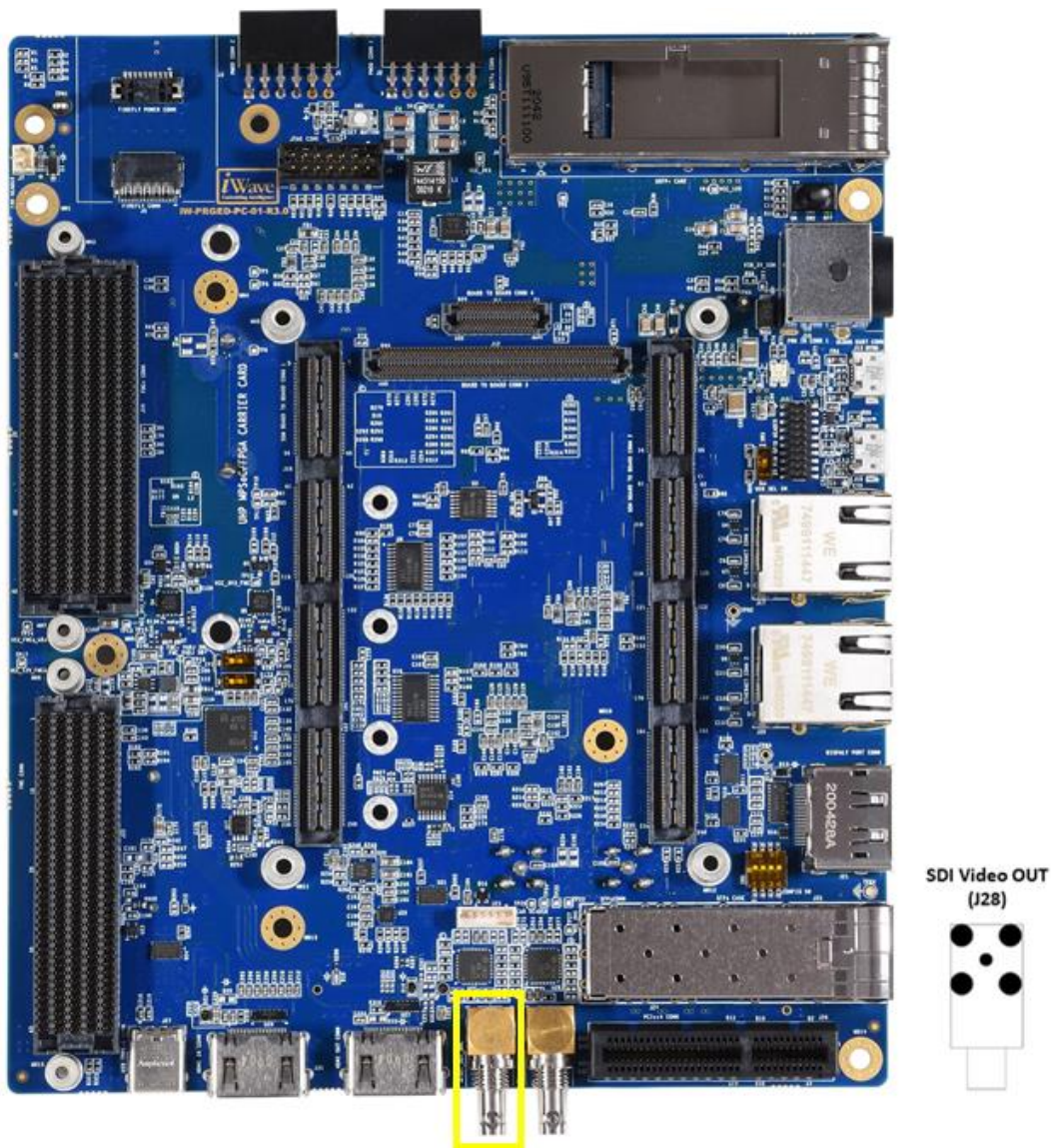

Figure 20: SDI Video OUT HD BNC Connector

2.5.1.4 HDMI IN

The Zynq Ultrascale+ MPSoC (ZU11/17/19EG) Carrier board supports one HDMI IN interface through HDMI connector (J30). Zynq Ultrascale+ MPSoC's PL Bank226 Channel0 to Channel2 GTH receiver from Board to Board connector1 is directly connected from HDMI IN Connector (J30) for HDMI IN support. HDMI-IN cable detect feature is supported through PL Bank IO "PL_E15_LVDS68_L14P_GC" from Board to Board Connector2 pin110. HDMI IN connector (J30) is physically located at the top of the board as shown below.

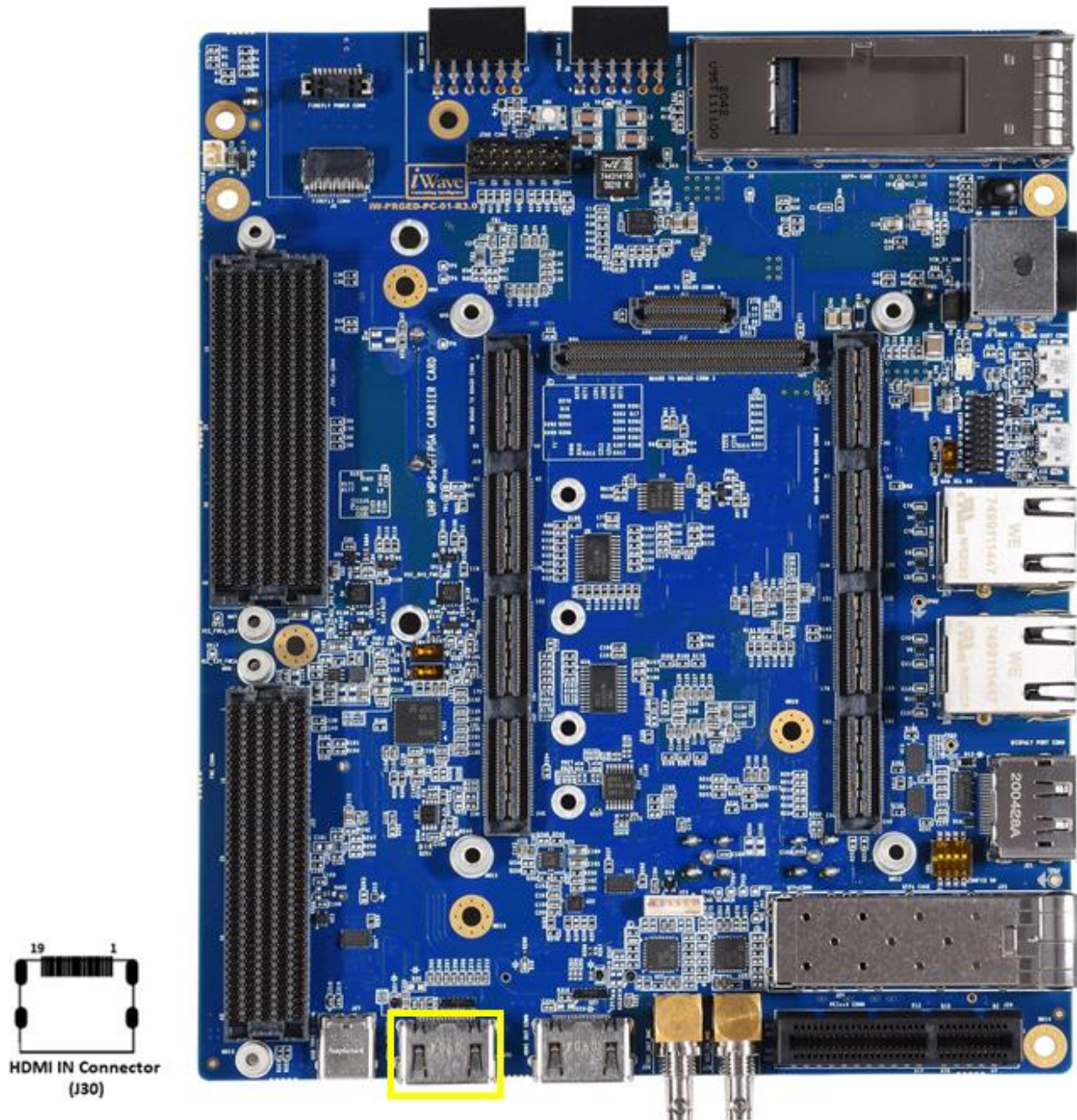

Figure 21 HDMI IN Connector

2.5.1.5 HDMI OUT

The Zynq Ultrascale+ MPSoC (ZU11/17/19EG) Carrier board supports one HDMI OUT interface through HDMI connector (J31). Zynq Ultrascale+ MPSoC's PL Bank226 Channel0 to Channel2 GTH transmitter from Board to Board connector1 is directly connected to HDMI Remitter chip (SN65DP159RGZR) and then connected to HDMI OUT Connector (J31) for HDMI Video out.

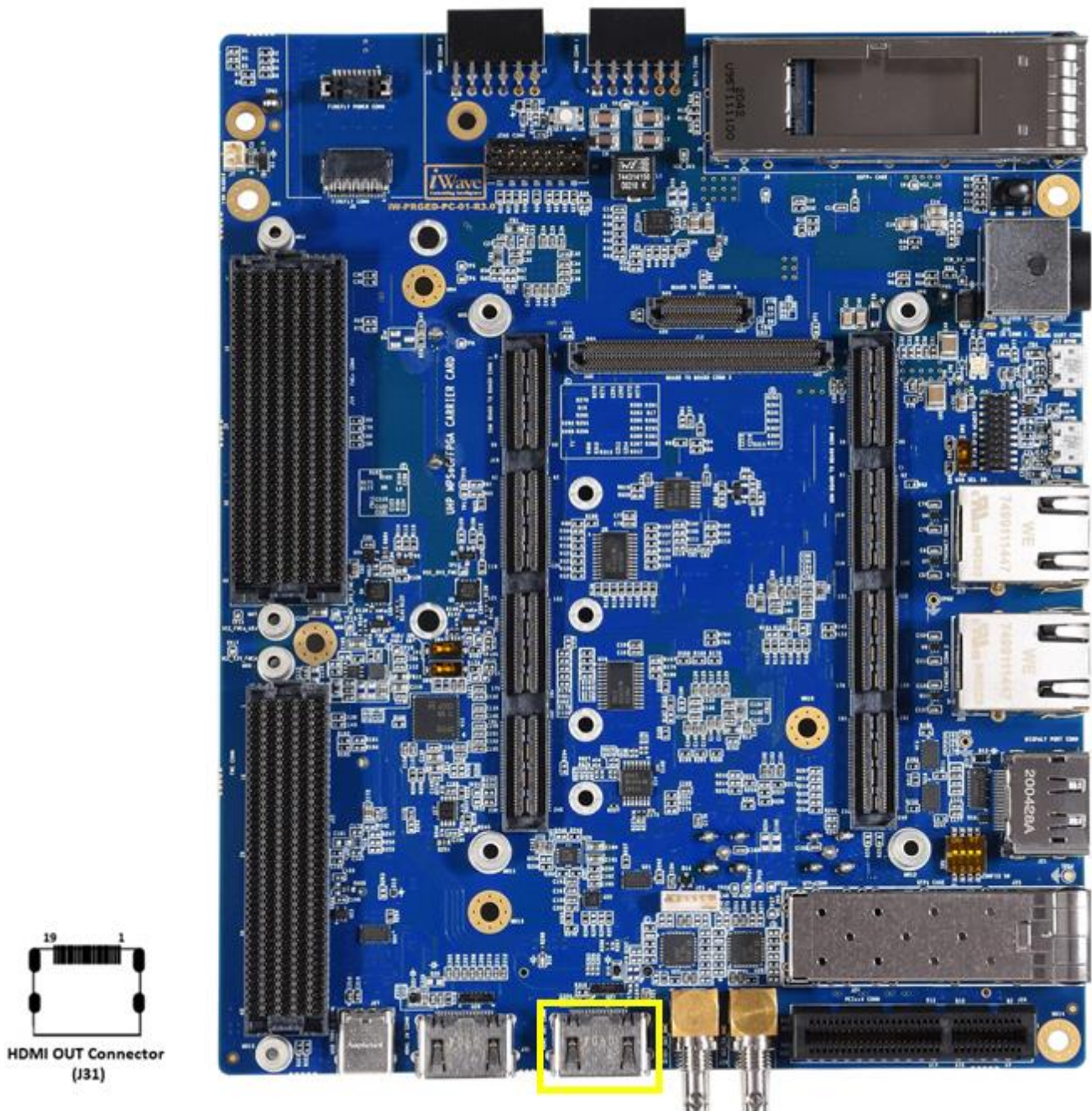

Figure 22 HDMI OUT Connector

2.5.2 GTY High Speed Transceivers

The Zynq Ultrascale+ MPSoC (ZU11/17/19EG) Carrier board supports different high speed interfaces through 16 GTY Transceivers (16 from B2B-3) as mentioned below.

- QSFP28/QSFP+/QSFP Connector (4 GTY Transceivers)
- FireFly Connector (4 GTY Transceivers)
- FMC+ HPC Connector (8 GTY Transceivers)

2.5.2.1 QSFP28/QSFP+/QSFP Connector

The Zynq Ultrascale+ MPSoC (ZU11/17/19EG) Carrier board supports one QSFP28/QSFP+/QSFP Connector through GTY transceiver of Zynq Ultrascale+ MPSoC (ZU11/17/19EG) PL. GTY transceiver of PL Bank131 Channel0 to Channel3 from Board to Board Connector3 is connected to QSFP+ connector. Also PS I2C0 is connected to this connector for control and configuration. All other control signals of QSFP+ connector is connected from IO Expander. This QSFP+ connector with dust case (J4) is physically located at the top of the board as shown below.

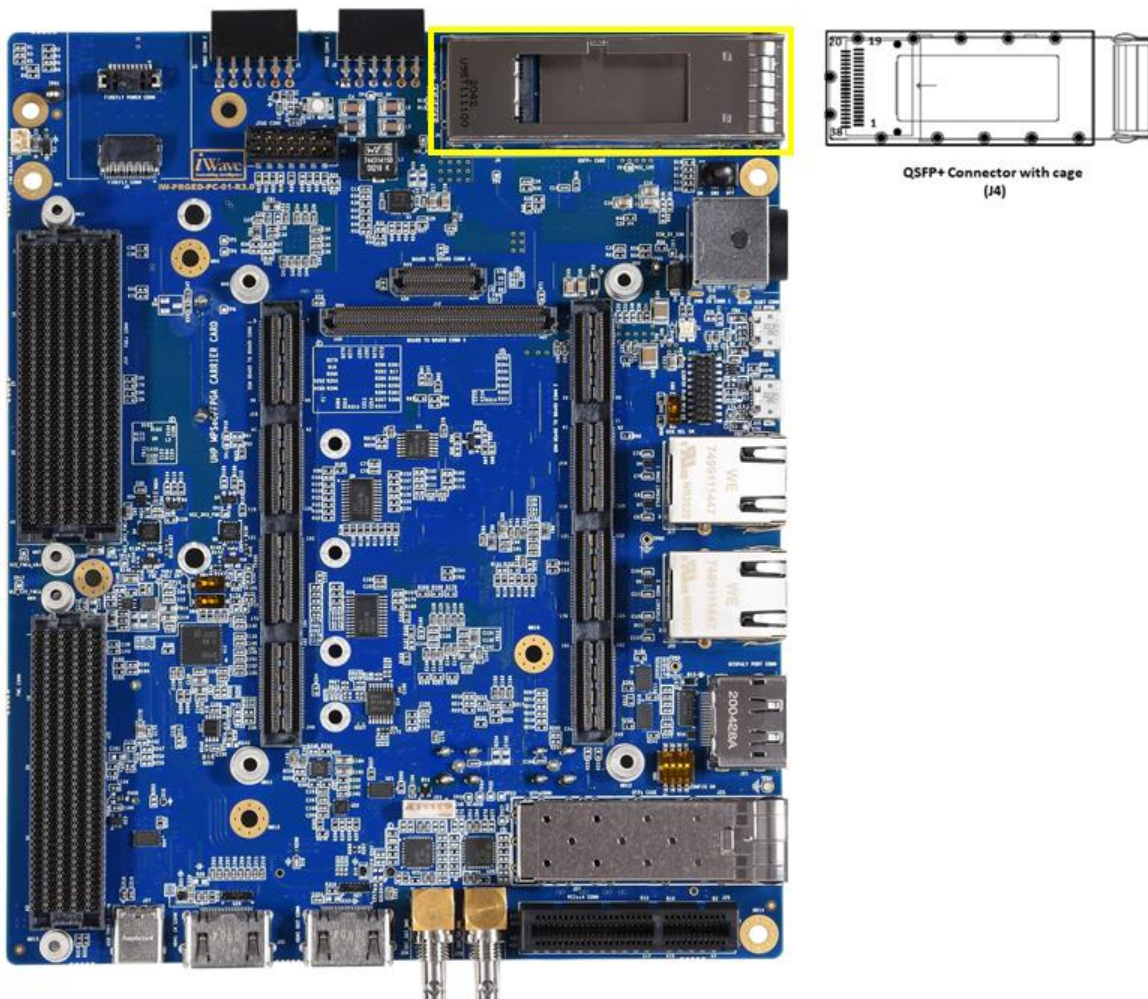

Figure 23 QSFP28/QSFP+/QSFP+ Connector with Cage

Table 10 QSFP28/QSFP+/QSFP Connector Pin Out

Pin No	Pin Name	Signal Name	Signal Type / Termination	Description
1	GND1	GND	Power	Ground.
2	Tx2n	GTYTXN1_131	O, DIFF	QSFP+ Transmit2 Data Negative
3	Tx2p	GTYTXP1_131	O, DIFF	QSFP+ Transmit2 Data Positive.
4	GND2	GND	Power	Ground.
5	Tx4n	GTYTXN3_131	O, DIFF	QSFP+ Transmit4 Data Negative
6	Tx4p	GTYTXP3_131	O, DIFF	QSFP+ Transmit4 Data Positive.
7	GND3	GND	Power	Ground.
8	ModSelL	IOEXP_P00_Q_MODESEL	I, 3.3V CMOS/ 4.7K PD	Module select. This Pin is connected to IO Expander2 Port 0 for software access if required
9	ResetL	IOEXP_P01_Q_RESETL	I, 3.3V CMOS/ 4.7K PU	Module reset. This Pin is connected to IO Expander2 Port 1 for software access if required
10	Vcc Rx	VCCR_X_3V3	O, 3.3V Power	3.3V Receiver Supply Voltage
11	SCL	I2C0_SD0_SDA	O, 3.3V CMOS	I2C Clock. This Pin is connected from 4th pin of I2C Bus switch (U29).
12	SDA	I2C0_SD0_SCL	IO, 3.3V CMOS	I2C Data. This Pin is connected from 5th pin of I2C Bus switch (U29).
13	GND4	GND	Power	Ground.
14	Rx3p	GTYRX_P2_131	I, DIFF	QSFP+ Receiver3 Data Positive
15	Rx3n	GTYRX_N2_131	I, DIFF	QSFP+ Receiver3 Data Negative
16	GND5	GND	Power	Ground.
17	Rx1p	GTYRX_P0_131	I, DIFF	QSFP+ Receiver1 Data Positive
18	Rx1n	GTYRX_N0_131	I, DIFF	QSFP+ Receiver1 Data Negative
19	GND6	GND	Power	Ground.
20	GND7	GND	Power	Ground.
21	Rx2n	GTYRX_N1_131	I, DIFF	QSFP+ Receiver2 Data Negative
22	Rx2p	GTYRX_P1_131	I, DIFF	QSFP+ Receiver2 Data Positive
23	GND8	GND	Power	Ground.
24	Rx4n	GTYRX_N3_131	I, DIFF	QSFP+ Receiver4 Data Negative
25	Rx4p	GTYRX_P3_131	I, DIFF	QSFP+ Receiver4 Data Positive
26	GND9	GND	Power	Ground.
27	ModPrsL	IOEXP_P04_Q_MODPRSL	I, 3.3V CMOS/ 4.7K PU	Module present. This Pin is connected to IO Expander2 Port 4 for software access if required
28	IntL	IOEXP_P03_Q_INTL	I, 3.3V CMOS/ 4.7K PU	Module Interrupt. This Pin is connected to IO Expander2 Port 3 for software access if required
29	Vcc Tx	VCCTX_X_3V3	O, 3.3V Power	3.3V Transmit Supply Voltage

Pin No	Pin Name	Signal Name	Signal Type / Termination	Description
30	Vcc1	VCC1_3V3	O, 3.3V Power	3.3V Supply Voltage
31	LPMODE	IOEXP_P02_Q_LPMODE	I, 3.3V CMOS/ 4.7K PD	Module Low power mode. This Pin is connected to IO Expander2 Port 2 for software access if required
32	GND10	GND	Power	Ground.
33	Tx3p	GTYTXP2_131	O, DIFF	QSFP+ Transmit3 Data Positive.
34	Tx3n	GTYTXN2_131	O, DIFF	QSFP+ Transmit3 Data Negative.
35	GND11	GND	Power	Ground.
36	Tx1p	GTYTXP0_131	O, DIFF	QSFP+ Transmit1 Data Positive
37	Tx1n	GTYTXN0_131	O, DIFF	QSFP+ Transmit1 Data Negative.
38	GND12	GND	Power	Ground.

2.5.2.2 FireFly Connector

The Zynq Ultrascale+ MPSoC (ZU11/17/19EG) Carrier board supports one FireFly Connector through GTY transceiver of Zynq Ultrascale+ MPSoC (ZU11/17/19EG) PL. GTY transceiver of PL Bank128 Channel0 to Channel3 from Board to Board Connector3 is connected to FireFly data connector(J5). Also PS I2C0 is connected to this connector for control and configuration. All other control signals of FireFly connector is connected from IO Expander. And FireFly module power is supplied from FireFly power connector (J3). This FireFly data with power connector (J5) is physically located at the top of the board as shown below.

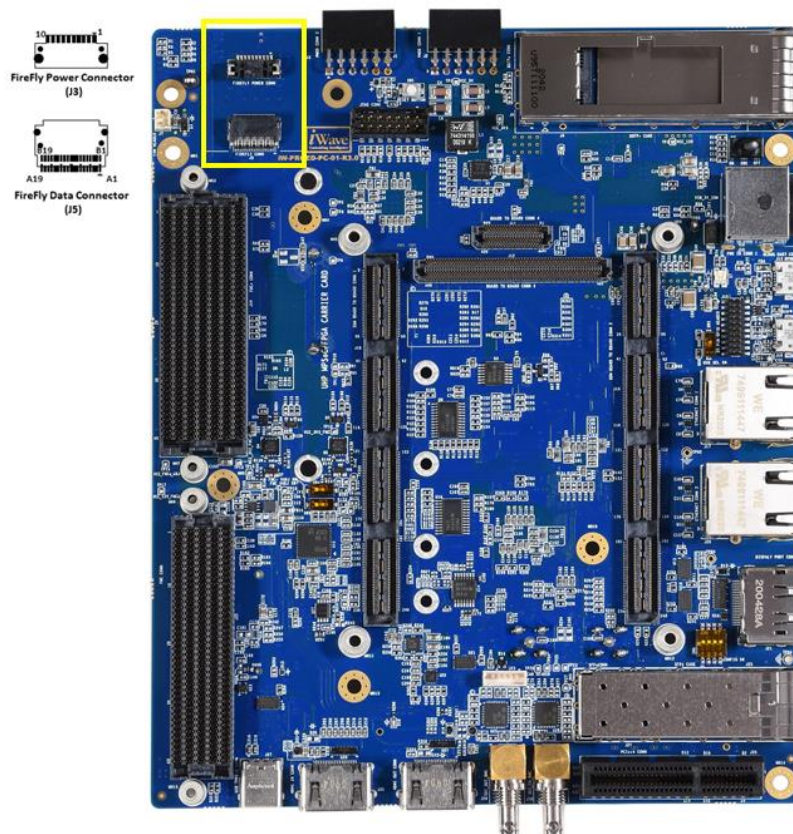

Figure 24 FireFly Connector

Table 11 FireFly Data Connector Pin Out

Pin No	Pin Name	Signal Name	Signal Type / Termination	Description
A1	GND_1	GND	Power	Ground.
A2	TX1N	GTYTXN0_128	O, DIFF	FireFly Transmit1 Data Negative
A3	TX1P	GTYTXP0_128	O, DIFF	FireFly Transmit1 Data Positive.
A4	GND_2	GND	Power	Ground.
A5	TX3N	GTYTXN1_128	O, DIFF	FireFly Transmit3 Data Negative
A6	TX3P	GTYTXP1_128	O, DIFF	FireFly Transmit3 Data Positive.
A7	GND_3	GND	Power	Ground.
A8	RSVD_1	NA	NA	NC
A9	RSVD_2	NA	NA	NC
A10	RSVD_3	NA	NA	NC
A11	RSVD_4	NA	NA	NC
A12	RSVD_5	NA	NA	NC
A13	GND_4	GND	Power	Ground.
A14	RX4P	GTYRXP3_128	I, DIFF	FireFly Receiver4 Data Positive
A15	RX4N	GTYRXN3_128	I, DIFF	FireFly Receiver4 Data Negative
A16	GND_5	GND	Power	Ground.
A17	RX2P	GTYRXP2_128	c	FireFly Receiver2 Data Positive
A18	RX2N	GTYRXN2_128	ccc	FireFly Receiver2 Data Negative
A19	GND_6	GND	Power	Ground.
B1	GND_7	GND	Power	Ground.
B2	TX2N	GTYTXN2_128	O, DIFF	FireFly Transmit2 Data Negative
B3	TX2P	GTYTXP2_128	O, DIFF	FireFly Transmit2 Data Positive.
B4	GND_8	GND	Power	Ground.
B5	TX4N	GTYTXN3_128	O, DIFF	FireFly Transmit4 Data Negative
B6	TX4P	GTYTXP3_128	O, DIFF	FireFly Transmit4 Data Positive.
B7	GND_9	GND	Power	Ground.
B8	RSVD_6	NA	NA	NC
B9	RSVD_7	NA	NA	NC
B10	RSVD_8	NA	NA	NC
B11	RSVD_9	NA	NA	NC
B12	RSVD_10	NA	NA	NC
B13	GND_10	GND	Power	Ground.
B14	RX3P	GTYRXP1_128	I, DIFF	FireFly Receiver3 Data Positive
B15	RX3N	GTYRXN1_128	I, DIFF	FireFly Receiver3 Data Negative
B16	GND_11	GND	Power	Ground.
B17	RX1P	GTYRXPO_128	I, DIFF	FireFly Receiver1 Data Positive
B18	RX1N	GTYRXNO_128	I, DIFF	FireFly Receiver1 Data Negative
B19	GND_12	GND	Power	Ground.

Table 12 FireFly Power Connector Pin Out

Pin No	Pin Name	Signal Name	Signal Type / Termination	Description
1	VCC_TX	VCCTX_F_3V3	O, 3.3V Power	3.3V Transmit Supply Voltage
2	GND_14	GND	Power	Ground
3	MODPRS	IOEXP_P10_F_MODPRS	I, 3.3V CMOS/ 4.7K PU	FireFly Module Present. This Pin is connected to IO Expander2 Port 10 for software access if required
4	MODSEL	IOEXP_P06_F_MODSEL	I, 3.3V CMOS/ 4.7K PU	FireFly Module Select. This Pin is connected to IO Expander2 Port 6 for software access if required
5	INTL	IOEXP_P07_F_INTL	I, 3.3V CMOS/ 4.7K PU	FireFly Module Interrupt. This Pin is connected to IO Expander2 Port 7 for software access if required
6	RESETL	IOEXP_P05_F_RESETL	I, 3.3V CMOS/ 4.7K PU	FireFly Module Reset. This Pin is connected to IO Expander2 Port 5 for software access if required
7	SDA	I2C0_SD1_SDA	IO, 3.3V CMOS	I2C Data. This Pin is connected from 6th pin of I2C Bus switch (U29).
8	SCL	I2C0_SD1_SCL	O, 3.3V CMOS	I2C Clock. This Pin is connected from 7th pin of I2C Bus switch (U29).
9	VCC_1.8V	VCC_F_1V8	O, 3.3V Power	1.8 V supply
10	VCC_RX	VCCR_X_F_3V3	O, 3.3V Power	3.3V Receive Supply Voltage

2.5.3 Pmod Host Port Connectors

Pmod interface or Peripheral Module interface is a standard defined by Digilent Inc. The Pmod interface is used to connect low frequency, low I/O pin count peripheral modules to host controller boards. There are twelve pins of the interface defined, encompassing SPI, I²C, UART, I2S and GPIO protocols.

The Zynq Ultrascale+ MPSoC (ZU11/17/19EG) Carrier board supports two 12-pin Pmod host port connectors for plugging Pmod modules. Since Pmod interface specification requires 3.3V IO level, the signals from Board to Board connector is connected to Pmod Connectors through Voltage level translator. Pmod Host port connector1 (J2) and Connector2 (J1) are physically located at the top of the board as shown below.

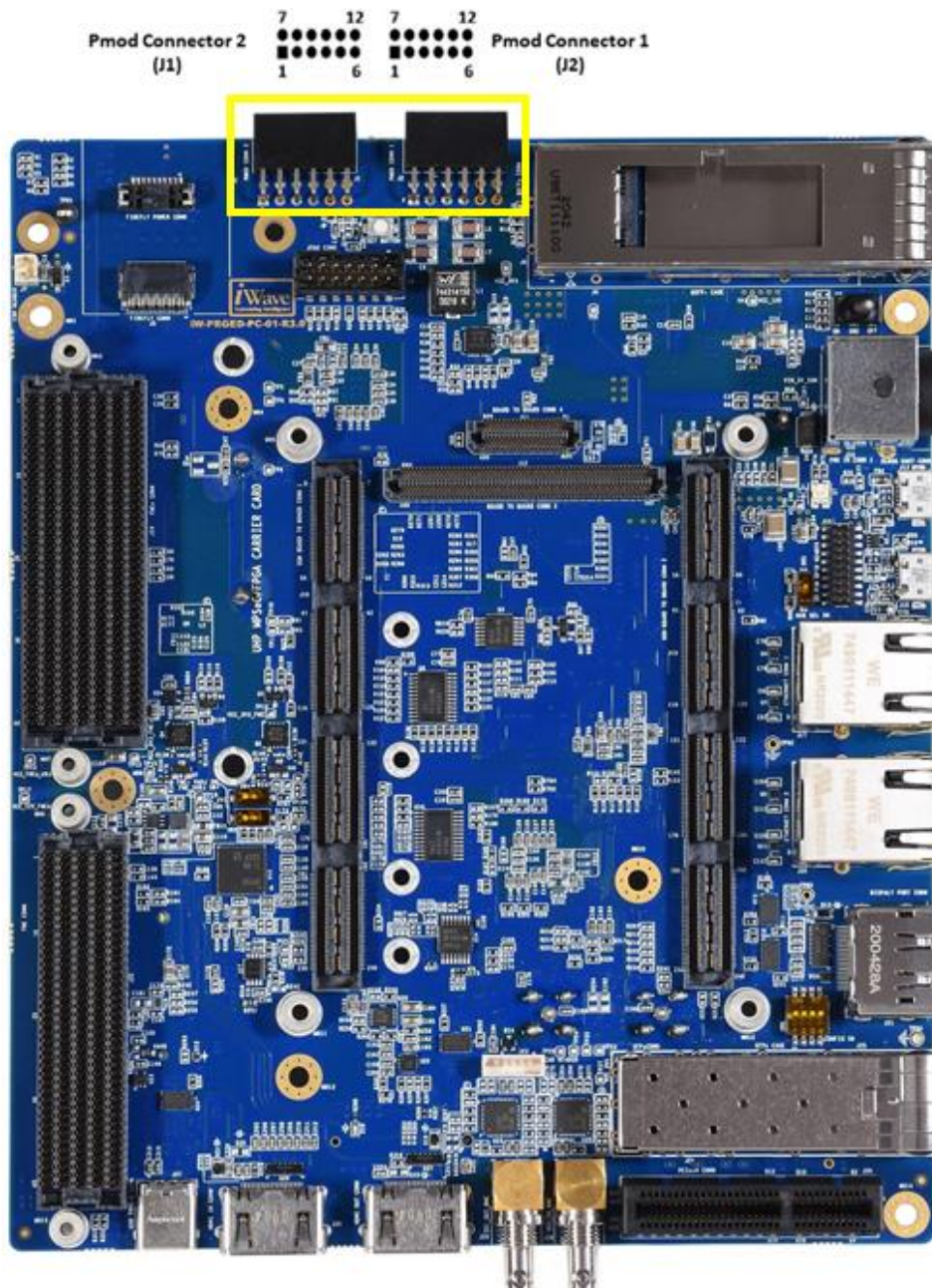

Figure 25: Pmod Host Port Connectors

Table 13: Pmod Connector1 Pin Assignment

Pin No	Signal Name	Signal Type/ Termination	Description
1	PL_B16_LVDS68_L20N	IO, 3V3 LVCMOS	General purpose Input Output.
2	PL_A18_LVDS68_L24N	IO, 3V3 LVCMOS	General purpose Input Output.
3	PL_A13_LVDS68_L17N	IO, 3V3 LVCMOS	General purpose Input Output.
4	PL_B15_LVDS68_L18N	IO, 3V3 LVCMOS	General purpose Input Output.
5	GND	Power	Ground.
6	VCC_3V3	O, 3.3V Power	3V3 Supply Voltage.
7	PL_C16_LVDS68_L20P	IO, 3V3 LVCMOS	General purpose Input Output.
8	PL_B18_LVDS68_L24P	IO, 3V3 LVCMOS	General purpose Input Output.
9	PL_A14_LVDS68_L17P	IO, 3V3 LVCMOS	General purpose Input Output.
10	PL_C15_LVDS68_L18P	IO, 3V3 LVCMOS	General purpose Input Output.
11	GND	Power	Ground.
12	VCC_3V3	O, 3.3V Power	3V3 Supply Voltage.

Table 14: Pmod Connector2 Pin Assignment

Pin No	Signal Name	Signal Type/ Termination	Description
1	PL_D17_LVDS68_L21N	IO, 3V3 LVCMOS	General purpose Input Output.
2	PL_L15_LVDS68_L4N_DBC	IO, 3V3 LVCMOS	General purpose Input Output.
3	PL_A17_LVDS68_L22N_DBC	IO, 3V3 LVCMOS	General purpose Input Output.
4	PL_K17_LVDS68_L6N	IO, 3V3 LVCMOS	General purpose Input Output.
5	GND	Power	Ground.
6	VCC_3V3	O, 3.3V Power	3V3 Supply Voltage.
7	PL_M15_LVDS68_L4P_DBC	IO, 3V3 LVCMOS	General purpose Input Output.
8	PL_E17_LVDS68_L21P	IO, 3V3 LVCMOS	General purpose Input Output.
9	PL_B17_LVDS68_L22P_DBC	IO, 3V3 LVCMOS	General purpose Input Output.
10	PL_L17_LVDS68_L6P	IO, 3V3 LVCMOS	General purpose Input Output.
11	GND	Power	Ground.
12	VCC_3V3	O, 3.3V Power	3V3 Supply Voltage.

2.5.4 SMA Connectors

The Zynq Ultrascale+ MPSoC (ZU11/17/19EG) Carrier board supports two SMA Connectors through GTH transceiver of Zynq Ultrascale+ MPSoC (ZU11/17/19EG) PL. GTH transceiver of PL Bank226 Channel3-TXP from Board to Board Connector1 is connected to SMA Connector (J34) and and Channel3-TXN from Board to Board Connector1 is connected to SMA Connector (J35) . SMA connectors (J34 & J35) are physically located at the bottom of the board as shown below.

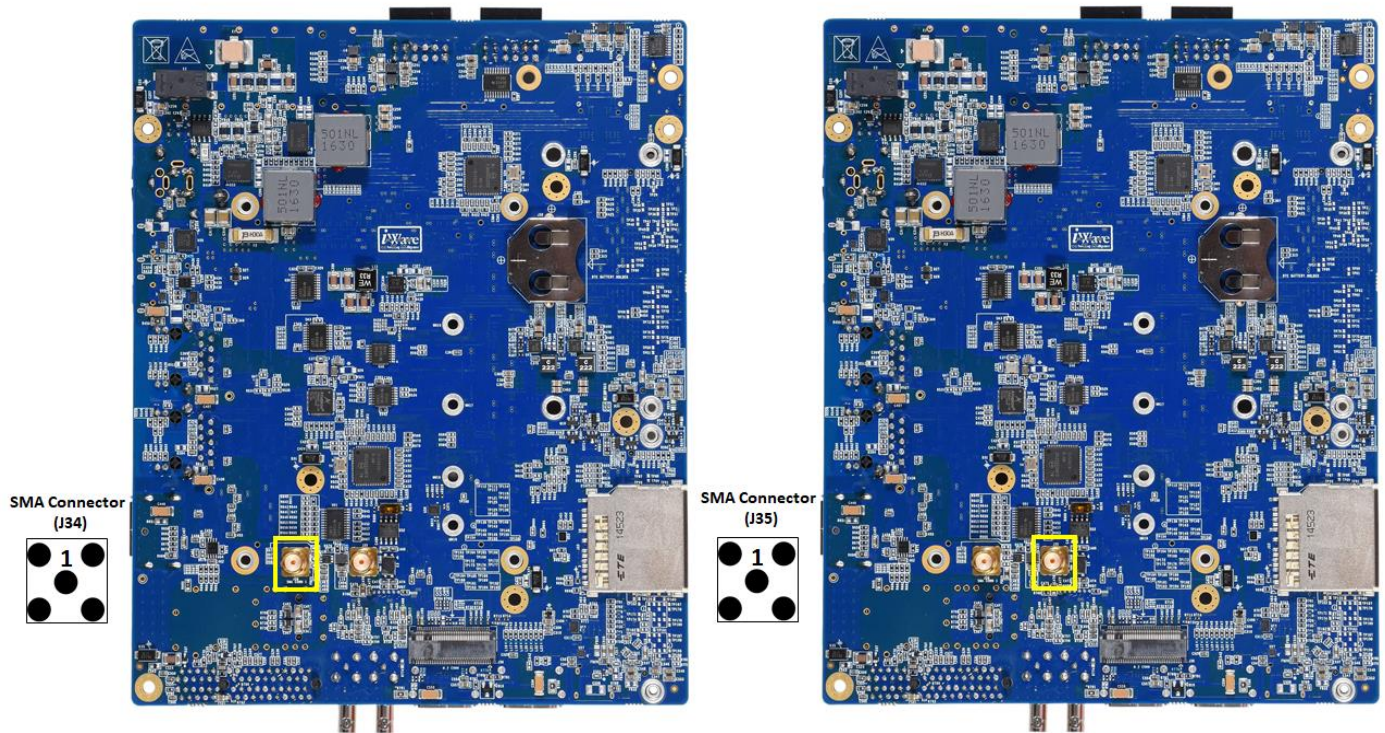

Figure 26: SMA Connectors

Table 15: SMA Connector Pin Assignment

Pin No	Signal Name	Signal Type/ Termination	Description
J34.1	GTHTXP3_226	O, DIFF	GTH Bank226 channel3 High speed differential transmitter positive.
J35.1	GTHTXN3_226	O, DIFF	GTH Bank226 channel3 High speed differential transmitter negative.

2.5.5 FMC HPC Connector

The Zynq Ultrascale+ MPSoC (ZU11/17/19EG) Carrier board supports one 400Pin Standard FMC HPC connector to support standard ANSI/VITA 57.1 FMC modules.

The FMC HPC Connector (J22) supports the below mentioned interface from Zynq Ultrascale+ MPSoC (ZU11/17/19EG).

- 10 GTH High Speed Transceivers
- 2 GTH Reference Clock
- Upto 06 LVDS IOs/12 Single ended (SE) IOs from HP Bank
- 2 Clock Input Capable LVDS/SE pins from HP Bank
- 1 Clock Output Capable LVDS/SE pins from HP Bank
- Upto 03 DIFF IOs/06 Single ended (SE) IOs from HD Bank
- 3 Clock Output Capable DIFF/SE pins from HD Bank
- Upto 1 Single ended (SE) IOs

This 400Pin FMC HPC connector (J22) is physically located at the top of the board as shown below.

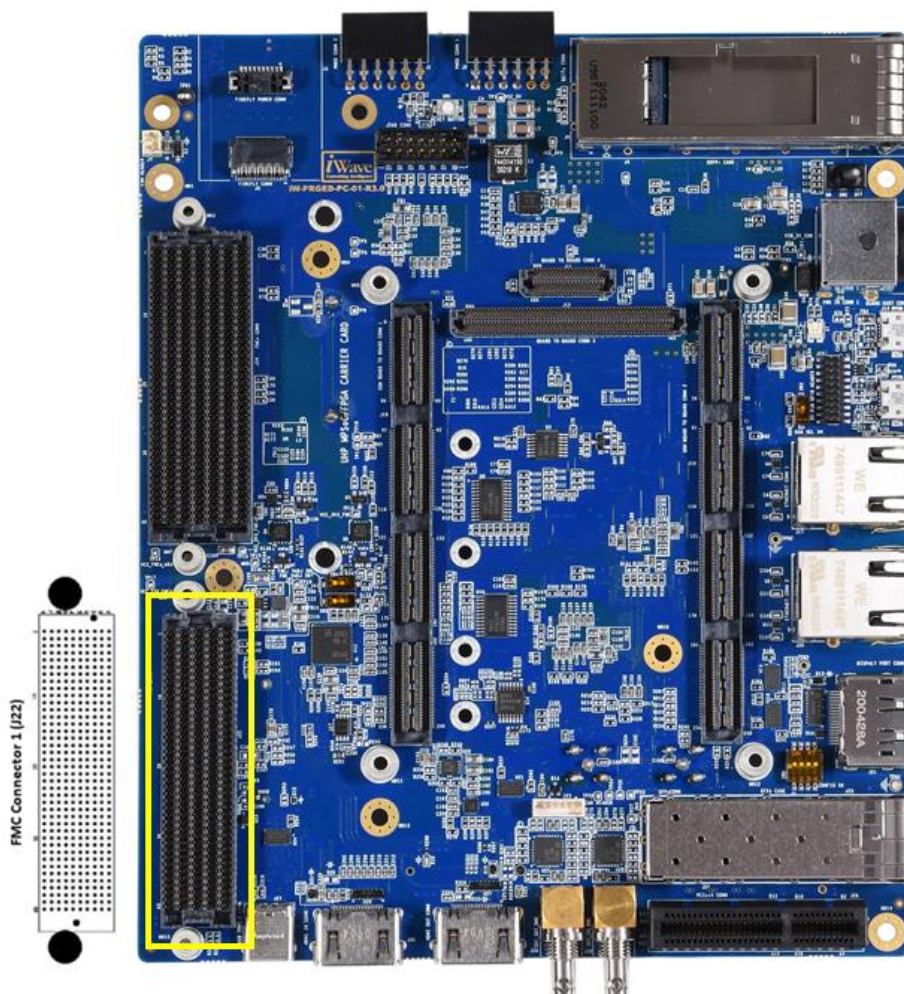

Figure 27: FMC Connector

This 400Pin FMC HPC connector (J22) pin mapping is shown below.

	K	J	H	G	F	E	D	C	B	A
1		GND	VREF_A_M2C	GND	PG_M2C	GND	PG_C2M	GND	CLK_DIR	GND
2		NC	PR5NT_M2C_L	CLK1_M2C_P		NC	GND	DP0_C2M_P	GND	DP1_M2C_P
3		NC	GND	CLK1_M2C_N		NC	GND	DP0_C2M_N	GND	DP1_M2C_N
4		GND	NC	GND	NC	GND	GBTCLK0_M2C_P	GND	DP9_M2C_P	GND
5		GND	NC	GND	NC	GND	GBTCLK0_M2C_N	GND	DP9_M2C_N	GND
6		NC	GND	LA00_P_CC		NC	GND	DP0_M2C_P	GND	DP2_M2C_P
7	NC	NC	LA02_P	LA00_N_CC	NC	NC	GND	DP0_M2C_N	GND	DP2_M2C_N
8	NC	GND	LA02_N	GND	NC	GND	LA01_P_CC	GND	DP8_M2C_P	GND
9		NC	GND	LA03_P		NC	LA01_N_CC	GND	DP8_M2C_N	GND
10	NC	NC	LA04_P	LA03_N	NC	NC	GND	LA06_P	GND	DP3_M2C_P
11	NC	GND	LA04_N	GND	NC	GND	LA05_P	LA06_N	GND	DP3_M2C_N
12		NC	GND	LA08_P		NC	LA05_N	GND	DP7_M2C_P	GND
13	NC	NC	LA07_P	LA08_N	NC	NC	GND	GND	DP7_M2C_N	GND
14	NC	GND	LA07_N	GND	NC	GND	LA09_P	LA10_P	GND	DP4_M2C_P
15		NC	GND	LA12_P		NC	LA09_N	LA10_N	GND	DP4_M2C_N
16	NC	NC	LA11_P	LA12_N	NC	NC	GND	GND	DP6_M2C_P	GND
17	NC	GND	LA11_N	GND	NC	GND	LA13_P	GND	DP6_M2C_N	GND
18		NC	GND	NC		NC	LA13_N	NC	GND	DP5_M2C_P
19	NC	NC	NC	NC	NC	NC	GND	NC	GND	DP5_M2C_N
20	NC	GND	NC	GND	NC	GND	NC	GND	GBTCLK1_M2C_P	GND
21		NC	GND	NC		NC	NC	GND	GBTCLK1_M2C_N	GND
22	NC	NC	NC	NC	NC	NC	GND	NC	GND	DP1_C2M_P
23	NC	GND	NC	GND	NC	GND	NC	NC	GND	DP1_C2M_N
24		NC	GND	NC		NC	NC	GND	DP9_C2M_P	GND
25	NC	NC	NC	NC	NC	NC	GND	GND	DP9_C2M_N	GND
26	NC	GND	NC	GND	NC	GND	NC	NC	GND	DP2_C2M_P
27		NC	GND	NC		NC	NC	NC	GND	DP2_C2M_N
28	NC	NC	NC	NC	NC	NC	GND	GND	DP8_C2M_P	GND
29	NC	GND	NC	GND	NC	GND	TCK	GND	DP8_C2M_N	GND
30		NC	GND	NC		NC	TDI	SCL	GND	DP3_C2M_P
31	NC	NC	NC	NC	NC	NC	TDO	SDA	GND	DP3_C2M_N
32	NC	GND	NC	GND	NC	GND	3P3VAUX	GND	DP7_C2M_P	GND
33		NC	GND	NC		NC	TMS	GND	DP7_C2M_N	GND
34	NC	NC	NC	NC	NC	NC	TRST_L	GA0	GND	DP4_C2M_P
35	NC	GND	NC	GND	NC	GND	GA1	12P0V	GND	DP4_C2M_N
36		NC	GND	NC		NC	3P3V	GND	DP6_C2M_P	GND
37	NC	NC	NC	NC	NC	NC	GND	12P0V	DP6_C2M_N	GND
38	NC	GND	NC	GND	NC	GND	3P3V	GND	GND	DP5_C2M_P
39		NC	GND	VADJ		VADJ	GND	3P3V	GND	DP5_C2M_N
40	NC	GND	VADJ	GND		GND	3P3V	GND	NC	GND

Figure 28: FMC HPC Connector Pin Out

Number of Pins - 400

Connector Part Number - ASP-134486-01

Mating Connector - ASP-134488-01 from Samtec

Staking Height - 10mm

Note:

* By default, FMC connector power is disabled as per Vita Specification. While booting the FMC Module EEPROM is read and enabling the FMC connector power.

* If FMC modules EEPROM is not programmed, then FMC connector power is not enabled.

Table 16: FMC HPC Connector Pin Assignment

Sl.no	FMC Connector VITA		Board to Board Connectors			Zynq Ultraascale+ MP SoC (FFVC1760)			Description
	FMC Connector Pin No	FMC Connector Pin Name	Board to Board Connector Number	Board to Board Connector Pin Number	Board to Board Connector Signal Name (SOM)	MPSoC Bank	MPSoC Pin No	Signal Type/ Termination*	
1	A1	GND	NA	NA	GND	NA	NA	Power	Ground.
2	A2	DP1_M2C_P	Board to Board Connector 1	17	GTHRXP1_224	224	AW2	I, DIFF	GTH Bank224 channel1 High speed differential receiver positive.
3	A3	DP1_M2C_N	Board to Board Connector 1	15	GTHRXN1_224	224	AW1	I, DIFF	GTH Bank224 channel1 High speed differential receiver Negative.
4	A4	GND	NA	NA	GND	NA	NA	Power	Ground.
5	A5	GND	NA	NA	GND	NA	NA	Power	Ground.
6	A6	DP2_M2C_P	Board to Board Connector 1	57	GTHRXP2_224	224	AV4	I, DIFF	GTH Bank224 channel2 High speed differential receiver positive.
7	A7	DP2_M2C_N	Board to Board Connector 1	55	GTHRXN2_224	224	AV3	I, DIFF	GTH Bank224 channel2 High speed differential receiver Negative.
8	A8	GND	NA	NA	GND	NA	NA	Power	Ground.
9	A9	GND	NA	NA	GND	NA	NA	Power	Ground.
10	A10	DP3_M2C_P	Board to Board Connector 1	51	GTHRXP3_224	224	AU2	I, DIFF	GTH Bank224 channel3 High speed differential receiver positive.
11	A11	DP3_M2C_N	Board to Board Connector 1	49	GTHRXN3_224	224	AU1	I, DIFF	GTH Bank224 channel3 High speed differential receiver Negative.
12	A12	GND	NA	NA	GND	NA	NA	Power	Ground.
13	A13	GND	NA	NA	GND	NA	NA	Power	Ground.
14	A14	DP4_M2C_P	Board to Board Connector 1	117	GTHRXP0_225	225	AT4	I, DIFF	GTH Bank225 channel0 High speed differential receiver positive.
15	A15	DP4_M2C_N	Board to Board Connector 1	115	GTHRXN0_225	225	AT3	I, DIFF	GTH Bank225 channel0 High speed differential receiver Negative.
16	A16	GND	NA	NA	GND	NA	NA	Power	Ground.
17	A17	GND	NA	NA	GND	NA	NA	Power	Ground.
18	A18	DP5_M2C_P	Board to Board Connector 1	111	GTHRXP1_225	225	AR2	I, DIFF	GTH Bank225 channel1 High speed differential receiver positive.
19	A19	DP5_M2C_N	Board to Board Connector 1	109	GTHRXN1_225	225	AR1	I, DIFF	GTH Bank225 channel1 High speed differential receiver Negative.
20	A20	GND	NA	NA	GND	NA	NA	Power	Ground.
21	A21	GND	NA	NA	GND	NA	NA	Power	Ground.
22	A22	DP1_C2M_P	Board to Board Connector 1	9	GTHTXP1_224	224	AW6	O, DIFF	GTH Bank224 channel1 High speed differential transmitter positive.
23	A23	DP1_C2M_N	Board to Board Connector 1	11	GTHTXN1_224	224	AW5	O, DIFF	GTH Bank224 channel1 High speed differential transmitter Negative.
24	A24	GND	NA	NA	GND	NA	NA	Power	Ground.
25	A25	GND	NA	NA	GND	NA	NA	Power	Ground.

Zynq-Ultrascale+ MPSoC (ZU11/17/19EG) SOM Development Platform Hardware User Guide

Sl.no	FMC Connector VITA		Board to Board Connectors			Zynq Ultraascale+ MP SoC (FFVC1760)			Description
	FMC Connector Pin No	FMC Connector Pin Name	Board to Board Connector Number	Board to Board Connector Pin Number	Board to Board Connector Signal Name (SOM)	MPSoC Bank	MPSoC Pin No	Signal Type/Termination*	
26	A26	DP2_C2M_P	Board to Board Connector 1	37	GTHTXP2_224	224	AU6	O, DIFF	GTH Bank224 channel2 High speed differential transmitter positive.
27	A27	DP2_C2M_N	Board to Board Connector 1	39	GTHTXN2_224	224	AU5	O, DIFF	GTH Bank224 channel2 High speed differential transmitter Negative.
28	A28	GND	NA	NA	GND	NA	NA	Power	Ground.
29	A29	GND	NA	NA	GND	NA	NA	Power	Ground.
30	A30	DP3_C2M_P	Board to Board Connector 1	43	GTHTXP3_224	224	AT8	O, DIFF	GTH Bank224 channel3 High speed differential transmitter positive.
31	A31	DP3_C2M_N	Board to Board Connector 1	45	GTHTXN3_224	224	AT7	O, DIFF	GTH Bank224 channel3 High speed differential transmitter Negative.
32	A32	GND	NA	NA	GND	NA	NA	Power	Ground.
33	A33	GND	NA	NA	GND	NA	NA	Power	Ground.
34	A34	DP4_C2M_P	Board to Board Connector 1	97	GTHTXP0_225	225	AR6	O, DIFF	GTH Bank225 channel0 High speed differential transmitter positive.
35	A35	DP4_C2M_N	Board to Board Connector 1	99	GTHTXN0_225	225	AR5	O, DIFF	GTH Bank225 channel0 High speed differential transmitter Negative.
36	A36	GND	NA	NA	GND	NA	NA	Power	Ground.
37	A37	GND	NA	NA	GND	NA	NA	Power	Ground.
38	A38	DP5_C2M_P	Board to Board Connector 1	103	GTHTXP1_225	225	AP8	O, DIFF	GTH Bank225 channel1 High speed differential transmitter positive.
39	A39	DP5_C2M_N	Board to Board Connector 1	105	GTHTXN1_225	225	AP7	O, DIFF	GTH Bank225 channel1 High speed differential transmitter Negative.
40	A40	GND	NA	NA	GND	NA	NA	Power	Ground.
41	B1	CLK_DIR	NA	NA	NA	NA	NA	O, 3.3V	CLK-DIR. This Pin is connected to 15th pin of IO Expander (U10).
42	B2	GND	NA	NA	GND	NA	NA	Power	Ground.
43	B3	GND	NA	NA	GND	NA	NA	Power	Ground.
44	B4	DP9_M2C_P	Board to Board Connector 2	187	GTHRXP0_227	227	AH4	I, DIFF	GTH Bank227 channel0 High speed differential receiver positive.
45	B5	DP9_M2C_N	Board to Board Connector 2	189	GTHRXP0_227	227	AH3	I, DIFF	GTH Bank227 channel0 High speed differential receiver Negative.
46	B6	GND	NA	NA	GND	NA	NA	Power	Ground.
47	B7	GND	NA	NA	GND	NA	NA	Power	Ground.
48	B8	DP8_M2C_P	Board to Board Connector 2	199	GTHRXP1_227	227	AG2	I, DIFF	GTH Bank227 channel1 High speed differential receiver positive.
49	B9	DP8_M2C_N	Board to Board Connector 2	201	GTHRXP1_227	227	AG1	I, DIFF	GTH Bank227 channel1 High speed differential receiver Negative.
50	B10	GND	NA	NA	GND	NA	NA	Power	Ground.
51	B11	GND	NA	NA	GND	NA	NA	Power	Ground.

Zynq-Ultrascale+ MPSoC (ZU11/17/19EG) SOM Development Platform Hardware User Guide

Sl.no	FMC Connector VITA		Board to Board Connectors			Zynq Ultraascale+ MP SoC (FFVC1760)			Description
	FMC Connector Pin No	FMC Connector Pin Name	Board to Board Connector Number	Board to Board Connector Pin Number	Board to Board Connector Signal Name (SOM)	MPSoC Bank	MPSoC Pin No	Signal Type/Termination*	
52	B12	DP7_M2C_P	Board to Board Connector 1	137	GTHRXP3_225	225	AN2	I, DIFF	GTH Bank225 channel3 High speed differential receiver positive.
53	B13	DP7_M2C_N	Board to Board Connector 1	135	GTHRXN3_225	225	AN1	I, DIFF	GTH Bank225 channel3 High speed differential receiver Negative.
54	B14	GND	NA	NA	GND	NA	NA	Power	Ground.
55	B15	GND	NA	NA	GND	NA	NA	Power	Ground.
56	B16	DP6_M2C_P	Board to Board Connector 1	143	GTHRXP2_225	225	AP4	I, DIFF	GTH Bank225 channel2 High speed differential receiver positive.
57	B17	DP6_M2C_N	Board to Board Connector 1	141	GTHRXN2_225	225	AP3	I, DIFF	GTH Bank225 channel2 High speed differential receiver Negative.
58	B18	GND	NA	NA	GND	NA	NA	Power	Ground.
59	B19	GND	NA	NA	GND	NA	NA	Power	Ground.
60	B20	GBTCLK1_M2C_P	Board to Board Connector 1	98	GTREFCLK0P_225	225	AH12	I, DIFF	GTH Bank225 differential reference clock0 positive.
61	B21	GBTCLK1_M2C_N	Board to Board Connector 1	100	GTREFCLK0N_225	225	AH11	I, DIFF	GTH Bank225 differential reference clock0 negative.
62	B22	GND	NA	NA	GND	NA	NA	Power	Ground.
63	B23	GND	NA	NA	GND	NA	NA	Power	Ground.
64	B24	DP9_C2M_P	Board to Board Connector 2	193	GTHTXP0_227	227	AG6	O, DIFF	GTH Bank227 channel0 High speed differential transmitter positive.
65	B25	DP9_C2M_N	Board to Board Connector 2	195	GTHTXN0_227	227	AG5	O, DIFF	GTH Bank227 channel0 High speed differential transmitter Negative.
66	B26	GND	NA	NA	GND	NA	NA	Power	Ground.
67	B27	GND	NA	NA	GND	NA	NA	Power	Ground.
68	B28	DP8_C2M_P	Board to Board Connector 2	205	GTHTXP1_227	227	AF8	O, DIFF	GTH Bank227 channel1 High speed differential transmitter positive.
69	B29	DP8_C2M_N	Board to Board Connector 2	207	GTHTXN1_227	227	AF7	O, DIFF	GTH Bank227 channel1 High speed differential transmitter Negative.
70	B30	GND	NA	NA	GND	NA	NA	Power	Ground.
71	B31	GND	NA	NA	GND	NA	NA	Power	Ground.
72	B32	DP7_C2M_P	Board to Board Connector 1	129	GTHTXP3_225	225	AM8	O, DIFF	GTH Bank225 channel3 High speed differential transmitter positive.
73	B33	DP7_C2M_N	Board to Board Connector 1	131	GTHTXN3_225	225	AM7	O, DIFF	GTH Bank225 channel3 High speed differential transmitter Negative.
74	B34	GND	NA	NA	GND	NA	NA	Power	Ground.
75	B35	GND	NA	NA	GND	NA	NA	Power	Ground.
76	B36	DP6_C2M_P	Board to Board Connector 1	123	GTHTXP2_225	225	AN6	O, DIFF	GTH Bank225 channel2 High speed differential transmitter positive.
77	B37	DP6_C2M_N	Board to Board Connector 1	125	GTHTXN2_225	225	AN5	O, DIFF	GTH Bank225 channel2 High speed differential transmitter Negative.

Zynq-Ultrascale+ MPSoC (ZU11/17/19EG) SOM Development Platform Hardware User Guide

Sl.no	FMC Connector VITA		Board to Board Connectors			Zynq Ultraascale+ MP SoC (FFVC1760)			Description
	FMC Connector Pin No	FMC Connector Pin Name	Board to Board Connector Number	Board to Board Connector Pin Number	Board to Board Connector Signal Name (SOM)	MPSoC Bank	MPSoC Pin No	Signal Type/Termination*	
78	B38	GND	NA	NA	GND	NA	NA	Power	Ground.
79	B39	GND	NA	NA	GND	NA	NA	Power	Ground.
80	B40	RES0	NA	NA	NA	NA	NA	NA	NC.
81	C1	GND	NA	NA	GND	NA	NA	Power	Ground.
82	C2	DPO_C2M_P	Board to Board Connector 1	3	GTHTXP0_224	224	AY4	O, DIFF	GTH Bank224 channel0 High speed differential transmitter positive.
83	C3	DPO_C2M_N	Board to Board Connector 1	5	GTHTXN0_224	224	AY3	O, DIFF	GTH Bank224 channel0 High speed differential transmitter Negative.
84	C4	GND	NA	NA	GND	NA	NA	Power	Ground.
85	C5	GND	NA	NA	GND	NA	NA	Power	Ground.
86	C6	DPO_M2C_P	Board to Board Connector 1	23	GTHRXPO_224	224	BA2	I, DIFF	GTH Bank224 channel0 High speed differential receiver positive.
87	C7	DPO_M2C_N	Board to Board Connector 1	21	GTHRXN0_224	224	BA1	I, DIFF	GTH Bank224 channel0 High speed differential receiver Negative.
88	C8	GND	NA	NA	GND	NA	NA	Power	Ground.
89	C9	GND	NA	NA	GND	NA	NA	Power	Ground.
90	C10	LA06_P	Board to Board Connector 2	122	PL_AM10_LVDS67_L18P	67	AM10	IO, 1.8V	PL Bank67 IO18 differential positive.
91	C11	LA06_N	Board to Board Connector 2	124	PL_AN10_LVDS67_L18N	67	AN10	IO, 1.8V	PL Bank67 IO18 differential negative
92	C12	GND	NA	NA	GND	NA	NA	Power	Ground.
93	C13	GND	NA	NA	GND	NA	NA	Power	Ground.
94	C14	LA10_P	Board to Board Connector 2	115	PL_F14_LVDS68_L13P_GC	68	F14	IO, 1.8V	PL Bank68 IO13 differential positive.
95	C15	LA10_N	Board to Board Connector 2	117	PL_E14_LVDS68_L13N_GC	68	E14	IO, 1.8V	PL Bank68 IO13 differential negative.
96	C16	GND	NA	NA	GND	NA	NA	Power	Ground.
97	C17	GND	NA	NA	GND	NA	NA	Power	Ground.
98	C18	LA14_P	NA	NA	NA	NA	NA	NA	NC.
99	C19	LA14_N	NA	NA	NA	NA	NA	NA	NC.
100	C20	GND	NA	NA	GND	NA	NA	Power	Ground.
101	C21	GND	NA	NA	GND	NA	NA	Power	Ground.
102	C22	LA18_P_CC	NA	NA	NA	NA	NA	NA	NC.
103	C23	LA18_N_CC	NA	NA	NA	NA	NA	NA	NC.
104	C24	GND	NA	NA	GND	NA	NA	Power	Ground.
105	C25	GND	NA	NA	GND	NA	NA	Power	Ground.
106	C26	LA27_P	NA	NA	NA	NA	NA	NA	NC.
107	C27	LA27_N	NA	NA	NA	NA	NA	NA	NC.
108	C28	GND	NA	NA	GND	NA	NA	Power	Ground.
109	C29	GND	NA	NA	GND	NA	NA	Power	Ground.

Zynq-Ultrascale+ MPSoC (ZU11/17/19EG) SOM Development Platform Hardware User Guide

Sl.no	FMC Connector VITA		Board to Board Connectors			Zynq Ultraascale+ MP SoC (FFVC1760)			Description
	FMC Connector Pin No	FMC Connector Pin Name	Board to Board Connector Number	Board to Board Connector Pin Number	Board to Board Connector Signal Name (SOM)	MPSoC Bank	MPSoC Pin No	Signal Type/Termination*	
110	C30	SCL	NA	NA	I2C0_SD3_SCL	NA	NA	O, 3.3V LVCMOS	FMC+ I2C Clock Signal. This Pin is connected from 12th pin of I2C Bus switch (U29).
111	C31	SDA	NA	NA	I2C0_SD3_SDA	NA	NA	IO, 3.3V LVCMOS	FMC+ I2C Data Signal. This Pin is connected from 11th pin of I2C Bus switch (U29).
112	C32	GND	NA	NA	GND	NA	NA	Power	Ground.
113	C33	GND	NA	NA	GND	NA	NA	Power	Ground.
114	C34	GA0	NA	NA	NA	NA	NA	1K, PU	Geographical address 0
115	C35	12POV	NA	NA	VCC_12V_FMC	NA	NA	O, 12V Power	Carrier Board Supply Voltage.
116	C36	GND	NA	NA	GND	NA	NA	Power	Ground.
117	C37	12POV	NA	NA	VCC_12V_FMC	NA	NA	O, 12V Power	Carrier Board Supply Voltage.
118	C38	GND	NA	NA	GND	NA	NA	Power	Ground.
119	C39	3P3V	NA	NA	VCC_3V3_FMC	NA	NA	O, 3.3V Power	Carrier Board Supply Voltage.
120	C40	GND	NA	NA	GND	NA	NA	Power	Ground.
121	D1	PG_C2M	NA	NA	NA	NA	NA	O, 3.3V	Power Good Signal from Carrier to FMC Module. This Pin is connected to 17th pin of IO Expander (U10).
122	D2	GND	NA	NA	GND	NA	NA	Power	Ground.
123	D3	GND	NA	NA	GND	NA	NA	Power	Ground.
124	D4	GBTCLK0_M2C_P	Board to Board Connector 1	4	GTREFCLK0P_224	224	AK12	I, DIFF	GTH Bank224 differential reference clock0 positive.
125	D5	GBTCLK0_M2C_N	Board to Board Connector 1	6	GTREFCLK0N_224	224	AK11	I, DIFF	GTH Bank224 differential reference clock0 Negative.
126	D6	GND	NA	NA	GND	NA	NA	Power	Ground.
127	D7	GND	NA	NA	GND	NA	NA	Power	Ground.
128	D8	LA01_P_CC	Board to Board Connector 1	87	PL_F5_LVDS94_L1P	94	F5	IO, 1.8V	PL Bank94 IO1 differential positive.
129	D9	LA01_N_CC	Board to Board Connector 1	89	PL_F4_LVDS94_L1N	94	F4	IO, 1.8V	PL Bank94 IO1 differential negative.
130	D10	GND	NA	NA	GND	NA	NA	Power	Ground.
131	D11	LA05_P	Board to Board Connector 2	123	PL_M17_LVDS68_L3P	68	M17	IO, 1.8V	PL Bank68 IO3 differential positive.
132	D12	LA05_N	Board to Board Connector 2	121	PL_M16_LVDS68_L3N	68	M16	IO, 1.8V	PL Bank68 IO3 differential negative
133	D13	GND	NA	NA	GND	NA	NA	Power	Ground.
134	D14	LA09_P	Board to Board Connector 2	116	PL_G17_LVDS68_L11P_GC	68	G17	IO, 1.8V	PL Bank68 IO11 differential positive.
135	D15	LA09_N	Board to Board Connector 2	118	PL_F17_LVDS68_L11N_GC	68	F17	IO, 1.8V	PL Bank68 IO11 differential negative.
136	D16	GND	NA	NA	GND	NA	NA	Power	Ground.
137	D17	LA13_P	Board to Board Connector 2	103	PL_E16_LVDS68_L19P_DBC	68	E16	IO, 1.8V	PL Bank68 IO19 differential positive.

Zynq-Ultrascale+ MPSoC (ZU11/17/19EG) SOM Development Platform Hardware User Guide

Sl.no	FMC Connector VITA		Board to Board Connectors			Zynq Ultraascale+ MP SoC (FFVC1760)			Description
	FMC Connector Pin No	FMC Connector Pin Name	Board to Board Connector Number	Board to Board Connector Pin Number	Board to Board Connector Signal Name (SOM)	MPSoC Bank	MPSoC Pin No	Signal Type/Termination*	
138	D18	LA13_N	Board to Board Connector 2	105	PL_D16_LVDS68_L19N_DBC	68	D16	IO, 1.8V	PL Bank68 IO19 differential negative.
139	D19	GND	NA	NA	GND	NA	NA	Power	Ground.
140	D20	LA17_P_CC	NA	NA	NA	NA	NA	NA	NC.
141	D21	LA17_N_CC	NA	NA	NA	NA	NA	NA	NC.
142	D22	GND	NA	NA	GND	NA	NA	Power	Ground.
143	D23	LA23_P	NA	NA	NA	NA	NA	NA	NC.
144	D24	LA23_N	NA	NA	NA	NA	NA	NA	NC.
145	D25	GND	NA	NA	GND	NA	NA	Power	Ground.
146	D26	LA26_P	NA	NA	NA	NA	NA	NA	NC.
147	D27	LA26_N	NA	NA	NA	NA	NA	NA	NC.
148	D28	GND	NA	NA	GND	NA	NA	Power	Ground.
149	D29	TCK	Board to Board Connector 2	31	PS_JTAG_TCK	503	AC26	I, 3.3V CMOS/ 49.9K PU	JTAG Test Clock This Pin is connected to 31st pin of Board to Board Connector2 (J19).
150	D30	TDI	NA	NA	NA	NA	NA	O, 3.3V CMOS	FMC+ Test Data Output. This pin is connected from D31st pin of FMC+ Connector(J14)
151	D31	TDO	NA	NA	FMC2_JTAG_TDO	NA	NA	O, 3.3V CMOS	NC
152	D32	3P3VAUX	NA	NA	VCC_3V3	NA	NA	O, 3.3V Power	Carrier Board Supply Voltage.
153	D33	TMS	Board to Board Connector 2	29	PS_JTAG_TMS	503	AD26	I, 3.3V CMOS/ 49.9K PU	JTAG Test Mode Select This Pin is connected to 29th pin of Board to Board Connector2 (J19).
154	D34	TRST_L	Board to Board Connector 2	25	NC	NC	NC	NA	NC. This Pin is connected to 25th pin of Board to Board Connector2 (J19).
155	D35	GA1	NA	NA	NA	NA	NA	1K, PD	Geographical address 1
156	D36	3P3V	NA	NA	VCC_3V3_FMC	NA	NA	O, 3.3V Power	Carrier Board Supply Voltage.
157	D37	GND	NA	NA	GND	NA	NA	Power	Ground.
158	D38	3P3V	NA	NA	VCC_3V3_FMC	NA	NA	O, 3.3V Power	Carrier Board Supply Voltage.
159	D39	GND	NA	NA	GND	NA	NA	Power	Ground.
160	D40	3P3V	NA	NA	VCC_3V3_FMC	NA	NA	O, 3.3V Power	Carrier Board Supply Voltage.
161	E1	GND	NA	NA	GND	NA	NA	Power	Ground.
162	E2	HA01_P_CC	NA	NA	NA	NA	NA	NA	NC.
163	E3	HA01_N_CC	NA	NA	NA	NA	NA	NA	NC.
164	E4	GND	NA	NA	GND	NA	NA	Power	Ground.
165	E5	GND	NA	NA	GND	NA	NA	Power	Ground.
166	E6	HA05_P	NA	NA	NA	NA	NA	NA	NC.
167	E7	HA05_N	NA	NA	NA	NA	NA	NA	NC.
168	E8	GND	NA	NA	GND	NA	NA	Power	Ground.

Zynq-Ultrascale+ MPSoC (ZU11/17/19EG) SOM Development Platform Hardware User Guide

Sl.no	FMC Connector VITA		Board to Board Connectors			Zynq Ultraascale+ MP SoC (FFVC1760)			Description
	FMC Connector Pin No	FMC Connector Pin Name	Board to Board Connector Number	Board to Board Connector Pin Number	Board to Board Connector Signal Name (SOM)	MPSoC Bank	MPSoC Pin No	Signal Type/Termination*	
169	E9	HA09_P	NA	NA	NA	NA	NA	NA	NC.
170	E10	HA09_N	NA	NA	NA	NA	NA	NA	NC.
171	E11	GND	NA	NA	GND	NA	NA	Power	Ground.
172	E12	HA13_P	NA	NA	NA	NA	NA	NA	NC.
173	E13	HA13_N	NA	NA	NA	NA	NA	NA	NC.
174	E14	GND	NA	NA	GND	NA	NA	Power	Ground.
175	E15	HA16_P	NA	NA	NA	NA	NA	NA	NC.
176	E16	HA16_N	NA	NA	NA	NA	NA	NA	NC.
177	E17	GND	NA	NA	GND	NA	NA	Power	Ground.
178	E18	HA20_P	NA	NA	NA	NA	NA	NA	NC.
179	E19	HA20_N	NA	NA	NA	NA	NA	NA	NC.
180	E20	GND	NA	NA	GND	NA	NA	Power	Ground.
181	E21	HB03_P	NA	NA	NA	NA	NA	NA	NC.
182	E22	HB03_N	NA	NA	NA	NA	NA	NA	NC.
183	E23	GND	NA	NA	GND	NA	NA	Power	Ground.
184	E24	HB05_P	NA	NA	NA	NA	NA	NA	NC.
185	E25	HB05_N	NA	NA	NA	NA	NA	NA	NC.
186	E26	GND	NA	NA	GND	NA	NA	Power	Ground.
187	E27	HB09_P	NA	NA	NA	NA	NA	NA	NC.
188	E28	HB09_N	NA	NA	NA	NA	NA	NA	NC.
189	E29	GND	NA	NA	GND	NA	NA	Power	Ground.
190	E30	HB13_P	NA	NA	NA	NA	NA	NA	NC.
191	E31	HB13_N	NA	NA	NA	NA	NA	NA	NC.
192	E32	GND	NA	NA	GND	NA	NA	Power	Ground.
193	E33	HB19_P	NA	NA	NA	NA	NA	NA	NC.
194	E34	HB19_N	NA	NA	NA	NA	NA	NA	NC.
195	E35	GND	NA	NA	GND	NA	NA	Power	Ground.
196	E36	HB21_P	NA	NA	NA	NA	NA	NA	NC.
197	E37	HB21_N	NA	NA	NA	NA	NA	NA	NC.
198	E38	GND	NA	NA	GND	NA	NA	Power	Ground.
199	E39	VADJ	NA	NA	VCC_FMC_ADJ	NA	NA	O, 1.8V Power	Carrier Board Supply Voltage.
200	E40	GND	NA	NA	GND	NA	NA	Power	Ground.
201	F1	PG_M2C	NA	NA	NA	NA	NA	I, 3.3V CMOS/ 10K PU	Power Good Signal from FMC Module to Carrier.
202	F2	GND	NA	NA	GND	NA	NA	Power	Ground.
203	F3	GND	NA	NA	GND	NA	NA	Power	Ground.
204	F4	HA00_P_CC	NA	NA	NA	NA	NA	NA	NC.
205	F5	HA00_N_CC	NA	NA	NA	NA	NA	NA	NC.
206	F6	GND	NA	NA	GND	NA	NA	Power	Ground.

Zynq-Ultrascale+ MPSoC (ZU11/17/19EG) SOM Development Platform Hardware User Guide

Sl.no	FMC Connector VITA		Board to Board Connectors			Zynq Ultraascale+ MP SoC (FFVC1760)			Description
	FMC Connector Pin No	FMC Connector Pin Name	Board to Board Connector Number	Board to Board Connector Pin Number	Board to Board Connector Signal Name (SOM)	MPSoC Bank	MPSoC Pin No	Signal Type/Termination*	
207	F7	HA04_P	NA	NA	NA	NA	NA	NA	NC.
208	F8	HA04_N	NA	NA	NA	NA	NA	NA	NC.
209	F9	GND	NA	NA	GND	NA	NA	Power	Ground.
210	F10	HA08_P	NA	NA	NA	NA	NA	NA	NC.
211	F11	HA08_N	NA	NA	NA	NA	NA	NA	NC.
212	F12	GND	NA	NA	GND	NA	NA	Power	Ground.
213	F13	HA12_P	NA	NA	NA	NA	NA	NA	NC.
214	F14	HA12_N	NA	NA	NA	NA	NA	NA	NC.
215	F15	GND	NA	NA	GND	NA	NA	Power	Ground.
216	F16	HA15_P	NA	NA	NA	NA	NA	NA	NC.
217	F17	HA15_N	NA	NA	NA	NA	NA	NA	NC.
218	F18	GND	NA	NA	GND	NA	NA	Power	Ground.
219	F19	HA19_P	NA	NA	NA	NA	NA	NA	NC.
220	F20	HA19_N	NA	NA	NA	NA	NA	NA	NC.
221	F21	GND	NA	NA	GND	NA	NA	Power	Ground.
222	F22	HB02_P	NA	NA	NA	NA	NA	NA	NC.
223	F23	HB02_N	NA	NA	NA	NA	NA	NA	NC.
224	F24	GND	NA	NA	GND	NA	NA	Power	Ground.
225	F25	HB04_P	NA	NA	NA	NA	NA	NA	NC.
226	F26	HB04_N	NA	NA	NA	NA	NA	NA	NC.
227	F27	GND	NA	NA	GND	NA	NA	Power	Ground.
228	F28	HB08_P	NA	NA	NA	NA	NA	NA	NC.
229	F29	HB08_N	NA	NA	NA	NA	NA	NA	NC.
230	F30	GND	NA	NA	GND	NA	NA	Power	Ground.
231	F31	HB12_P	NA	NA	NA	NA	NA	NA	NC.
232	F32	HB12_N	NA	NA	NA	NA	NA	NA	NC.
233	F33	GND	NA	NA	GND	NA	NA	Power	Ground.
234	F34	HB16_P	NA	NA	NA	NA	NA	NA	NC.
235	F35	HB16_N	NA	NA	NA	NA	NA	NA	NC.
236	F36	GND	NA	NA	GND	NA	NA	Power	Ground.
237	F37	HB20_P	NA	NA	NA	NA	NA	NA	NC.
238	F38	HB20_N	NA	NA	NA	NA	NA	NA	NC.
239	F39	GND	NA	NA	GND	NA	NA	Power	Ground.
240	F40	VADJ	NA	NA	VCC_FMC_ADJ	NA	NA	O, 1.8V Power	Carrier Board Supply Voltage.
241	G1	GND	NA	NA	GND	NA	NA	Power	Ground.
242	G2	CLK1_M2C_P	Board to Board connector 1	144	PL_C4_LVDS94_L8P_HDGC	94	C4	IO, DIFF	PL Bank94 IO8 differential positive.
243	G3	CLK1_M2C_N	Board to Board connector 1	142	PL_C3_LVDS94_L8N_HDGC	94	C3	IO, DIFF	PL Bank94 IO8 differential negative.
244	G4	GND	NA	NA	GND	NA	NA	Power	Ground.
245	G5	GND	NA	NA	GND	NA	NA	Power	Ground.

Zynq-Ultrascale+ MPSoC (ZU11/17/19EG) SOM Development Platform Hardware User Guide

Sl.no	FMC Connector VITA		Board to Board Connectors			Zynq Ultraascale+ MP SoC (FFVC1760)			Description
	FMC Connector Pin No	FMC Connector Pin Name	Board to Board Connector Number	Board to Board Connector Pin Number	Board to Board Connector Signal Name (SOM)	MPSoC Bank	MPSoC Pin No	Signal Type/Termination*	
246	G6	LA00_P_CC	Board to Board connector 1	118	PL_D4_LVDS94_L5P_HDGC	94	D4	IO, 1.8V	PL Bank94 IO5 differential positive.
247	G7	LA00_N_CC	Board to Board connector 1	116	PL_D3_LVDS94_L5N_HDGC	94	D3	IO, 1.8V	PL Bank94 IO5 differential negative.
248	G8	GND	NA	NA	GND	NA	NA	Power	Ground.
249	G9	LA03_P	Board to Board connector 2	126	PL_AL15_LVDS67_L19P_DBC	67	AL15	IO, 1.8V	PL Bank67 IO19 differential positive.
250	G10	LA03_N	Board to Board connector 2	128	PL_AM15_LVDS67_L19N_DBC	67	AM15	IO, 1.8V	PL Bank67 IO19 differential negative.
251	G11	GND	NA	NA	GND	NA	NA	Power	Ground.
252	G12	LA08_P	Board to Board connector 2	127	PL_H15_LVDS68_L7P_QBC	68	H15	IO, 1.8V	PL Bank68 IO7 differential positive.
253	G13	LA08_N	Board to Board connector 2	125	PL_G15_LVDS68_L7N_QBC	68	G15	IO, 1.8V	PL Bank68 IO7 differential negative.
254	G14	GND	NA	NA	GND	NA	NA	Power	Ground.
255	G15	LA12_P	Board to Board connector 2	109	PL_G16_LVDS68_L12P_GC	68	G16	IO, 1.8V	PL Bank68 IO12 differential positive.
256	G16	LA12_N	Board to Board connector 2	111	PL_F15_LVDS68_L12N_GC	68	F15	IO, 1.8V	PL Bank68 IO12 differential negative.
257	G17	GND	NA	NA	GND	NA	NA	Power	Ground.
258	G18	LA16_P	NA	NA	NA	NA	NA	NA	IO expander U51
259	G19	LA16_N	Board to Board connector 2	112	PL_D14_LVDS68_L14N_GC	68	D14	IO, 1.8V	PL Bank68 IO14 differential negative.
260	G20	GND	NA	NA	GND	NA	NA	Power	Ground.
261	G21	LA20_P	NA	NA	NA	NA	NA	NA	NC.
262	G22	LA20_N	NA	NA	NA	NA	NA	NA	NC.
263	G23	GND	NA	NA	GND	NA	NA	Power	Ground.
264	G24	LA22_P	NA	NA	NA	NA	NA	NA	NC.
265	G25	LA22_N	NA	NA	NA	NA	NA	NA	NC.
266	G26	GND	NA	NA	GND	NA	NA	Power	Ground.
267	G27	LA25_P	NA	NA	NA	NA	NA	NA	NC.
268	G28	LA25_N	NA	NA	NA	NA	NA	NA	NC.
269	G29	GND	NA	NA	GND	NA	NA	Power	Ground.
270	G30	LA29_P	NA	NA	NA	NA	NA	NA	NC.
271	G31	LA29_N	NA	NA	NA	NA	NA	NA	NC.
272	G32	GND	NA	NA	GND	NA	NA	Power	Ground.
273	G33	LA31_P	NA	NA	NA	NA	NA	NA	NC.
274	G34	LA31_N	NA	NA	NA	NA	NA	NA	NC.
275	G35	GND	NA	NA	GND	NA	NA	Power	Ground.
276	G36	LA33_P	NA	NA	NA	NA	NA	NA	NC.
277	G37	LA33_N	NA	NA	NA	NA	NA	NA	NC.
278	G38	GND	NA	NA	GND	NA	NA	Power	Ground.
279	G39	VADJ	NA	NA	VCC_FMC_ADJ	NA	NA	O, 1.8V Power	Carrier Board Supply Voltage.
280	G40	GND	NA	NA	GND	NA	NA	Power	Ground.
281	H1	VREF_A_M2C	NA	NA	NA	NA	NA	NA	NC.

Zynq-Ultrascale+ MPSoC (ZU11/17/19EG) SOM Development Platform Hardware User Guide

Sl.no	FMC Connector VITA		Board to Board Connectors			Zynq Ultraascale+ MP SoC (FFVC1760)			Description
	FMC Connector Pin No	FMC Connector Pin Name	Board to Board Connector Number	Board to Board Connector Pin Number	Board to Board Connector Signal Name (SOM)	MPSoC Bank	MPSoC Pin No	Signal Type/Termination*	
282	H2	PRSNT_M2C_L	NA	NA	NA	NA	NA	I,3.3V CMOS/ 10K PU	Module Preset Signal. This Pin is connected to 4th pin of IO Expander (U10).
283	H3	GND	NA	NA	GND	NA	NA	Power	Ground.
284	H4	CLK0_M2C_P	NA	NA	NA	NA	NA	NA	NC.
285	H5	CLK0_M2C_N	NA	NA	NA	NA	NA	NA	NC.
286	H6	GND	NA	NA	GND	NA	NA	Power	Ground.
287	H7	LA02_P	Board to Board connector 1	46	PL_A5_LVDS94_L12P	94	A5	IO, 1.8V	PL Bank94 IO12 differential positive.
288	H8	LA02_N	Board to Board connector 1	48	PL_A4_LVDS94_L12N	94	A4	IO, 1.8V	PL Bank94 IO12 differential negative.
289	H9	GND	NA	NA	GND	NA	NA	Power	Ground.
290	H10	LA04_P	Board to Board connector 1	24	PL_D8_LVDS93_L8P_HDGC	93	D8	IO, 1.8V	PL Bank93 IO8 differential positive.
291	H11	LA04_N	Board to Board connector 1	22	PL_C8_LVDS93_L8N_HDGC	93	C8	IO, 1.8V	PL Bank93 IO8 differential negative.
292	H12	GND	NA	NA	GND	NA	NA	Power	Ground.
293	H13	LA07_P	Board to Board connector 1	50	PL_B2_LVDS94_L9P	94	B2	IO, 1.8V	PL Bank94 IO9 differential positive.
294	H14	LA07_N	Board to Board connector 1	52	PL_B1_LVDS94_L9N	94	B1	IO, 1.8V	PL Bank94 IO9 differential negative.
295	H15	GND	NA	NA	GND	NA	NA	Power	Ground.
296	H16	LA11_P	Board to Board connector 2	95	PL_K16_LVDS68_L5P	68	K16	IO, 1.8V	PL Bank68 IO5 differential positive.
297	H17	LA11_N	Board to Board connector 2	97	PL_K15_LVDS68_L5N	68	K15	IO, 1.8V	PL Bank68 IO5 differential negative.
298	H18	GND	NA	NA	GND	NA	NA	Power	Ground.
299	H19	LA15_P	NA	NA	NA	NA	NA	NA	NC.
300	H20	LA15_N	NA	NA	NA	NA	NA	NA	NC.
301	H21	GND	NA	NA	GND	NA	NA	Power	Ground.
302	H22	LA19_P	NA	NA	NA	NA	NA	NA	NC.
303	H23	LA19_N	NA	NA	NA	NA	NA	NA	NC.
304	H24	GND	NA	NA	GND	NA	NA	Power	Ground.
305	H25	LA21_P	NA	NA	NA	NA	NA	NA	NC.
306	H26	LA21_N	NA	NA	NA	NA	NA	NA	NC.
307	H27	GND	NA	NA	GND	NA	NA	Power	Ground.
308	H28	LA24_P	NA	NA	NA	NA	NA	NA	NC.
309	H29	LA24_N	NA	NA	NA	NA	NA	NA	NC.
310	H30	GND	NA	NA	GND	NA	NA	Power	Ground.
311	H31	LA28_P	NA	NA	NA	NA	NA	NA	NC.
312	H32	LA28_N	NA	NA	NA	NA	NA	NA	NC.
313	H33	GND	NA	NA	GND	NA	NA	Power	Ground.
314	H34	LA30_P	NA	NA	NA	NA	NA	NA	NC.
315	H35	LA30_N	NA	NA	NA	NA	NA	NA	NC.
316	H36	GND	NA	NA	GND	NA	NA	Power	Ground.
317	H37	LA32_P	NA	NA	NA	NA	NA	NA	NC.
318	H38	LA32_N	NA	NA	NA	NA	NA	NA	NC.

Zynq-Ultrascale+ MPSoC (ZU11/17/19EG) SOM Development Platform Hardware User Guide

Sl.no	FMC Connector VITA		Board to Board Connectors			Zynq Ultraascale+ MP SoC (FFVC1760)			Description
	FMC Connector Pin No	FMC Connector Pin Name	Board to Board Connector Number	Board to Board Connector Pin Number	Board to Board Connector Signal Name (SOM)	MPSoC Bank	MPSoC Pin No	Signal Type/Termination*	
319	H39	GND	NA	NA	GND	NA	NA	Power	Ground.
320	H40	VADJ	NA	NA	VCC_FMC_ADJ	NA	NA	O, 1.8V Power	Carrier Board Supply Voltage.
321	J1	GND	NA	NA	GND	NA	NA	Power	Ground.
322	J2	CLK3_BIDIR_P	NA	NA	NA	NA	NA	NA	NC.
323	J3	CLK3_BIDIR_N	NA	NA	NA	NA	NA	NA	NC.
324	J4	GND	NA	NA	GND	NA	NA	Power	Ground.
325	J5	GND	NA	NA	GND	NA	NA	Power	Ground.
326	J6	HA03_P	NA	NA	NA	NA	NA	NA	NC.
327	J7	HA03_N	NA	NA	NA	NA	NA	NA	NC.
328	J8	GND	NA	NA	GND	NA	NA	Power	Ground.
329	J9	HA07_P	NA	NA	NA	NA	NA	NA	NC.
330	J10	HA07_N	NA	NA	NA	NA	NA	NA	NC.
331	J11	GND	NA	NA	GND	NA	NA	Power	Ground.
332	J12	HA11_P	NA	NA	NA	NA	NA	NA	NC.
333	J13	HA11_N	NA	NA	NA	NA	NA	NA	NC.
334	J14	GND	NA	NA	GND	NA	NA	Power	Ground.
335	J15	HA14_P	NA	NA	NA	NA	NA	NA	NC.
336	J16	HA14_N	NA	NA	NA	NA	NA	NA	NC.
337	J17	GND	NA	NA	GND	NA	NA	Power	Ground.
338	J18	HA18_P	NA	NA	NA	NA	NA	NA	NC.
339	J19	HA18_N	NA	NA	NA	NA	NA	NA	NC.
340	J20	GND	NA	NA	GND	NA	NA	Power	Ground.
341	J21	HA22_P	NA	NA	NA	NA	NA	NA	NC.
342	J22	HA22_N	NA	NA	NA	NA	NA	NA	NC.
343	J23	GND	NA	NA	GND	NA	NA	Power	Ground.
344	J24	HB01_P	NA	NA	NA	NA	NA	NA	NC.
345	J25	HB01_N	NA	NA	NA	NA	NA	NA	NC.
346	J26	GND	NA	NA	GND	NA	NA	Power	Ground.
347	J27	HB07_P	NA	NA	NA	NA	NA	NA	NC.
348	J28	HB07_N	NA	NA	NA	NA	NA	NA	NC.
349	J29	GND	NA	NA	GND	NA	NA	Power	Ground.
350	J30	HB11_P	NA	NA	NA	NA	NA	NA	NC.
351	J31	HB11_N	NA	NA	NA	NA	NA	NA	NC.
352	J32	GND	NA	NA	GND	NA	NA	Power	Ground.
353	J33	HB15_P	NA	NA	NA	NA	NA	NA	NC.
354	J34	HB15_N	NA	NA	NA	NA	NA	NA	NC.
355	J35	GND	NA	NA	GND	NA	NA	Power	Ground.
356	J36	HB18_P	NA	NA	NA	NA	NA	NA	NC.
357	J37	HB18_N	NA	NA	NA	NA	NA	NA	NC.

Zynq-Ultrascale+ MPSoC (ZU11/17/19EG) SOM Development Platform Hardware User Guide

Sl.no	FMC Connector VITA		Board to Board Connectors			Zynq Ultraascale+ MP SoC (FFVC1760)			Description
	FMC Connector Pin No	FMC Connector Pin Name	Board to Board Connector Number	Board to Board Connector Pin Number	Board to Board Connector Signal Name (SOM)	MPSoC Bank	MPSoC Pin No	Signal Type/Termination*	
358	J38	GND	NA	NA	GND	NA	NA	Power	Ground.
359	J39	VIO_B_M2C	NA	NA	NA	NA	NA	NA	NC.
360	J40	GND	NA	NA	GND	NA	NA	Power	Ground.
361	K1	VREF_B_M2C	NA	NA	NA	NA	NA	NA	NC.
362	K2	GND	NA	NA	GND	NA	NA	Power	Ground.
363	K3	GND	NA	NA	GND	NA	NA	Power	Ground.
364	K4	CLK2_BIDIR_P	NA	NA	NA	NA	NA	NA	NC.
365	K5	CLK2_BIDIR_N	NA	NA	NA	NA	NA	NA	NC.
366	K6	GND	NA	NA	GND	NA	NA	Power	Ground.
367	K7	HA02_P	NA	NA	NA	NA	NA	NA	NC.
368	K8	HA02_N	NA	NA	NA	NA	NA	NA	NC.
369	K9	GND	NA	NA	GND	NA	NA	Power	Ground.
370	K10	HA06_P	NA	NA	NA	NA	NA	NA	NC.
371	K11	HA06_N	NA	NA	NA	NA	NA	NA	NC.
372	K12	GND	NA	NA	GND	NA	NA	Power	Ground.
373	K13	HA10_P	NA	NA	NA	NA	NA	NA	NC.
374	K14	HA10_N	NA	NA	NA	NA	NA	NA	NC.
375	K15	GND	NA	NA	GND	NA	NA	Power	Ground.
376	K16	HA17_P_CC	NA	NA	NA	NA	NA	NA	NC.
377	K17	HA17_N_CC	NA	NA	NA	NA	NA	NA	NC.
378	K18	GND	NA	NA	GND	NA	NA	Power	Ground.
379	K19	HA21_P	NA	NA	NA	NA	NA	NA	NC.
380	K20	HA21_N	NA	NA	NA	NA	NA	NA	NC.
381	K21	GND	NA	NA	GND	NA	NA	Power	Ground.
382	K22	HA23_P	NA	NA	NA	NA	NA	NA	NC.
383	K23	HA23_N	NA	NA	NA	NA	NA	NA	NC.
384	K24	GND	NA	NA	GND	NA	NA	Power	Ground.
385	K25	HB00_P_CC	NA	NA	NA	NA	NA	NA	NC.
386	K26	HB00_N_CC	NA	NA	NA	NA	NA	NA	NC.
387	K27	GND	NA	NA	GND	NA	NA	Power	Ground.
388	K28	HB06_P_CC	NA	NA	NA	NA	NA	NA	NC.
389	K29	HB06_N_CC	NA	NA	NA	NA	NA	NA	NC.
390	K30	GND	NA	NA	GND	NA	NA	Power	Ground.
391	K31	HB10_P	NA	NA	NA	NA	NA	NA	NC.
392	K32	HB10_N	NA	NA	NA	NA	NA	NA	NC.
393	K33	GND	NA	NA	GND	NA	NA	Power	Ground.
394	K34	HB14_P	NA	NA	NA	NA	NA	NA	NC.
395	K35	HB14_N	NA	NA	NA	NA	NA	NA	NC.
396	K36	GND	NA	NA	GND	NA	NA	Power	Ground.

Sl.no	FMC Connector VITA		Board to Board Connectors			Zynq Ultraascale+ MP SoC (FFVC1760)			Description
	FMC Connector Pin No	FMC Connector Pin Name	Board to Board Connector Number	Board to Board Connector Pin Number	Board to Board Connector Signal Name (SOM)	MPSoC Bank	MPSoC Pin No	Signal Type/Termination*	
397	K37	HB17_P_CC	NA	NA	NA	NA	NA	NA	NC.
398	K38	HB17_N_CC	NA	NA	NA	NA	NA	NA	NC.
399	K39	GND	NA	NA	GND	NA	NA	Power	Ground.
400	K40	VIO_B_M2C	NA	NA	NA	NA	NA	NA	NC.

Note:

*FMC connector supports VADJ 1.8V and 1.2V. By default, VADJ is set to 1.8V. Contact iWave for further details.

* If VCC_FMC_ADJ voltage changed from default value 1.8 to 1.2V, Please make sure that SOM concern IO voltage also to be modified to avoid IO conflict.

*IO Type of IOs originating from ZU19/17/11 MPSoC is configurable. Hence for exact IO type configuration options, refer Xilinx ZU19/17/11 MPSoC datasheet.

2.5.6 FMC+ HPC Connector

The Zynq Ultrascale+ MPSoC (ZU11/17/19EG) Carrier board supports one 560Pin FMC+ HPC connector to support standard ANSI/VITA 57.4 FMC modules.

The FMC+ HPC Connector (J14) supports the below mentioned interface from Zynq Ultrascale+ MPSoC (ZU11/17/19EG) SOM module.

- 8 GTY High Speed Transceivers
- 2 GTY Reference Clock
- 16 GTH High Speed Transceivers
- 4 GTH Reference Clock
- Upto 20 LVDS IOs/40 Single ended (SE) IOs from HP Bank
- 2 Clock Input Capable LVDS/SE pins from HP Bank
- 2 Clock Output Capable LVDS/SE pins from HP Bank
- Upto 09 DIFF IOs/18 Single ended (SE) IOs from HD Bank
- 3 Clock Input Capable LVDS/SE pins from HD Bank

This 560Pin FMC+ HPC connector (J14) is physically located at the top of the board as shown below.

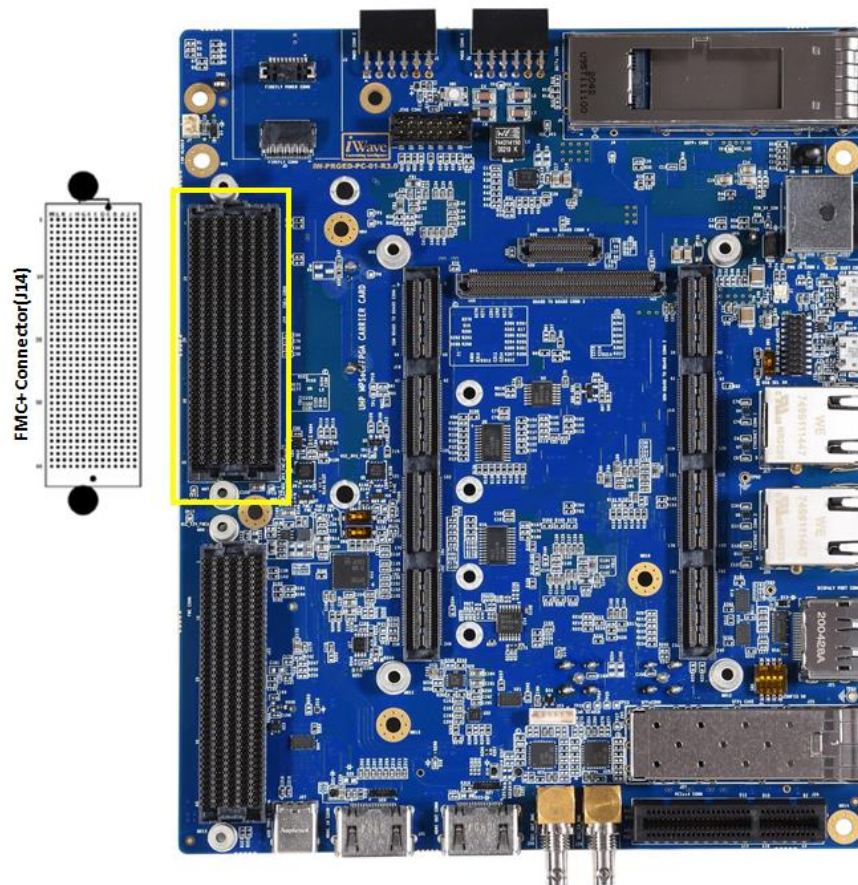

Figure 29: FMC+ Connector

This 560Pin FMC HPC connector (J14) pin mapping is shown below.

	M	L	K	J	H	G	F	E	D	C	B	A	Z	Y
1	GND	NC	NC	GND	NC	GND	PG_M2C	GND	PG_C2M	GND	CLK_DIR	GND	HSPC_PRSNL_M2C_L	GND
2	DP23_M2C_P	GND	GND	CLK3_BIDIR_P	PRSNL_M2C_L	CLK1_M2C_P	GND	NC	GND	DP0_C2M_P	GND	DP1_M2C_P	GND	DP23_C2M_P
3	DP23_M2C_N	GND	GND	CLK3_BIDIR_N	GND	CLK1_M2C_N	GND	NC	GND	DP0_C2M_N	GND	DP1_M2C_N	GND	DP23_C2M_N
4	GND	GBTCLK4_M2C_P	NC	GND	NC	GND	NC	GND	GBTCLK0_M2C_P	GND	DP9_M2C_P	GND	DP22_C2M_P	GND
5	GND	GBTCLK4_M2C_N	NC	GND	NC	GND	NC	GND	GBTCLK0_M2C_N	GND	DP9_M2C_N	GND	DP22_C2M_N	GND
6	DP22_M2C_P	GND	GND	NC	GND	LA00_P_CC	GND	NC	GND	DP0_M2C_P	GND	DP2_M2C_P	GND	DP21_C2M_P
7	DP22_M2C_N	GND	NC	NC	LA02_P	LA00_N_CC	NC	NC	GND	DP0_M2C_N	GND	DP2_M2C_N	GND	DP21_C2M_N
8	GND	GBTCLK3_M2C_P	NC	GND	LA02_N	GND	NC	GND	LA01_P_CC	GND	DP8_M2C_P	GND	DP20_C2M_P	GND
9	GND	GBTCLK3_M2C_N	GND	NC	GND	LA03_P	GND	NC	LA01_N_CC	GND	DP8_M2C_N	GND	DP20_C2M_N	GND
10	DP21_M2C_P	GND	NC	NC	LA04_P	LA03_N	NC	NC	GND	LA06_P	GND	DP3_M2C_P	GND	DP10_M2C_P
11	DP21_M2C_N	GND	NC	GND	LA04_N	GND	NC	GND	LA05_P	LA06_N	GND	DP3_M2C_N	GND	DP10_M2C_N
12	GND	GBTCLK2_M2C_P	GND	NC	GND	LA08_P	GND	NC	LA05_N	GND	DP7_M2C_P	GND	DP11_M2C_P	GND
13	GND	GBTCLK2_M2C_N	NC	NC	LA07_P	LA08_N	NC	NC	GND	GND	DP7_M2C_N	GND	DP11_M2C_N	GND
14	DP20_M2C_P	GND	NC	GND	LA07_N	GND	NC	GND	LA09_P	LA10_P	GND	DP4_M2C_P	GND	DP12_M2C_P
15	DP20_M2C_N	GND	GND	NC	GND	LA12_P	GND	NC	LA09_N	LA10_N	GND	DP4_M2C_N	GND	DP12_M2C_N
16	GND	NC	NC	NC	LA11_P	LA12_N	NC	NC	GND	GND	DP6_M2C_P	GND	DP13_M2C_P	GND
17	GND	NC	NC	GND	LA11_N	GND	NC	GND	LA13_P	GND	DP6_M2C_N	GND	DP13_M2C_N	GND
18	DP14_C2M_P	GND	GND	NC	GND	LA16_P	GND	NC	LA13_N	LA14_P	GND	DP5_M2C_P	GND	DP14_M2C_P
19	DP14_C2M_N	GND	NC	NC	LA15_P	LA16_N	NC	NC	GND	LA14_N	GND	DP5_M2C_N	GND	DP14_M2C_N
20	GND	NC	NC	GND	LA15_N	GND	NC	GND	LA17_P_CC	GND	GBTCLK1_M2C_P	GND	GBTCLK5_M2C_P	GND
21	GND	NC	GND	NC	GND	LA20_P	GND	NC	LA17_N_CC	GND	GBTCLK1_M2C_N	GND	GBTCLK5_M2C_N	GND
22	DP15_C2M_P	GND	NC	NC	LA19_P	LA20_N	NC	NC	GND	LA18_P_CC	GND	DP1_C2M_P	GND	DP15_M2C_P
23	DP15_C2M_N	GND	NC	GND	LA19_N	GND	NC	GND	LA23_P	LA18_N_CC	GND	DP1_C2M_N	GND	DP15_M2C_N
24	GND	NC	GND	NC	GND	LA22_P	GND	NC	LA23_N	GND	DP9_C2M_P	GND	DP10_C2M_P	GND
25	GND	NC	NC	NC	LA21_P	LA22_N	NC	NC	GND	GND	DP9_C2M_N	GND	DP10_C2M_N	GND
26	DP16_C2M_P	GND	NC	GND	LA21_N	GND	NC	GND	LA26_P	LA27_P	GND	DP2_C2M_P	GND	DP11_C2M_P
27	DP16_C2M_N	GND	GND	NC	GND	LA25_P	GND	NC	LA26_N	LA27_N	GND	DP2_C2M_N	GND	DP11_C2M_N
28	GND	NC	NC	NC	LA24_P	LA25_N	NC	NC	GND	GND	DP8_C2M_P	GND	DP12_C2M_P	GND
29	GND	NC	NC	GND	LA24_N	GND	NC	GND	TCK	GND	DP8_C2M_N	GND	DP12_C2M_N	GND
30	DP17_C2M_P	GND	GND	NC	GND	LA29_P	GND	NC	TDI	SCL	GND	DP3_C2M_P	GND	DP13_C2M_P
31	DP17_C2M_N	GND	NC	NC	LA28_P	LA29_N	NC	NC	TDO	SDA	GND	DP3_C2M_N	GND	DP13_C2M_N
32	GND	NC	GND	NC	LA28_N	GND	NC	GND	3P3VAUX	GND	DP7_C2M_P	GND	DP16_M2C_P	GND
33	GND	NC	GND	NC	GND	LA31_P	GND	NC	TMS	GND	DP7_C2M_N	GND	DP16_M2C_N	GND
34	DP18_C2M_P	GND	NC	NC	LA30_P	LA31_N	NC	NC	TRST_L	GA0	GND	DP4_C2M_P	GND	DP17_M2C_P
35	DP18_C2M_N	GND	NC	GND	LA30_N	GND	NC	GND	GA1	12P0V	GND	DP4_C2M_N	GND	DP17_M2C_N
36	GND	12P0V	GND	NC	GND	LA33_P	GND	NC	3P3V	GND	DP6_C2M_P	GND	DP18_M2C_P	GND
37	GND	12P0V	NC	NC	LA32_P	LA33_N	NC	NC	GND	12P0V	DP6_C2M_N	GND	DP18_M2C_N	GND
38	DP19_C2M_P	GND	NC	GND	LA32_N	GND	NC	GND	3P3V	GND	GND	DP5_C2M_P	GND	DP19_M2C_P
39	DP19_C2M_N	GND	GND	NC	GND	VADJ	GND	VADJ	GND	3P3V	GND	DP5_C2M_N	GND	DP19_M2C_N
40	GND	12P0V	VIO_B_M2C	GND	VADJ	GND	VADJ	GND	3P3V	GND	RES0	GND	3P3V	GND

Figure 30: FMC+ HPC Connector Pin Out

Number of Pins - 560

Connector Part Number - ASP-184329-01 from Samtec

Mating Connector - ASP-184330-01 from Samtec

Staking Height - 10mm

Note:

* By default, FMC+ connector power is disabled as per Vita Specification. While booting the FMC or FMC+ Modules EEPROM is read and enabling the FMC+ connector power.

* If FMC & FMC+ modules EEPROM is not programmed, then FMC+ connector power is not enabled.

Table 17: FMC+ HPC Connector Pin Assignment

Sl.no	FMC+ Connector VITA		Board to Board Connectors			Zynq Ultraascale+ MP SoC (FFVC1760)			Description
	FMC+ Connector Pin No	FMC+ Connector Pin Name	Board to Board Connector Number	Board to Board Connector Pin Number	Board to Board Connector Signal Name (SOM)	MPSoC Bank	MPSoC Pin No	Signal Type/Termination*	
1	A1	GND	NA	NA	GND	NA	NA	Power	Ground.
2	A2	DP1_M2C_P	Board to Board Connector 3	A36	GTYRXP1_129	129	P39	I, DIFF	GTY Bank129 channel1 High speed differential receiver positive.
3	A3	DP1_M2C_N	Board to Board Connector 3	A37	GTYRXN1_129	129	P40	I, DIFF	GTY Bank129 channel1 High speed differential receiver negative.
4	A4	GND	NA	NA	GND	NA	NA	Power	Ground.
5	A5	GND	NA	NA	GND	NA	NA	Power	Ground.
6	A6	DP2_M2C_P	Board to Board Connector 3	A25	GTYRXP2_129	129	N41	I, DIFF	GTY Bank129 channel2 High speed differential receiver positive.
7	A7	DP2_M2C_N	Board to Board Connector 3	A24	GTYRXN2_129	129	N42	I, DIFF	GTY Bank129 channel2 High speed differential receiver negative.
8	A8	GND	NA	NA	GND	NA	NA	Power	Ground.
9	A9	GND	NA	NA	GND	NA	NA	Power	Ground.
10	A10	DP3_M2C_P	Board to Board Connector 3	B23	GTYRXP3_129	129	M39	I, DIFF	GTY Bank129 channel3 High speed differential receiver positive.
11	A11	DP3_M2C_N	Board to Board Connector 3	B22	GTYRXN3_129	129	M40	I, DIFF	GTY Bank129 channel3 High speed differential receiver negative.
12	A12	GND	NA	NA	GND	NA	NA	Power	Ground.
13	A13	GND	NA	NA	GND	NA	NA	Power	Ground.
14	A14	DP4_M2C_P	Board to Board Connector 3	C9	GTYRXP0_130	130	L41	I, DIFF	GTY Bank130 channel0 High speed differential receiver positive.
15	A15	DP4_M2C_N	Board to Board Connector 3	C8	GTYRXN0_130	130	L42	I, DIFF	GTY Bank130 channel0 High speed differential receiver negative.
16	A16	GND	NA	NA	GND	NA	NA	Power	Ground.
17	A17	GND	NA	NA	GND	NA	NA	Power	Ground.
18	A18	DP5_M2C_P	Board to Board Connector 3	C29	GTYRXP1_130	130	K39	I, DIFF	GTY Bank130 channel1 High speed differential receiver positive.
19	A19	DP5_M2C_N	Board to Board Connector 3	C28	GTYRXN1_130	130	K40	I, DIFF	GTY Bank130 channel1 High speed differential receiver negative.
20	A20	GND	NA	NA	GND	NA	NA	Power	Ground.
21	A21	GND	NA	NA	GND	NA	NA	Power	Ground.
22	A22	DP1_C2M_P	Board to Board Connector 3	B30	GTYTXP1_129	129	R36	O, DIFF	GTY Bank129 channel1 High speed differential transmitter positive.
23	A23	DP1_C2M_N	Board to Board Connector 3	B31	GTYTXN1_129	129	R37	O, DIFF	GTY Bank129 channel1 High speed differential transmitter negative.
24	A24	GND	NA	NA	GND	NA	NA	Power	Ground.
25	A25	GND	NA	NA	GND	NA	NA	Power	Ground.

Zynq-Ultrascale+ MPSoC (ZU11/17/19EG) SOM Development Platform Hardware User Guide

Sl.no	FMC+ Connector VITA		Board to Board Connectors			Zynq Ultraascale+ MP SoC (FFVC1760)			Description
	FMC+ Connector Pin No	FMC+ Connector Pin Name	Board to Board Connector Number	Board to Board Connector Pin Number	Board to Board Connector Signal Name (SOM)	MPSoC Bank	MPSoC Pin No	Signal Type/Termination*	
26	A26	DP2_C2M_P	Board to Board Connector 3	A28	GTYXP2_129	129	P34	O, DIFF	GTY Bank129 channel2 High speed differential transmitter positive.
27	A27	DP2_C2M_N	Board to Board Connector 3	A29	GTYXN2_129	129	P35	O, DIFF	GTY Bank129 channel2 High speed differential transmitter negative.
28	A28	GND	NA	NA	GND	NA	NA	Power	Ground.
29	A29	GND	NA	NA	GND	NA	NA	Power	Ground.
30	A30	DP3_C2M_P	Board to Board Connector 3	B26	GTYXP3_129	129	N36	O, DIFF	GTY Bank129 channel3 High speed differential transmitter positive.
31	A31	DP3_C2M_N	Board to Board Connector 3	B27	GTYXN3_129	129	N37	O, DIFF	GTY Bank129 channel3 High speed differential transmitter negative.
32	A32	GND	NA	NA	GND	NA	NA	Power	Ground.
33	A33	GND	NA	NA	GND	NA	NA	Power	Ground.
34	A34	DP4_C2M_P	Board to Board Connector 3	C41	GTYXP0_130	130	M34	O, DIFF	GTY Bank130 channel0 High speed differential transmitter positive.
35	A35	DP4_C2M_N	Board to Board Connector 3	C40	GTYXN0_130	130	M35	O, DIFF	GTY Bank130 channel0 High speed differential transmitter negative.
36	A36	GND	NA	NA	GND	NA	NA	Power	Ground.
37	A37	GND	NA	NA	GND	NA	NA	Power	Ground.
38	A38	DP5_C2M_P	Board to Board Connector 3	C13	GTYXP1_130	130	L36	O, DIFF	GTY Bank130 channel1 High speed differential transmitter positive.
39	A39	DP5_C2M_N	Board to Board Connector 3	C12	GTYXN1_130	130	L37	O, DIFF	GTY Bank130 channel1 High speed differential transmitter negative.
40	A40	GND	NA	NA	GND	NA	NA	Power	Ground.
41	B1	CLK_DIR	NA	NA	NA	NA	NA	O, 3.3V	CLK-DIR This Pin is connected to 16th pin of IO Expander (U10).
42	B2	GND	NA	NA	GND	NA	NA	Power	Ground.
43	B3	GND	NA	NA	GND	NA	NA	Power	Ground.
44	B4	DP9_M2C_P	Board to Board Connector 3	D43	GTHXP1_231	231	L2	I, DIFF	GTH Bank231 channel1 High speed differential receiver positive.
45	B5	DP9_M2C_N	Board to Board Connector 3	D42	GTHXN1_231	231	L1	I, DIFF	GTH Bank231 channel1 High speed differential receiver Negative.
46	B6	GND	NA	NA	GND	NA	NA	Power	Ground.
47	B7	GND	NA	NA	GND	NA	NA	Power	Ground.
48	B8	DP8_M2C_P	Board to Board Connector 3	D51	GTHXP0_231	231	M4	I, DIFF	GTH Bank231 channel0 High speed differential receiver positive.
49	B9	DP8_M2C_N	Board to Board Connector 3	D50	GTHXN0_231	231	M3	I, DIFF	GTH Bank231 channel0 High speed differential receiver negative.
50	B10	GND	NA	NA	GND	NA	NA	Power	Ground.
51	B11	GND	NA	NA	GND	NA	NA	Power	Ground.

Zynq-Ultrascale+ MPSoC (ZU11/17/19EG) SOM Development Platform Hardware User Guide

Sl.no	FMC+ Connector VITA		Board to Board Connectors			Zynq Ultraascale+ MP SoC (FFVC1760)			Description
	FMC+ Connector Pin No	FMC+ Connector Pin Name	Board to Board Connector Number	Board to Board Connector Pin Number	Board to Board Connector Signal Name (SOM)	MPSoC Bank	MPSoC Pin No	Signal Type/Termination*	
52	B12	DP7_M2C_P	Board to Board Connector 3	C25	GTYRXP3_130	130	H39	I, DIFF	GTY Bank130 channel3 High speed differential receiver positive.
53	B13	DP7_M2C_N	Board to Board Connector 3	C24	GTYRXN3_130	130	H40	I, DIFF	GTY Bank130 channel3 High speed differential receiver negative.
54	B14	GND	NA	NA	GND	NA	NA	Power	Ground.
55	B15	GND	NA	NA	GND	NA	NA	Power	Ground.
56	B16	DP6_M2C_P	Board to Board Connector 3	C4	GTYRXP2_130	130	J41	I, DIFF	GTY Bank130 channel2 High speed differential receiver positive.
57	B17	DP6_M2C_N	Board to Board Connector 3	C5	GTYRXN2_130	130	J42	I, DIFF	GTY Bank130 channel2 High speed differential receiver negative.
58	B18	GND	NA	NA	GND	NA	NA	Power	Ground.
59	B19	GND	NA	NA	GND	NA	NA	Power	Ground.
60	B20	GBTCLK1_M2C_P	Board to Board Connector 3	C20	GTREFCLK0P_130	130	R32	I, DIFF	GTY Bank130 differential reference clock0 positive.
61	B21	GBTCLK1_M2C_N	Board to Board Connector 3	C21	GTREFCLK0N_130	130	R33	I, DIFF	GTY Bank130 differential reference clock0 negative.
62	B22	GND	NA	NA	GND	NA	NA	Power	Ground.
63	B23	GND	NA	NA	GND	NA	NA	Power	Ground.
64	B24	DP9_C2M_P	Board to Board Connector 3	C57	GTHTXP1_231	231	K4	O, DIFF	GTH Bank231 channel1 High speed differential Transmitter positive.
65	B25	DP9_C2M_N	Board to Board Connector 3	C56	GTHTXN1_231	231	K3	O, DIFF	GTH Bank231 channel1 High speed differential Transmitter Negative.
66	B26	GND	NA	NA	GND	NA	NA	Power	Ground.
67	B27	GND	NA	NA	GND	NA	NA	Power	Ground.
68	B28	DP8_C2M_P	Board to Board Connector 3	C52	GTHTXP0_231	231	L6	O, DIFF	GTH Bank231 channel0 High speed differential transmitter positive.
69	B29	DP8_C2M_N	Board to Board Connector 3	C53	GTHTXN0_231	231	L5	O, DIFF	GTH Bank231 channel0 High speed differential transmitter negative.
70	B30	GND	NA	NA	GND	NA	NA	Power	Ground.
71	B31	GND	NA	NA	GND	NA	NA	Power	Ground.
72	B32	DP7_C2M_P	Board to Board Connector 3	C33	GTYTYP3_130	130	J36	O, DIFF	GTY Bank130 channel3 High speed differential transmitter positive.
73	B33	DP7_C2M_N	Board to Board Connector 3	C32	GTYTXN3_130	130	J37	O, DIFF	GTY Bank130 channel3 High speed differential transmitter negative.
74	B34	GND	NA	NA	GND	NA	NA	Power	Ground.
75	B35	GND	NA	NA	GND	NA	NA	Power	Ground.
76	B36	DP6_C2M_P	Board to Board Connector 3	C37	GTYTYP2_130	130	K34	O, DIFF	GTY Bank130 channel2 High speed differential transmitter positive.
77	B37	DP6_C2M_N	Board to Board Connector 3	C36	GTYTXN2_130	130	K35	O, DIFF	GTY Bank130 channel2 High speed differential transmitter negative.

Zynq-Ultrascale+ MPSoC (ZU11/17/19EG) SOM Development Platform Hardware User Guide

Sl.no	FMC+ Connector VITA		Board to Board Connectors			Zynq Ultraascale+ MP SoC (FFVC1760)			Description
	FMC+ Connector Pin No	FMC+ Connector Pin Name	Board to Board Connector Number	Board to Board Connector Pin Number	Board to Board Connector Signal Name (SOM)	MPSoC Bank	MPSoC Pin No	Signal Type/Termination*	
78	B38	GND	NA	NA	GND	NA	NA	Power	Ground.
79	B39	GND	NA	NA	GND	NA	NA	Power	Ground.
80	B40	RES0	NA	NA	NA	NA	NA	NA	NC.
81	C1	GND	NA	NA	GND	NA	NA	Power	Ground.
82	C2	DPO_C2M_P	Board to Board Connector 3	A32	GTYTXP0_129	129	T34	O, DIFF	GTY Bank129 channel0 High speed differential transmitter positive.
83	C3	DPO_C2M_N	Board to Board Connector 3	A33	GTYTXN0_129	129	T35	O, DIFF	GTY Bank129 channel0 High speed differential transmitter negative.
84	C4	GND	NA	NA	GND	NA	NA	Power	Ground.
85	C5	GND	NA	NA	GND	NA	NA	Power	Ground.
86	C6	DPO_M2C_P	Board to Board Connector 3	A40	GTYRXPO_129	129	R41	I, DIFF	GTY Bank129 channel0 High speed differential receiver positive.
87	C7	DPO_M2C_N	Board to Board Connector 3	A41	GTYRXN0_129	129	R42	I, DIFF	GTY Bank129 channel0 High speed differential receiver negative.
88	C8	GND	NA	NA	GND	NA	NA	Power	Ground.
89	C9	GND	NA	NA	GND	NA	NA	Power	Ground.
90	C10	LA06_P	Board to Board Connector 2	183	PL_AV12_LVDS67_L7P_QBC	67	AV12	IO, 1.8V	PL Bank67 IO7 differential positive.
91	C11	LA06_N	Board to Board Connector 2	181	PL_AW12_LVDS67_L7N_QBC	67	AW12	IO, 1.8V	PL Bank67 IO7 differential negative.
92	C12	GND	NA	NA	GND	NA	NA	Power	Ground.
93	C13	GND	NA	NA	GND	NA	NA	Power	Ground.
94	C14	LA10_P	Board to Board Connector 2	176	PL_AT13_LVDS67_L11P_GC	67	AT13	IO, 1.8V	PL Bank67 IO11 differential positive.
95	C15	LA10_N	Board to Board Connector 2	178	PL_AT12_LVDS67_L11N_GC	67	AT12	IO, 1.8V	PL Bank67 IO11 differential negative.
96	C16	GND	NA	NA	GND	NA	NA	Power	Ground.
97	C17	GND	NA	NA	GND	NA	NA	Power	Ground.
98	C18	LA14_P	Board to Board Connector 2	147	PL_AR15_LVDS67_L15P	67	AR15	IO, 1.8V	PL Bank67 IO15 differential positive.
99	C19	LA14_N	Board to Board Connector 2	149	PL_AR14_LVDS67_L15N	67	AR14	IO, 1.8V	PL Bank67 IO15 differential negative.
100	C20	GND	NA	NA	GND	NA	NA	Power	Ground.
101	C21	GND	NA	NA	GND	NA	NA	Power	Ground.
102	C22	LA18_P_CC	Board to Board Connector 2	152	PL_AM13_LVDS67_L23P	67	AM13	IO, 1.8V	PL Bank67 IO23 differential positive.
103	C23	LA18_N_CC	Board to Board Connector 2	154	PL_AN13_LVDS67_L23N	67	AN13	IO, 1.8V	PL Bank67 IO23 differential negative.
104	C24	GND	NA	NA	GND	NA	NA	Power	Ground.
105	C25	GND	NA	NA	GND	NA	NA	Power	Ground.
106	C26	LA27_P	Board to Board Connector 1	27	PL_J8_LVDS93_L2P	93	J8	IO, 1.8V	PL Bank93 IO2 differential positive.
107	C27	LA27_N	Board to Board Connector 1	29	PL_H8_LVDS93_L2N	93	H8	IO, 1.8V	PL Bank93 IO2 differential negative .
108	C28	GND	NA	NA	GND	NA	NA	Power	Ground.
109	C29	GND	NA	NA	GND	NA	NA	Power	Ground.

Zynq-Ultrascale+ MPSoC (ZU11/17/19EG) SOM Development Platform Hardware User Guide

Sl.no	FMC+ Connector VITA		Board to Board Connectors			Zynq Ultraascale+ MP SoC (FFVC1760)			Description
	FMC+ Connector Pin No	FMC+ Connector Pin Name	Board to Board Connector Number	Board to Board Connector Pin Number	Board to Board Connector Signal Name (SOM)	MPSoC Bank	MPSoC Pin No	Signal Type/Termination*	
110	C30	SCL	NA	NA	I2C0_SD3_SCL	NA	NA	O, LVCMOS 3.3V	FMC+ I2C Clock Signal. This Pin is connected from 12th pin of I2C Bus switch (U29).
111	C31	SDA	NA	NA	I2C0_SD3_SDA	NA	NA	IO, LVCMOS 3.3V	FMC+ I2C Data Signal. This Pin is connected from 11th pin of I2C Bus switch (U29).
112	C32	GND	NA	NA	GND	NA	NA	Power	Ground.
113	C33	GND	NA	NA	GND	NA	NA	Power	Ground.
114	C34	GA0	NA	NA	NA	NA	NA	1K, PU	Geographical address 0
115	C35	12P0V	NA	NA	VCC_12V_FMC+	NA	NA	O, 12V Power	Carrier Board Supply Voltage.
116	C36	GND	NA	NA	GND	NA	NA	Power	Ground.
117	C37	12P0V	NA	NA	VCC_12V_FMC+	NA	NA	O, 12V Power	Carrier Board Supply Voltage.
118	C38	GND	NA	NA	GND	NA	NA	Power	Ground.
119	C39	3P3V	NA	NA	VCC_3V3_FMC+	NA	NA	O, 3.3V Power	Carrier Board Supply Voltage.
120	C40	GND	NA	NA	GND	NA	NA	Power	Ground.
121	D1	PG_C2M	NA	NA	NA	NA	NA	O, 3.3V	Power Good Signal from Carrier to FMC Module. This Pin is connected to 18th pin of IO Expander (U10).
122	D2	GND	NA	NA	GND	NA	NA	Power	Ground.
123	D3	GND	NA	NA	GND	NA	NA	Power	Ground.
124	D4	GBTCLK0_M2C_P	Board to Board Connector 3	B38	GTREFCLK0P_129	129	W32	I, DIFF	GT Bank129 differential reference clock0 positive.
125	D5	GBTCLK0_M2C_N	Board to Board Connector 3	B39	GTREFCLK0N_129	129	W33	I, DIFF	GT Bank129 differential reference clock0 negative.
126	D6	GND	NA	NA	GND	NA	NA	Power	Ground.
127	D7	GND	NA	NA	GND	NA	NA	Power	Ground.
128	D8	LA01_P_CC	Board to Board Connector 2	132	PL_BB9_LVDS67_L2P	67	BB9	IO, 1.8V	PL Bank67 IO2 differential positive.
129	D9	LA01_N_CC	Board to Board Connector 2	134	PL_BB8_LVDS67_L2N	67	BB8	IO, 1.8V	PL Bank67 IO2 differential negative.
130	D10	GND	NA	NA	GND	NA	NA	Power	Ground.
131	D11	LA05_P	Board to Board Connector 2	148	PL_BB5_LVDS67_L6P	67	BB5	IO, 1.8V	PL Bank67 IO6 differential positive.
132	D12	LA05_N	Board to Board Connector 2	150	PL_BB4_LVDS67_L6N	67	BB4	IO, 1.8V	PL Bank67 IO6 differential negative .
133	D13	GND	NA	NA	GND	NA	NA	Power	Ground.
134	D14	LA09_P	Board to Board Connector 2	164	PL_AV9_LVDS67_L10P_QBC	67	AV9	IO, 1.8V	PL Bank67 IO10 differential positive.
135	D15	LA09_N	Board to Board Connector 2	166	PL_AV8_LVDS67_L10N_QBC	67	AV8	IO, 1.8V	PL Bank67 IO10 differential negative.
136	D16	GND	NA	NA	GND	NA	NA	Power	Ground.
137	D17	LA13_P	Board to Board Connector 2	169	PL_AP10_LVDS67_L14P_GC	67	AP10	IO, 1.8V	PL Bank67 IO14 differential positive.

Zynq-Ultrascale+ MPSoC (ZU11/17/19EG) SOM Development Platform Hardware User Guide

Sl.no	FMC+ Connector VITA		Board to Board Connectors			Zynq Ultraascale+ MP SoC (FFVC1760)			Description
	FMC+ Connector Pin No	FMC+ Connector Pin Name	Board to Board Connector Number	Board to Board Connector Pin Number	Board to Board Connector Signal Name (SOM)	MPSoC Bank	MPSoC Pin No	Signal Type/Termination*	
138	D18	LA13_N	Board to Board Connector 2	171	PL_AR10_LVDS67_L14N_GC	67	AR10	IO, 1.8V	PL Bank67 IO14 differential negative.
139	D19	GND	NA	NA	GND	NA	NA	Power	Ground.
140	D20	LA17_P_CC	Board to Board Connector 2	144	PL_AL14_LVDS67_L21P	67	AL14	IO, 1.8V	PL Bank67 IO21 differential positive.
141	D21	LA17_N_CC	Board to Board Connector 2	146	PL_AM14_LVDS67_L21N	67	AM14	IO, 1.8V	PL Bank67 IO21 differential negative .
142	D22	GND	NA	NA	GND	NA	NA	Power	Ground.
143	D23	LA23_P	Board to Board Connector 1	32	PL_D9_LVDS93_L12P	93	D9	IO, DIFF	PL Bank93 IO12 differential positive.
144	D24	LA23_N	Board to Board Connector 1	34	PL_C9_LVDS93_L12N	93	C9	IO, DIFF	PL Bank93 IO12 differential negative .
145	D25	GND	NA	NA	GND	NA	NA	Power	Ground.
146	D26	LA26_P	Board to Board Connector 1	38	PL_E6_LVDS93_L9P	93	E6	IO, DIFF	PL Bank93 IO9 differential positive.
147	D27	LA26_N	Board to Board Connector 1	40	PL_D6_LVDS93_L9N	93	D6	IO, DIFF	PL Bank93 IO9 differential negative.
148	D28	GND	NA	NA	GND	NA	NA	Power	Ground.
149	D29	TCK	Board to Board Connector 2	31	PS_JTAG_TCK	503	AC26	I, 3.3V CMOS/ 49.9K PU	JTAG Test Clock. This Pin is connected to 31st pin of Board to Board Connector2 (J19) through Voltage level translator.
150	D30	TDI	Board to Board Connector 2	33	JTAG_TDO	NA	NA	O, 3.3V CMOS	JTAG Test Data Output. This Pin is connected to 33rd pin of Board to Board Connector2 (J19) through Voltage level translator.
151	D31	TDO	NA	NA	NA	NA	NA	O, 3.3V CMOS	FMC+ Test Data Output. This pin is connected to D30th pin of FMC Connector(J22)
152	D32	3P3VAUX	NA	NA	VCC_3V3	NA	NA	O, 3.3V Power	Carrier Board Supply Voltage.
153	D33	TMS	Board to Board Connector 2	29	PS_JTAG_TMS	503	AD26	I, 3.3V CMOS/ 49.9K PU	JTAG Test Mode Select. This Pin is connected to 29th pin of Board to Board Connector2 (J19) through Voltage level translator..
154	D34	TRST_L	Board to Board Connector 2	25	NC	NA	NA	NA	NC. This Pin is connected to 25th pin of Board to Board Connector2 (J8) through Voltage level translator.
155	D35	GA1	NA	NA	NA	NA	NA	1K, PU	Geographical address 1
156	D36	3P3V	NA	NA	VCC_3V3_FMC+	NA	NA	O, 3.3V Power	Carrier Board Supply Voltage.
157	D37	GND	NA	NA	GND	NA	NA	Power	Ground.
158	D38	3P3V	NA	NA	VCC_3V3_FMC+	NA	NA	O, 3.3V Power	Carrier Board Supply Voltage.
159	D39	GND	NA	NA	GND	NA	NA	Power	Ground.
160	D40	3P3V	NA	NA	VCC_3V3_FMC+	NA	NA	O, 3.3V Power	Carrier Board Supply Voltage.
161	E1	GND	NA	NA	GND	NA	NA	Power	Ground.

Zynq-Ultrascale+ MPSoC (ZU11/17/19EG) SOM Development Platform Hardware User Guide

Sl.no	FMC+ Connector VITA		Board to Board Connectors			Zynq UltraScale+ MP SoC (FFVC1760)			Description
	FMC+ Connector Pin No	FMC+ Connector Pin Name	Board to Board Connector Number	Board to Board Connector Pin Number	Board to Board Connector Signal Name (SOM)	MPSoC Bank	MPSoC Pin No	Signal Type/Termination*	
162	E2	HA01_P_CC	NA	NA	NC	NA	NA	NA	NC.
163	E3	HA01_N_CC	NA	NA	NC	NA	NA	NA	NC.
164	E4	GND	NA	NA	GND	NA	NA	Power	Ground.
165	E5	GND	NA	NA	GND	NA	NA	Power	Ground.
166	E6	HA05_P	Board to Board connector 1	128	NC	NA	NA	NA	NA
167	E7	HA05_N	Board to Board connector 1	134	NC	NA	NA	NA	NA
168	E8	GND	NA	NA	GND	NA	NA	Power	Ground.
169	E9	HA09_P	Board to Board connector 1	112	NC	NA	NA	NA	NA
170	E10	HA09_N	Board to Board connector 1	110	NC	NA	NA	NA	NA
171	E11	GND	NA	NA	GND	NA	NA	Power	Ground.
172	E12	HA13_P	NA	NA	NC	NA	NA	NA	NC.
173	E13	HA13_N	NA	NA	NC	NA	NA	NA	NC.
174	E14	GND	NA	NA	GND	NA	NA	Power	Ground.
175	E15	HA16_P	NA	NA	NC	NA	NA	NA	NC.
176	E16	HA16_N	NA	NA	NC	NA	NA	NA	NC.
177	E17	GND	NA	NA	GND	NA	NA	Power	Ground.
178	E18	HA20_P	NA	NA	NC	NA	NA	NA	NC.
179	E19	HA20_N	NA	NA	NC	NA	NA	NA	NC.
180	E20	GND	NA	NA	GND	NA	NA	Power	Ground.
181	E21	HB03_P	NA	NA	NC	NA	NA	NA	NC.
182	E22	HB03_N	NA	NA	NC	NA	NA	NA	NC.
183	E23	GND	NA	NA	GND	NA	NA	Power	Ground.
184	E24	HB05_P	NA	NA	NC	NA	NA	NA	NC.
185	E25	HB05_N	NA	NA	NC	NA	NA	NA	NC.
186	E26	GND	NA	NA	GND	NA	NA	Power	Ground.
187	E27	HB09_P	NA	NA	NC	NA	NA	NA	NC.
188	E28	HB09_N	NA	NA	NC	NA	NA	NA	NC.
189	E29	GND	NA	NA	GND	NA	NA	Power	Ground.
190	E30	HB13_P	NA	NA	NC	NA	NA	NA	NC.
191	E31	HB13_N	NA	NA	NC	NA	NA	NA	NC.
192	E32	GND	NA	NA	GND	NA	NA	Power	Ground.
193	E33	HB19_P	NA	NA	NC	NA	NA	NA	NC.
194	E34	HB19_N	NA	NA	NC	NA	NA	NA	NC.
195	E35	GND	NA	NA	GND	NA	NA	Power	Ground.
196	E36	HB21_P	NA	NA	NC	NA	NA	NA	NC.
197	E37	HB21_N	NA	NA	NC	NA	NA	NA	NC.
198	E38	GND	NA	NA	GND	NA	NA	Power	Ground.
199	E39	VADJ	NA	NA	VCC_FMC+_ADJ	NA	NA	O, 1.8V Power	Carrier Board Supply Voltage.
200	E40	GND	NA	NA	GND	NA	NA	Power	Ground.

Zynq-Ultrascale+ MPSoC (ZU11/17/19EG) SOM Development Platform Hardware User Guide

Sl.no	FMC+ Connector VITA		Board to Board Connectors			Zynq Ultraascale+ MP SoC (FFVC1760)			Description
	FMC+ Connector Pin No	FMC+ Connector Pin Name	Board to Board Connector Number	Board to Board Connector Pin Number	Board to Board Connector Signal Name (SOM)	MPSoC Bank	MPSoC Pin No	Signal Type/Termination*	
201	F1	PG_M2C	NA	NA	NA	NA	NA	I, 3.3V CMOS/10K PU	DNP. Power Good Signal from FMC Module to Carrier. This Pin is connected to 20th pin of IO Expander (U10).
202	F2	GND	NA	NA	GND	NA	NA	Power	Ground.
203	F3	GND	NA	NA	GND	NA	NA	Power	Ground.
204	F4	HA00_P_CC	NA	NA	NC	NA	NA	NA	NC.
205	F5	HA00_N_CC	NA	NA	NC	NA	NA	NA	NC.
206	F6	GND	NA	NA	GND	NA	NA	Power	Ground.
207	F7	HA04_P	Board to Board Connector 1	204	NC	NA	NA	NA	NC.
208	F8	HA04_N	Board to Board Connector 1	202	NC	NA	NA	NA	NC.
209	F9	GND	NA	NA	GND	NA	NA	Power	Ground.
210	F10	HA08_P	Board to Board Connector 1	153	NC	NA	NA	NA	NC.
211	F11	HA08_N	Board to Board Connector 1	151	NC	NA	NA	NA	NC.
212	F12	GND	NA	NA	GND	NA	NA	Power	Ground.
213	F13	HA12_P	Board to Board Connector 1	150	NC	NA	NA	NA	NC.
214	F14	HA12_N	Board to Board Connector 1	148	NC	NA	NA	NA	NC.
215	F15	GND	NA	NA	NC	NA	NA	Power	Ground.
216	F16	HA15_P	NA	NA	NC	NA	NA	NA	NC.
217	F17	HA15_N	NA	NA	NC	NA	NA	NA	NC.
218	F18	GND	NA	NA	GND	NA	NA	Power	Ground.
219	F19	HA19_P	NA	NA	NC	NA	NA	NA	NC.
220	F20	HA19_N	Board to Board Connector 1	10	NC	NA	NA	NA	NC.
221	F21	GND	NA	NA	GND	NA	NA	Power	Ground.
222	F22	HB02_P	NA	NA	NC	NA	NA	NA	NC.
223	F23	HB02_N	NA	NA	NC	NA	NA	NA	NC.
224	F24	GND	NA	NA	GND	NA	NA	Power	Ground.
225	F25	HB04_P	NA	NA	NC	NA	NA	NA	NC.
226	F26	HB04_N	NA	NA	NC	NA	NA	NA	NC.
227	F27	GND	NA	NA	GND	NA	NA	Power	Ground.
228	F28	HB08_P	NA	NA	NC	NA	NA	NA	NC.
229	F29	HB08_N	NA	NA	NC	NA	NA	NA	NC.
230	F30	GND	NA	NA	GND	NA	NA	Power	Ground.
231	F31	HB12_P	NA	NA	NC	NA	NA	NA	NC.
232	F32	HB12_N	NA	NA	NC	NA	NA	NA	NC.
233	F33	GND	NA	NA	GND	NA	NA	Power	Ground.
234	F34	HB16_P	NA	NA	NC	NA	NA	NA	NC.
235	F35	HB16_N	NA	NA	NC	NA	NA	NA	NC.
236	F36	GND	NA	NA	GND	NA	NA	Power	Ground.

Zynq-Ultrascale+ MPSoC (ZU11/17/19EG) SOM Development Platform Hardware User Guide

Sl.no	FMC+ Connector VITA		Board to Board Connectors			Zynq Ultraascale+ MP SoC (FFVC1760)			Description
	FMC+ Connector Pin No	FMC+ Connector Pin Name	Board to Board Connector Number	Board to Board Connector Pin Number	Board to Board Connector Signal Name (SOM)	MPSoC Bank	MPSoC Pin No	Signal Type/Termination*	
237	F37	HB20_P	NA	NA	NC	NA	NA	NA	NC.
238	F38	HB20_N	NA	NA	NC	NA	NA	NA	NC.
239	F39	GND	NA	NA	GND	NA	NA	Power	Ground.
240	F40	VADJ	NA	NA	VCC_FMC+_ADJ	NA	NA	O, 1.8V Power	Carrier Board Supply Voltage.
241	G1	GND	NA	NA	GND	NA	NA	Power	Ground.
242	G2	CLK1_M2C_P	Board to Board Connector 2	92	PL_B13_LVDS68_L16P_QBC	68	B13	IO, 1.8V	PL Bank68 IO16 differential positive.
243	G3	CLK1_M2C_N	Board to Board Connector 2	94	PL_A12_LVDS68_L16N_QBC	68	A12	IO, 1.8V	PL Bank68 IO16 differential negative.
244	G4	GND	NA	NA	GND	NA	NA	Power	Ground.
245	G5	GND	NA	NA	GND	NA	NA	Power	Ground.
246	G6	LA00_P_CC	Board to Board Connector 2	159	PL_AW9_LVDS67_L1P_DBC	67	AW9	IO, 1.8V	PL Bank67 IO1 differential positive.
247	G7	LA00_N_CC	Board to Board Connector 2	161	PL_AY9_LVDS67_L1N_DBC	67	AY9	IO, 1.8V	PL Bank67 IO1 differential negative.
248	G8	GND	NA	NA	GND	NA	NA	Power	Ground.
249	G9	LA03_P	Board to Board Connector 2	163	PL_BA8_LVDS67_L4P_DBC	67	BA8	IO, 1.8V	PL Bank67 IO4 differential positive.
250	G10	LA03_N	Board to Board Connector 2	165	PL_BA7_LVDS67_L4N_DBC	67	BA7	IO, 1.8V	PL Bank67 IO4 differential negative .
251	G11	GND	NA	NA	GND	NA	NA	Power	Ground.
252	G12	LA08_P	Board to Board Connector 2	155	PL_AW11_LVDS67_L9P	67	AW11	IO, 1.8V	PL Bank67 IO9 differential positive.
253	G13	LA08_N	Board to Board Connector 2	157	PL_AW10_LVDS67_L9N	67	AW10	IO, 1.8V	PL Bank67 IO9 differential negative.
254	G14	GND	NA	NA	GND	NA	NA	Power	Ground.
255	G15	LA12_P	Board to Board Connector 2	175	PL_AR13_LVDS67_L13P_G	67	AR13	IO, 1.8V	PL Bank67 IO13 differential negative .
256	G16	LA12_N	Board to Board Connector 2	177	PL_AR12_LVDS67_L13N_GC	67	AR12	IO, 1.8V	PL Bank67 IO13 differential negative .
257	G17	GND	NA	NA	GND	NA	NA	Power	Ground.
258	G18	LA16_P	Board to Board Connector 2	131	PL_AM11_LVDS67_L17P	67	AM11	IO, 1.8V	PL Bank67 IO17 differential positive.
259	G19	LA16_N	Board to Board Connector 2	133	PL_AN11_LVDS67_L17N	67	AN11	IO, 1.8V	PL Bank67 IO17 differential negative.
260	G20	GND	NA	NA	GND	NA	NA	Power	Ground.
261	G21	LA20_P	Board to Board Connector 2	145	PL_P16_LVDS68_L2P	68	P16	IO, 1.8V	PL Bank68 IO2 differential positive.
262	G22	LA20_N	Board to Board Connector 2	143	PL_N16_LVDS68_L2N	68	N16	IO, 1.8V	PL Bank68 IO2 differential negative.
263	G23	GND	NA	NA	GND	NA	NA	Power	Ground.
264	G24	LA22_P	Board to Board Connector 1	84	PL_G8_LVDS93_L6P_HDGC	93	G8	IO, 1.8V	PL Bank93 IO6 differential positive.
265	G25	LA22_N	Board to Board Connector 1	82	PL_F8_LVDS93_L6N_HDGC	93	F8	IO, 1.8V	PL Bank93 IO6 differential negative.
266	G26	GND	NA	NA	GND	NA	NA	Power	Ground.
267	G27	LA25_P	Board to Board Connector 1	44	PL_G6_LVDS93_L1P	93	G6	IO, 1.8V	PL Bank93 IO1 differential positive.
268	G28	LA25_N	Board to Board Connector 1	42	PL_F6_LVDS93_L1N	93	F6	IO, 1.8V	PL Bank93 IO1 differential positive.
269	G29	GND	NA	NA	GND	NA	NA	Power	Ground.
270	G30	LA29_P	Board to Board Connector 1	16	PL_J9_LVDS93_L3P	93	J9	IO, 1.8V	PL Bank93 IO3 differential positive.
271	G31	LA29_N	Board to Board Connector 1	18	PL_H9_LVDS93_L3N	93	H9	IO, 1.8V	PL Bank93 IO3 differential negative.

Zynq-Ultrascale+ MPSoC (ZU11/17/19EG) SOM Development Platform Hardware User Guide

Sl.no	FMC+ Connector VITA		Board to Board Connectors			Zynq Ultraascale+ MP SoC (FFVC1760)			Description
	FMC+ Connector Pin No	FMC+ Connector Pin Name	Board to Board Connector Number	Board to Board Connector Pin Number	Board to Board Connector Signal Name (SOM)	MPSoC Bank	MPSoC Pin No	Signal Type/Termination*	
272	G32	GND	NA	NA	GND	NA	NA	Power	Ground.
273	G33	LA31_P	Board to Board Connector 1	30	PL_F9_LVDS93_L4P	93	F9	IO, 1.8V	PL Bank93 IO4 differential positive.
274	G34	LA31_N	Board to Board Connector 1	28	PL_E9_LVDS93_L4N	93	E9	IO, 1.8V	PL Bank93 IO4 differential negative.
275	G35	GND	NA	NA	GND	NA	NA	Power	Ground.
276	G36	LA33_P	Board to Board Connector 1	130	PL_C6_LVDS94_L7P_HDGC	94	C6	IO, 1.8V	PL Bank94 IO7 differential positive.
277	G37	LA33_N	Board to Board Connector 1	132	PL_C5_LVDS94_L7N_HDGC	94	C5	IO, 1.8V	PL Bank94 IO7 differential negative.
278	G38	GND	NA	NA	GND	NA	NA	Power	Ground.
279	G39	VADJ	NA	NA	VCC_FMC+_ADJ	NA	NA	O, 1.8V Power	Carrier Board Supply Voltage.
280	G40	GND	NA	NA	GND	NA	NA	Power	Ground.
281	H1	VREF_A_M2C	NA	NA	NC	NA	NA	NA	NC.
282	H2	PRSNT_M2C_L	NA	NA	NA	NA	NA	I,3.3V/10K PU	Module Present Signal. This Pin is connected to 5th pin of IO Expander (U10).
283	H3	GND	NA	NA	GND	NA	NA	Power	Ground.
284	H4	CLK0_M2C_P	Board To Board Connector 2	104	PL_P15_LVDS68_L1P_DBC	68	P15	IO, 1.8V	PL Bank68 IO1 differential positive.
285	H5	CLK0_M2C_N	Board To Board Connector 2	106	PL_N15_LVDS68_L1N_DBC	68	N15	IO, 1.8V	PL Bank68 IO1 differential negative.
286	H6	GND	NA	NA	GND	NA	NA	Power	Ground.
287	H7	LA02_P	Board to Board Connector 2	156	PL_AW8_LVDS67_L3P	67	AW8	IO, 1.8V	PL Bank67 IO3 differential positive.
288	H8	LA02_N	Board to Board Connector 2	158	PL_AY8_LVDS67_L3N	67	AY8	IO, 1.8V	PL Bank67 IO3 differential negative.
289	H9	GND	NA	NA	GND	NA	NA	Power	Ground.
290	H10	LA04_P	Board to Board Connector 2	162	PL_BA6_LVDS67_L5P	67	BA6	IO, 1.8V	PL Bank67 IO5 differential positive.
291	H11	LA04_N	Board to Board Connector 2	160	PL_BB6_LVDS67_L5N	67	BB6	IO, 1.8V	PL Bank67 IO5 differential negative.
292	H12	GND	NA	NA	GND	NA	NA	Power	Ground.
293	H13	LA07_P	Board to Board Connector 2	151	PL_AU11_LVDS67_L8P	67	AU11	IO, 1.8V	PL Bank67 IO8 differential positive.
294	H14	LA07_N	Board to Board Connector 2	153	PL_AV11_LVDS67_L8N	67	AV11	IO, 1.8V	PL Bank67 IO8 differential negative.
295	H15	GND	NA	NA	GND	NA	NA	Power	Ground.
296	H16	LA11_P	Board to Board Connector 2	170	PL_AT11_LVDS67_L12P_GC	67	AT11	IO, 1.8V	PL Bank67 IO12 differential positive.
297	H17	LA11_N	Board to Board Connector 2	172	PL_AT10_LVDS67_L12N_GC	67	AT10	IO, 1.8V	PL Bank67 IO12 differential negative.
298	H18	GND	NA	NA	GND	NA	NA	Power	Ground.
299	H19	LA15_P	Board to Board Connector 2	182	PL_AN12_LVDS67_L16P_QBC	67	AN12	IO, 1.8V	PL Bank67 IO16 differential positive.
300	H20	LA15_N	Board to Board Connector 2	184	PL_AP12_LVDS67_L16N_QBC	67	AP12	IO, 1.8V	PL Bank67 IO16 differential negative.
301	H21	GND	NA	NA	GND	NA	NA	Power	Ground.
302	H22	LA19_P	Board to Board Connector 2	140	PL_AJ14_LVDS67_L24P	67	AJ14	IO, 1.8V	PL Bank67 IO24 differential positive.

Zynq-Ultrascale+ MPSoC (ZU11/17/19EG) SOM Development Platform Hardware User Guide

Sl.no	FMC+ Connector VITA		Board to Board Connectors			Zynq Ultraascale+ MP SoC (FFVC1760)			Description
	FMC+ Connector Pin No	FMC+ Connector Pin Name	Board to Board Connector Number	Board to Board Connector Pin Number	Board to Board Connector Signal Name (SOM)	MPSoC Bank	MPSoC Pin No	Signal Type/Termination*	
303	H23	LA19_N	Board to Board Connector 2	142	PL_AK14_LVDS67_L24N	67	AK14	IO, 1.8V	PL Bank67 IO24 differential negative.
304	H24	GND	NA	NA	GND	NA	NA	Power	Ground.
305	H25	LA21_P	Board to Board Connector 2	139	PL_D13_LVDS68_L15P	68	D13	IO, 1.8V	PL Bank68 IO15 differential positive.
306	H26	LA21_N	Board to Board Connector 2	141	PL_C13_LVDS68_L15N	68	C13	IO, 1.8V	PL Bank68 IO15 differential negative.
307	H27	GND	NA	NA	GND	NA	NA	Power	Ground.
308	H28	LA24_P	Board to Board Connector 1	12	PL_B8_LVDS93_L11P	93	B8	IO, 1.8V	PL Bank93 IO11 differential positive.
309	H29	LA24_N	Board to Board Connector 1	14	PL_A8_LVDS93_L11N	93	A8	IO, 1.8V	PL Bank93 IO11 differential negative.
310	H30	GND	NA	NA	GND	NA	NA	Power	Ground.
311	H31	LA28_P	Board to Board Connector 1	31	PL_B7_LVDS93_L10P	93	B7	IO, 1.8V	PL Bank93 IO10 differential positive.
312	H32	LA28_N	Board to Board Connector 1	33	PL_A7_LVDS93_L10N	93	A7	IO, 1.8V	PL Bank93 IO10 differential negative.
313	H33	GND	NA	NA	GND	NA	NA	Power	Ground.
314	H34	LA30_P	Board to Board Connector 1	58	PL_E7_LVDS93_L7P_HDGC	93	E7	IO, 1.8V	PL Bank93 IO7 differential positive.
315	H35	LA30_N	Board to Board Connector 1	56	PL_D7_LVDS93_L7N_HDGC	93	D7	IO, 1.8V	PL Bank93 IO7 differential negative.
316	H36	GND	NA	NA	GND	NA	NA	Power	Ground.
317	H37	LA32_P	Board to Board Connector 1	91	PL_E5_LVDS94_L2P	94	E5	IO, 1.8V	PL Bank94 IO2 differential positive.
318	H38	LA32_N	Board to Board Connector 1	93	PL_E4_LVDS94_L2N	94	E4	IO, 1.8V	PL Bank94 IO2 differential negative.
319	H39	GND	NA	NA	GND	NA	NA	Power	Ground.
320	H40	VADJ	NA	NA	VCC_FMC+_ADJ	NA	NA	O, 1.8V Power	Carrier Board Supply Voltage.
321	J1	GND	NA	NA	GND	NA	NA	Power	Ground.
322	J2	CLK3_BIDIR_P	NA	NA	NC	NA	NA	NA	NC.
323	J3	CLK3_BIDIR_N	NA	NA	NC	NA	NA	NA	NC.
324	J4	GND	NA	NA	GND	NA	NA	Power	Ground.
325	J5	GND	NA	NA	GND	NA	NA	Power	Ground.
326	J6	HA03_P	Board to Board Connector 1	238	NC	NA	NA	NA	NC.
327	J7	HA03_N	Board to Board Connector 1	236	NC	NA	NA	NA	NC.
328	J8	GND	NA	NA	GND	NA	NA	Power	Ground.
329	J9	HA07_P	Board to Board Connector 1	147	NC	NA	NA	NA	NC.
330	J10	HA07_N	Board to Board Connector 1	149	NC	NA	NA	NA	NC.
331	J11	GND	NA	NA	GND	NA	NA	Power	Ground.
332	J12	HA11_P	Board to Board Connector 1	154	NC	NA	NA	NA	NC.
333	J13	HA11_N	Board to Board Connector 1	152	NC	NA	NA	NA	NC.
334	J14	GND	NA	NA	GND	NA	NA	Power	Ground.
335	J15	HA14_P	NA	NA	NC	NA	NA	NA	NC.
336	J16	HA14_N	NA	NA	NC	NA	NA	NA	NC.
337	J17	GND	NA	NA	GND	NA	NA	Power	Ground.
338	J18	HA18_P	Board to Board Connector 1	172	NC	NA	NA	NA	NC.
339	J19	HA18_N	NA	NA	NC	NA	NA	NA	NC.

Zynq-Ultrascale+ MPSoC (ZU11/17/19EG) SOM Development Platform Hardware User Guide

Sl.no	FMC+ Connector VITA		Board to Board Connectors			Zynq UltraScale+ MP SoC (FFVC1760)			Description
	FMC+ Connector Pin No	FMC+ Connector Pin Name	Board to Board Connector Number	Board to Board Connector Pin Number	Board to Board Connector Signal Name (SOM)	MPSoC Bank	MPSoC Pin No	Signal Type/Termination*	
340	J20	GND	NA	NA	GND	NA	NA	Power	Ground.
341	J21	HA22_P	NA	NA	NC	NA	NA	NA	NC.
342	J22	HA22_N	NA	NA	NC	NA	NA	NA	NC.
343	J23	GND	NA	NA	GND	NA	NA	Power	Ground.
344	J24	HB01_P	NA	NA	NC	NA	NA	NA	NC.
345	J25	HB01_N	NA	NA	NC	NA	NA	NA	NC.
346	J26	GND	NA	NA	GND	NA	NA	Power	Ground.
347	J27	HB07_P	NA	NA	NC	NA	NA	NA	NC.
348	J28	HB07_N	NA	NA	NC	NA	NA	NA	NC.
349	J29	GND	NA	NA	GND	NA	NA	Power	Ground.
350	J30	HB11_P	NA	NA	NC	NA	NA	NA	NC.
351	J31	HB11_N	NA	NA	NC	NA	NA	NA	NC.
352	J32	GND	NA	NA	GND	NA	NA	Power	Ground.
353	J33	HB15_P	NA	NA	NC	NA	NA	NA	NC.
354	J34	HB15_N	NA	NA	NC	NA	NA	NA	NC.
355	J35	GND	NA	NA	GND	NA	NA	Power	Ground.
356	J36	HB18_P	NA	NA	NC	NA	NA	NA	NC.
357	J37	HB18_N	NA	NA	NC	NA	NA	NA	NC.
358	J38	GND	NA	NA	GND	NA	NA	Power	Ground.
359	J39	VIO_B_M2C	NA	NA	NC	NA	NA	NA	NC.
360	J40	GND	NA	NA	GND	NA	NA	Power	Ground.
361	K1	VREF_B_M2C	NA	NA	NC	NA	NA	NA	NC.
362	K2	GND	NA	NA	GND	NA	NA	Power	Ground.
363	K3	GND			GND	NA	NA	Power	Ground.
364	K4	CLK2_BIDIR_P	NA	NA	NA	NA	NA	NA	NA
365	K5	CLK2_BIDIR_N	NA	NA	NA	NA	NA	NA	NA
366	K6	GND	NA	NA	GND	NA	NA	Power	Ground.
367	K7	HA02_P	Board to Board Connector 1	108	NC	NA	NA	NA	NC.
368	K8	HA02_N	Board to Board Connector 1	106	NC	NA	NA	NA	NC.
369	K9	GND	NA	NA	GND	NA	NA	Power	Ground.
370	K10	HA06_P	Board to Board Connector 1	78	NC	NA	NA	NA	NC.
371	K11	HA06_N	Board to Board Connector 1	104	NC	NA	NA	NA	NC.
372	K12	GND	NA	NA	GND	NA	NA	Power	Ground.
373	K13	HA10_P	Board to Board Connector 1	136	NC	NA	NA	NA	NC.
374	K14	HA10_N	Board to Board Connector 1	138	NC	NA	NA	NA	NC.
375	K15	GND	NA	NA	GND	NA	NA	Power	Ground.
376	K16	HA17_P_CC	NA	NA	NC	NA	NA	NA	NC.
377	K17	HA17_N_CC	NA	NA	NC	NA	NA	NA	NC.
378	K18	GND	NA	NA	GND	NA	NA	Power	Ground.

Zynq-Ultrascale+ MPSoC (ZU11/17/19EG) SOM Development Platform Hardware User Guide

Sl.no	FMC+ Connector VITA		Board to Board Connectors			Zynq Ultraascale+ MP SoC (FFVC1760)			Description
	FMC+ Connector Pin No	FMC+ Connector Pin Name	Board to Board Connector Number	Board to Board Connector Pin Number	Board to Board Connector Signal Name (SOM)	MPSoC Bank	MPSoC Pin No	Signal Type/Termination*	
379	K19	HA21_P	NA	NA	NC	NA	NA	NA	NC.
380	K20	HA21_N	NA	NA	NC	NA	NA	NA	NC.
381	K21	GND	NA	NA	GND	NA	NA	Power	Ground.
382	K22	HA23_P	NA	NA	NC	NA	NA	NA	NC.
383	K23	HA23_N	NA	NA	NC	NA	NA	NA	NC.
384	K24	GND	NA	NA	GND	NA	NA	Power	Ground.
385	K25	HB00_P_CC	NA	NA	NC	NA	NA	NA	NC.
386	K26	HB00_N_CC	NA	NA	NC	NA	NA	NA	NC.
387	K27	GND	NA	NA	GND	NA	NA	Power	Ground.
388	K28	HB06_P_CC	NA	NA	NC	NA	NA	NA	NC.
389	K29	HB06_N_CC	NA	NA	NC	NA	NA	NA	NC.
390	K30	GND	NA	NA	GND	NA	NA	Power	Ground.
391	K31	HB10_P	NA	NA	NC	NA	NA	NA	NC.
392	K32	HB10_N	NA	NA	NC	NA	NA	NA	NC.
393	K33	GND	NA	NA	GND	NA	NA	Power	Ground.
394	K34	HB14_P	NA	NA	NC	NA	NA	NA	NC.
395	K35	HB14_N	NA	NA	NC	NA	NA	NA	NC.
396	K36	GND	NA	NA	GND	NA	NA	Power	Ground.
397	K37	HB17_P_CC	NA	NA	NC	NA	NA	NA	NC.
398	K38	HB17_N_CC	NA	NA	NC	NA	NA	NA	NC.
399	K39	GND	NA	NA	GND	NA	NA	Power	Ground.
400	K40	VIO_B_M2C	NA	NA	NC	NA	NA	NA	NC.
401	L1	RES1	NA	NA	NC	NA	NA	NA	NC.
402	L2	GND	NA	NA	GND	NA	NA	Power	Ground.
403	L3	GND	NA	NA	GND	NA	NA	Power	Ground.
404	L4	GBTCLK4_M2C_P	Board to Board Connector 3	B42	GTREFCLK0P_229	229	Y12	I, DIFF	GTH Bank229 differential reference clock0 positive.
405	L5	GBTCLK4_M2C_N	Board to Board Connector 3	B43	GTREFCLK0N_229	229	Y11	I, DIFF	GTH Bank229 differential reference clock0 Negative.
406	L6	GND	NA	NA	GND	NA	NA	Power	Ground.
407	L7	GND	NA	NA	GND	NA	NA	Power	Ground.
408	L8	GBTCLK3_M2C_P	Board to Board Connector 4	A6	GTREFCLK0P_230	230	V12	I, DIFF	GTH Bank230 differential reference clock0 positive.
409	L9	GBTCLK3_M2C_N	Board to Board Connector 4	A7	GTREFCLK0N_230	230	V11	I, DIFF	GTH Bank230 differential reference clock0 negative.
410	L10	GND	NA	NA	GND	NA	NA	Power	Ground.
411	L11	GND	NA	NA	GND	NA	NA	Power	Ground.
412	L12	GBTCLK2_M2C_P	Board to Board Connector 3	C48	GTREFCLK0P_231	231	T12	I, DIFF	GTH Bank231 differential reference clock0 positive.

Zynq-Ultrascale+ MPSoC (ZU11/17/19EG) SOM Development Platform Hardware User Guide

Sl.no	FMC+ Connector VITA		Board to Board Connectors			Zynq Ultraascale+ MP SoC (FFVC1760)			Description
	FMC+ Connector Pin No	FMC+ Connector Pin Name	Board to Board Connector Number	Board to Board Connector Pin Number	Board to Board Connector Signal Name (SOM)	MPSoC Bank	MPSoC Pin No	Signal Type/Termination*	
413	L13	GBTCLK2_M2C_P	Board to Board Connector 3	C49	GTREFCLK0N_231	231	T11	I, DIFF	GTH Bank231 differential reference clock0 Negative.
414	L14	GND	NA	NA	GND	NA	NA	Power	Ground.
415	L15	GND	NA	NA	GND	NA	NA	Power	Ground.
416	L16	SYNC_C2M_P	NA	NA	NC	NA	NA	NA	NC.
417	L17	SYNC_C2M_N	NA	NA	NC	NA	NA	NA	NC.
418	L18	GND	NA	NA	GND	NA	NA	Power	Ground.
419	L19	GND	NA	NA	GND	NA	NA	Power	Ground.
420	L20	REFCLK_C2M_P	NA	NA	NC	NA	NA	NA	NC.
421	L21	REFCLK_C2M_N	NA	NA	NC	NA	NA	NA	NC.
422	L22	GND	NA	NA	GND	NA	NA	Power	Ground.
423	L23	GND	NA	NA	GND	NA	NA	Power	Ground.
424	L24	REFCLK_M2C_P	NA	NA	NC	NA	NA	NA	NC.
425	L25	REFCLK_M2C_N	NA	NA	NC	NA	NA	NA	NC.
426	L26	GND	NA	NA	GND	NA	NA	Power	Ground.
427	L27	GND	NA	NA	GND	NA	NA	Power	Ground.
428	L28	SYNC_M2C_P	NA	NA	NC	NA	NA	NA	NC.
429	L29	SYNC_M2C_N	NA	NA	NC	NA	NA	NA	NC.
430	L30	GND	NA	NA	GND	NA	NA	Power	Ground.
431	L31	GND	NA	NA	GND	NA	NA	Power	Ground.
432	L32	RES2	NA	NA	NC	NA	NA	NA	NC.
433	L33	RES3	NA	NA	NC	NA	NA	NA	NC.
434	L34	GND	NA	NA	GND	NA	NA	Power	Ground.
435	L35	GND	NA	NA	GND	NA	NA	Power	Ground.
436	L36	12POV	NA	NA	VCC_12V_FMC+	NA	NA	O, 12V Power	Carrier Board Supply Voltage.
437	L37	12POV	NA	NA	VCC_12V_FMC+	NA	NA	O, 12V Power	Carrier Board Supply Voltage.
438	L38	GND	NA	NA	GND	NA	NA	Power	Ground.
439	L39	GND	NA	NA	GND	NA	NA	Power	Ground.
440	L40	12POV	NA	NA	VCC_12V_FMC+	NA	NA	O, 12V Power	Carrier Board Supply Voltage.
441	M1	GND	NA	NA	GND	NA	NA	Power	Ground.
442	M2	DP23_M2C_P	Board to Board Connector 4	D16	GTHRXP3_228	228	AA2	I, DIFF	GTH Bank228 channel3 High speed differential receiver positive.
443	M3	DP23_M2C_N	Board to Board Connector 4	D17	GTHRXN3_228	228	AA1	I, DIFF	GTH Bank228 channel3 High speed differential receiver negative.
444	M4	GND	NA	NA	GND	NA	NA	Power	Ground.
445	M5	GND	NA	NA	GND	NA	NA	Power	Ground.
446	M6	DP22_M2C_P	Board to Board Connector 4	C14	GTHRXP2_228	228	AB4	I, DIFF	GTH Bank228 channel2 High speed differential receiver positive.

Zynq-Ultrascale+ MPSoC (ZU11/17/19EG) SOM Development Platform Hardware User Guide

Sl.no	FMC+ Connector VITA		Board to Board Connectors			Zynq Ultraascale+ MP SoC (FFVC1760)			Description
	FMC+ Connector Pin No	FMC+ Connector Pin Name	Board to Board Connector Number	Board to Board Connector Pin Number	Board to Board Connector Signal Name (SOM)	MPSoC Bank	MPSoC Pin No	Signal Type/Termination*	
447	M7	DP22_M2C_N	Board to Board Connector 4	C15	GTHRXN2_228	228	AB3	I, DIFF	GTH Bank228 channel2 High speed differential receiver negative.
448	M8	GND	NA	NA	GND	NA	NA	Power	Ground.
449	M9	GND	NA	NA	GND	NA	NA	Power	Ground.
450	M10	DP21_M2C_P	Board to Board Connector 4	D13	GTHRXP1_228	228	AC2	I, DIFF	GTH Bank228 channel1 High speed differential receiver positive.
451	M11	DP21_M2C_N	Board to Board Connector 4	D12	GTHRXN1_228	228	AC1	I, DIFF	GTH Bank228 channel1 High speed differential receiver Negative.
452	M12	GND	NA	NA	GND	NA	NA	Power	Ground.
453	M13	GND	NA	NA	GND	NA	NA	Power	Ground.
454	M14	DP20_M2C_P	Board to Board Connector 4	C19	GTHRXP0_228	228	AD4	I, DIFF	GTH Bank228 channel0 High speed differential receiver positive.
455	M15	DP20_M2C_N	Board to Board Connector 4	C18	GTHRXN0_228	228	AD3	I, DIFF	GTH Bank228 channel0 High speed differential receiver negative.
456	M16	GND	NA	NA	GND	NA	NA	Power	Ground.
457	M17	GND	NA	NA	GND	NA	NA	Power	Ground.
458	M18	DP14_C2M_P	Board to Board Connector 4	A18	GTHTXP2_230	230	N6	O, DIFF	GTH Bank230 channel2 High speed differential transmitter positive.
459	M19	DP14_C2M_N	Board to Board Connector 4	A19	GTHTXN2_230	230	N5	O, DIFF	GTH Bank230 channel2 High speed differential transmitter negative.
460	M20	GND	NA	NA	GND	NA	NA	Power	Ground.
461	M21	GND	NA	NA	GND	NA	NA	Power	Ground.
462	M22	DP15_C2M_P	Board to Board Connector 4	B12	GTHTXP3_230	230	M8	O, DIFF	GTH Bank230 channel3 High speed differential transmitter positive.
463	M23	DP15_C2M_N	Board to Board Connector 4	B13	GTHTXN3_230	230	M7	O, DIFF	GTH Bank230 channel3 High speed differential transmitter negative.
464	M24	GND	NA	NA	GND	NA	NA	Power	Ground.
465	M25	GND	NA	NA	GND	NA	NA	Power	Ground.
466	M26	DP16_C2M_P	Board to Board Connector 3	A44	GTHTXP0_229	229	W6	O, DIFF	GTH Bank229 channel0 High speed differential Transmitter positive.
467	M27	DP16_C2M_N	Board to Board Connector 3	A45	GTHTXN0_229	229	W5	O, DIFF	GTH Bank229 channel0 High speed differentialTransmitter Negative.
468	M28	GND	NA	NA	GND	NA	NA	Power	Ground.
469	M29	GND	NA	NA	GND	NA	NA	Power	Ground.
470	M30	DP17_C2M_P	Board to Board Connector 3	B46	GTHTXP1_229	229	V8	O, DIFF	GTH Bank229 channel1 High speed differential Transmitter positive.
471	M31	DP17_C2M_N	Board to Board Connector 3	B47	GTHTXP2_229	229	V7	O, DIFF	GTH Bank229 channel1 High speed differentialTransmitter Negative.
472	M32	GND	NA	NA	GND	NA	NA	Power	Ground.

Zynq-Ultrascale+ MPSoC (ZU11/17/19EG) SOM Development Platform Hardware User Guide

Sl.no	FMC+ Connector VITA		Board to Board Connectors			Zynq Ultraascale+ MP SoC (FFVC1760)			Description
	FMC+ Connector Pin No	FMC+ Connector Pin Name	Board to Board Connector Number	Board to Board Connector Pin Number	Board to Board Connector Signal Name (SOM)	MPSoC Bank	MPSoC Pin No	Signal Type/Termination*	
473	M33	GND	NA	NA	GND	NA	NA	Power	Ground.
474	M34	DP18_C2M_P	Board to Board Connector 3	A52	GTHTXP2_229	229	U6	O, DIFF	GTH Bank229 channel2 High speed differential transmitter positive.
475	M35	DP18_C2M_N	Board to Board Connector 3	A53	GTHTXN2_229	229	U5	O, DIFF	GTH Bank229 channel2 High speed differential transmitter negative.
476	M36	GND	NA	NA	GND	NA	NA	Power	Ground.
477	M37	GND	NA	NA	GND	NA	NA	Power	Ground.
478	M38	DP19_C2M_P	Board to Board Connector 3	A48	GTHTXP3_229	229	T8	O, DIFF	GTH Bank229 channel3 High speed differential transmitter positive.
479	M39	DP19_C2M_N	Board to Board Connector 3	A49	GTHTXN3_229	229	T7	O, DIFF	GTH Bank229 channel3 High speed differential transmitter negative.
480	M40	GND	NA	NA	GND	NA	NA	Power	Ground.
481	Y1	GND	NA	NA	GND	NA	NA	Power	Ground.
482	Y2	DP23_C2M_P	Board to Board Connector 4	C6	GTHTXP3_228	228	Y8	O, DIFF	GTH Bank228 channel3 High speed differential transmitter Positive.
483	Y3	DP23_C2M_N	Board to Board Connector 4	C7	GTHTXN3_228	228	Y7	O, DIFF	GTH Bank228 channel3 High speed differential transmitter negative
484	Y4	GND	NA	NA	GND	NA	NA	Power	Ground.
485	Y5	GND	NA	NA	GND	NA	NA	Power	Ground.
486	Y6	DP21_C2M_P	Board to Board Connector 4	D4	GTHTXP1_228	228	AB8	O, DIFF	GTH Bank228 channel1 High speed differential Transmitter positive.
487	Y7	DP21_C2M_N	Board to Board Connector 4	D5	GTHTXN1_228	228	AB7	O, DIFF	GTH Bank228 channel1 High speed differential Transmitter Negative.
488	Y8	GND	NA	NA	GND	NA	NA	Power	Ground.
489	Y9	GND	NA	NA	GND	NA	NA	Power	Ground.
490	Y10	DP10_M2C_P	Board to Board Connector 3	C45	GTHRXP2_231	231	J2	I, DIFF	GTH Bank231 channel2 High speed differential receiver positive.
491	Y11	DP10_M2C_N	Board to Board Connector 3	C44	GTHRXN2_231	231	J1	I, DIFF	GTH Bank231 channel2 High speed differential receiver Negative.
492	Y12	GND	NA	NA	GND	NA	NA	Power	Ground.
493	Y13	GND	NA	NA	GND	NA	NA	Power	Ground.
494	Y14	DP12_M2C_P	Board to Board Connector 4	B17	GTHRXP0_230	230	T4	I, DIFF	GTH Bank230 channel0 High speed differential receiver positive.
495	Y15	DP12_M2C_N	Board to Board Connector 4	B16	GTHRXN0_230	230	T3	I, DIFF	GTH Bank230 channel0 High speed differential receiver negative.
496	Y16	GND	NA	NA	GND	NA	NA	Power	Ground.
497	Y17	GND	NA	NA	GND	NA	NA	Power	Ground.
498	Y18	DP14_M2C_P	Board to Board Connector 4	B9	GTHRXP2_230	230	P4	I, DIFF	GTH Bank230 channel2 High speed differential receiver positive.

Zynq-Ultrascale+ MPSoC (ZU11/17/19EG) SOM Development Platform Hardware User Guide

Sl.no	FMC+ Connector VITA		Board to Board Connectors			Zynq Ultraascale+ MP SoC (FFVC1760)			Description
	FMC+ Connector Pin No	FMC+ Connector Pin Name	Board to Board Connector Number	Board to Board Connector Pin Number	Board to Board Connector Signal Name (SOM)	MPSoC Bank	MPSoC Pin No	Signal Type/Termination*	
499	Y19	DP14_M2C_N	Board to Board Connector 4	B8	GTHRXN2_230	230	P3	I, DIFF	GTH Bank230 channel2 High speed differential receiver negative.
500	Y20	GND	NA	NA	GND	NA	NA	Power	Ground.
501	Y21	GND	NA	NA	GND	NA	NA	Power	Ground.
502	Y22	DP15_M2C_P	Board to Board Connector 4	B5	GTHRXP3_230	230	N2	I, DIFF	GTH Bank230 channel3 High speed differential receiver positive.
503	Y23	DP15_M2C_N	Board to Board Connector 4	B4	GTHRXN3_230	230	N1	I, DIFF	GTH Bank230 channel3 High speed differential receiver negative.
504	Y24	GND	NA	NA	GND	NA	NA	Power	Ground.
505	Y25	GND	NA	NA	GND	NA	NA	Power	Ground.
506	Y26	DP11_C2M_P	Board to Board Connector 3	D58	GTHTXP3_231	231	H4	O, DIFF	GTH Bank231 channel3 High speed differential Transmitter positive.
507	Y27	DP11_C2M_N	Board to Board Connector 3	D59	GTHTXN3_231	231	H3	O, DIFF	GTH Bank231 channel3 High speed differential Transmitter Negative.
508	Y28	GND	NA	NA	GND	NA	NA	Power	Ground.
509	Y29	GND	NA	NA	GND	NA	NA	Power	Ground.
510	Y30	DP13_C2M_P	Board to Board Connector 4	A14	GTHTXP1_230	230	P8	O, DIFF	GTH Bank230 channel1 High speed differential transmitter positive.
511	Y31	DP13_C2M_N	Board to Board Connector 4	A15	GTHTXN1_230	230	P7	O, DIFF	GTH Bank230 channel1 High speed differential transmitter negative.
512	Y32	GND	NA	NA	GND	NA	NA	Power	Ground.
513	Y33	GND	NA	NA	GND	NA	NA	Power	Ground.
514	Y34	DP17_M2C_P	Board to Board Connector 3	A56	GTHRXP1_229	229	W2	I, DIFF	GTH Bank229 channel1 High speed differential receiver positive.
515	Y35	DP17_M2C_N	Board to Board Connector 3	A57	GTHRXN1_229	229	W1	I, DIFF	GTH Bank229 channel1 High speed differential receiver Negative.
516	Y36	GND	NA	NA	GND	NA	NA	Power	Ground.
517	Y37	GND	NA	NA	GND	NA	NA	Power	Ground.
518	Y38	DP19_M2C_P	Board to Board Connector 3	B58	GTHRXP3_229	229	U2	I, DIFF	GTH Bank229 channel3 High speed differential receiver positive.
519	Y39	DP19_M2C_N	Board to Board Connector 3	B59	GTHRXN3_229	229	U1	I, DIFF	GTH Bank229 channel3 High speed differential receiver negative.
520	Y40	GND	NA	NA	GND	NA	NA	Power	Ground.
521	Z1	HSPC_PRSENT_M2C_L	NA	NA	NA	NA	NA	I,3.3V/10K PU	FMC+ Module Present Signal. This Pin is connected to 6th pin of IO Expander (U10).
522	Z2	GND	NA	NA	GND	NA	NA	Power	Ground.
523	Z3	GND	NA	NA	GND	NA	NA	Power	Ground.
524	Z4	DP22_C2M_P	Board to Board Connector 4	C11	GTHTXP2_228	228	AA6	O, DIFF	GTH Bank228 channel2 High speed differential transmitter positive.

Zynq-Ultrascale+ MPSoC (ZU11/17/19EG) SOM Development Platform Hardware User Guide

Sl.no	FMC+ Connector VITA		Board to Board Connectors			Zynq Ultraascale+ MP SoC (FFVC1760)			Description
	FMC+ Connector Pin No	FMC+ Connector Pin Name	Board to Board Connector Number	Board to Board Connector Pin Number	Board to Board Connector Signal Name (SOM)	MPSoC Bank	MPSoC Pin No	Signal Type/Termination*	
525	Z5	DP22_C2M_N	Board to Board Connector 4	C10	GTHTXN2_228	228	AA5	O, DIFF	GTH Bank228 channel2 High speed differential transmitter negative.
526	Z6	GND	NA	NA	GND	NA	NA	Power	Ground.
527	Z7	GND	NA	NA	GND	NA	NA	Power	Ground.
528	Z8	DP20_C2M_P	Board to Board Connector 4	C2	GTHTXP0_228	228	AC6	O, DIFF	GTH Bank228 channel0 High speed differential transmitter positive.
529	Z9	DP20_C2M_N	Board to Board Connector 4	C3	GTHTXN0_228	228	AC5	O, DIFF	GTH Bank228 channel0 High speed differential transmitter negative.
530	Z10	GND	NA	NA	GND	NA	NA	Power	Ground.
531	Z11	GND	NA	NA	GND	NA	NA	Power	Ground.
532	Z12	DP11_M2C_P	Board to Board Connector 3	D47	GTHRXP3_231	231	G2	I, DIFF	GTH Bank231 channel3 High speed differential receiver positive.
533	Z13	DP11_M2C_N	Board to Board Connector 3	D46	GTHRXN3_231	231	G1	I, DIFF	GTH Bank231 channel3 High speed differential receiver Negative.
534	Z14	GND	NA	NA	GND	NA	NA	Power	Ground.
535	Z15	GND	NA	NA	GND	NA	NA	Power	Ground.
536	Z16	DP13_M2C_P	Board to Board Connector 4	A3	GTHRXP1_230	230	R2	I, DIFF	GTH Bank230 channel1 High speed differential receiver positive.
537	Z17	DP13_M2C_N	Board to Board Connector 4	A2	GTHRXN1_230	230	R1	I, DIFF	GTH Bank230 channel1 High speed differential receiver negative.
538	Z18	GND	NA	NA	GND	NA	NA	Power	Ground.
539	Z19	GND	NA	NA	GND	NA	NA	Power	Ground.
540	Z20	GBTCLK5_M2C_P	Board to Board Connector 4	D9	GTREFCLK0P_228	228	AB12	I, DIFF	GTH Bank228 differential reference clock0 positive.
541	Z21	GBTCLK5_M2C_N	Board to Board Connector 4	D8	GTREFCLK0N_228	228	AB11	I, DIFF	GTH Bank228 differential reference clock0 negative.
542	Z22	GND	NA	NA	GND	NA	NA	Power	Ground.
543	Z23	GND	NA	NA	GND	NA	NA	Power	Ground.
544	Z24	DP10_C2M_P	Board to Board Connector 3	D54	GTHTXP2_231	231	J6	O, DIFF	GTH Bank231 channel2 High speed differential Transmitter positive.
545	Z25	DP10_C2M_N	Board to Board Connector 3	D55	GTHTXN2_231	231	J5	O, DIFF	GTH Bank231 channel2 High speed differential Transmitter Negative.
546	Z26	GND	NA	NA	GND	NA	NA	Power	Ground.
547	Z27	GND	NA	NA	GND	NA	NA	Power	Ground.
548	Z28	DP12_C2M_P	Board to Board Connector 4	A10	GTHTXP0_230	230	R6	O, DIFF	GTH Bank230 channel0 High speed differential transmitter positive.
549	Z29	DP12_C2M_N	Board to Board Connector 4	A11	GTHTXN0_230	230	R5	O, DIFF	GTH Bank230 channel0 High speed differential transmitter negative.
550	Z30	GND	NA	NA	GND	NA	NA	Power	Ground.

Sl.no	FMC+ Connector VITA		Board to Board Connectors			Zynq Ultraascale+ MP SoC (FFVC1760)			Description
	FMC+ Connector Pin No	FMC+ Connector Pin Name	Board to Board Connector Number	Board to Board Connector Pin Number	Board to Board Connector Signal Name (SOM)	MPSoC Bank	MPSoC Pin No	Signal Type/Termination*	
551	Z31	GND	NA	NA	GND	NA	NA	Power	Ground.
552	Z32	DP16_M2C_P	Board to Board Connector 3	B50	GTHRXP0_229	229	Y4	I, DIFF	GTH Bank229 channel0 High speed differential receiver positive.
553	Z33	DP16_M2C_N	Board to Board Connector 3	B51	GTHRXN0_229	229	Y3	I, DIFF	GTH Bank229 channel0 High speed differential receiver Negative.
554	Z34	GND	NA	NA	GND	NA	NA	Power	Ground.
555	Z35	GND	NA	NA	GND	NA	NA	Power	Ground.
556	Z36	DP18_M2C_P	Board to Board Connector 3	B54	GTHRXP2_229	229	V4	I, DIFF	GTH Bank229 channel2 High speed differential receiver positive.
557	Z37	DP18_M2C_N	Board to Board Connector 3	B55	GTHRXN2_229	229	V3	I, DIFF	GTH Bank229 channel2 High speed differential receiver negative.
558	Z38	GND	NA	NA	GND	NA	NA	Power	Ground.
559	Z39	GND	NA	NA	GND	NA	NA	Power	Ground.
560	Z40	3P3V	NA	NA	VCC_3V3_FMC+	NA	NA	O, 3.3V Power	Carrier Board Supply Voltage.

Note:

* FMC+ connector supports VADJ 1.8V and 1.2V. By default, VADJ is set to 1.8V. Contact iWave for further details.

* If VCC_FMC+_ADJ voltage changed from default value 1.8 to 1.2V, Please make sure that SOM concern IO voltage also to be modified to avoid IO conflict.

*IO Type of IOs originating from ZU19/17/11 MPSoC is configurable. Hence for exact IO type configuration options, refer Xilinx ZU19/17/11 MPSoC datasheet.

2.6 Additional Features

2.6.1 Clock Synthesizers

The Zynq Ultrascale+ MPSoC (ZU11/17/19EG) Carrier board supports two 10-output Clock Synthesizer “SI5341B-D-GM” for on board clock distribution. This Clock Generator outputs are connected to PS-GTR, PL-GTH and PL-GTY Transceiver Banks Reference Clock on Board to Board Connectors through 0.01uF AC coupling capacitors. An external 48MHz crystal is connected to this Clock Synthesizer for reference. This Clock Synthesizer supports from 100 Hz to 1028 MHz clock output and configurable through PS I2C0.

Table 18: Clock Synthesizer 1 Output Clocks

Pin No	Pin Name	Signal Name	Programmed Frequency	Connected To
23	OUT0b	PS_MGTREFCLK3N_505	125 MHz.	B2B-2 220 th pin.
24	OUT0	PS_MGTREFCLK3P_505		B2B-2 218 th pin.
27	OUT1b	GTREFCLK0N_227	156.25 MHz	B2B-2 190 th pin.
28	OUT1	GTREFCLK0P_227		B2B-2 188 th pin.
30	OUT2b	PS_MGTREFCLK1N_505	27 MHz.	B21-1 169 th pin.
31	OUT2	PS_MGTREFCLK1P_505		B2B-1 171 th pin.
34	OUT3b	PS_MGTREFCLK2N_505	52 MHz.	B2B-2 232 th pin.
35	OUT3	PS_MGTREFCLK2P_505		B2B-2 230 th pin.
37	OUT4b	PCIe_REFCLKn	100 MHz.	PClex 4 connector A14 th pin.
38	OUT4	PCIe_REFCLKP		PClex 4 connector A13 th pin.
41	OUT5b	PS_MGTREFCLK0N_505	100 MHz.	B2B-1 75 th pin.
42	OUT5	PS_MGTREFCLK0P_505		B2B-1 77 th pin.
44	OUT6b	GTREFCLK1N_224	156.25 MHz	B2B-1 66 th pin.
45	OUT6	GTREFCLK1P_224		B2B-1 64 th pin.
50	OUT7b	GTREFCLK1N_225	156.25 MHz	B2B-1 160 th pin.
51	OUT7	GTREFCLK1P_225		B2B-1 158 th pin.
53	OUT8b	GTREFCLK1N_226	148.5 MHz	B2B-1 220 th pin.
54	OUT8	GTREFCLK1P_226		B2B-1 218 th pin.
58	OUT9b	GTREFCLK1N_227	148.5 MHz	B2B-2 225 th pin.
59	OUT9	GTREFCLK1P_227		B2B-2 223 th pin.

Table 19 Clock Synthesizer 2 Output Clocks

Pin No	Pin Name	Signal Name	Programmed Frequency	Connected To
23	OUT0b	GTREFCLK1N_231	156.25 MHz	B2B-3 A1 st pin.
24	OUT0	GTREFCLK1P_231		B2B-3 A2 nd pin.
27	OUT1b	GTREFCLK1N_131	156.25 MHz	B2B-3 A20 th pin.
28	OUT1	GTREFCLK1P_131		B2B-3 A21 st pin.
30	OUT2b	GTREFCLK1N_130	156.25 MHz	B2B-3 C16 th pin.
31	OUT2	GTREFCLK1P_130		B2B-3 C17 th pin.
34	OUT3b	GTREFCLK1N_230	156.25 MHz	B2B-4 B1 st pin.
35	OUT3	GTREFCLK1P_230		B2B-4 B2 nd pin.
37	OUT4b	GTREFCLK0N_131	100 MHz	B2B-3 B18 th pin.
38	OUT4	GTREFCLK0P_131		B2B-3 B19 th pin.
41	OUT5b	GTREFCLK1N_228	156.25 MHz	B2B-4 D19 th pin.
42	OUT5	GTREFCLK1P_228		B2B-4 D20 th pin.
44	OUT6b	GTREFCLK1N_128	156.25 MHz	B2B-3 D38 th pin.
45	OUT6	GTREFCLK1P_128		B2B-3 D39 th pin.
50	OUT7b	GTREFCLK1N_129	156.25 MHz	B2B-3 B35 th pin.
51	OUT7	GTREFCLK1P_129		B2B-3 B34 th pin.
53	OUT8b	GTREFCLK1N_229	156.25 MHz	B2B-3 A59 th pin.
54	OUT8	GTREFCLK1P_229		B2B-3 A60 th pin.
58	OUT9b	GTREFCLK0P_128	100 MHz	B2B-3 D2 nd pin
59	OUT9	GTREFCLK0N_128		B2B-3 D3 rd pin.



ZU19/17/11-DevKit-Carrier Board Clock Tree

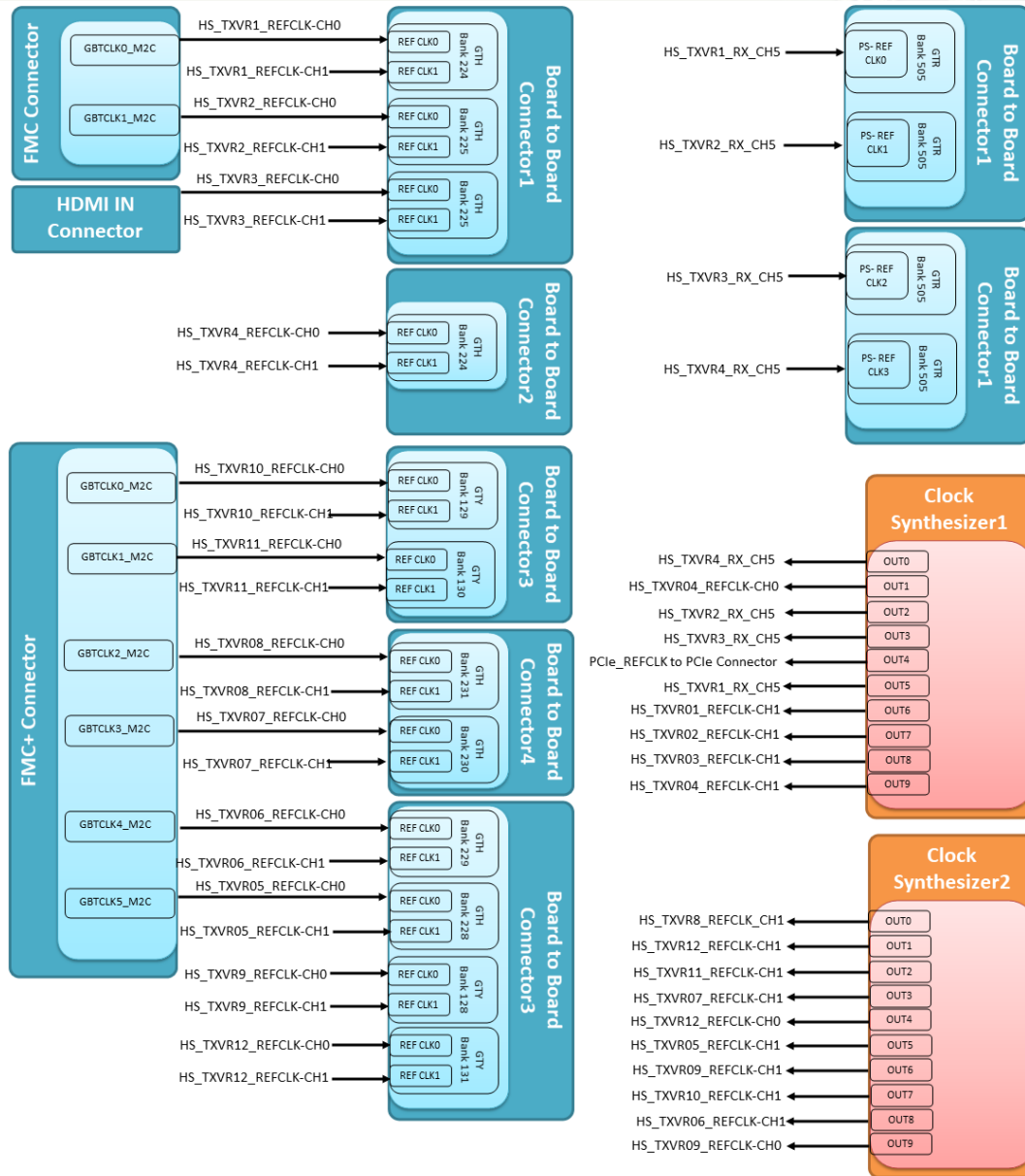

Figure 31: Clock Tree

2.6.2 JTAG Connector

A Standard Xilinx 14-pin JTAG Header is available in Zynq Ultrascale+ MPSoC (ZU11/17/19EG) Carrier board for debug purpose. JTAG signals from Board to Board connector2 is directly connected to JTAG Header (J8) and same JTAG signals are also connected to FMC+ & FMC connector. JTAG-HS2/ JTAG-HS3 programming cable can be plugged to this JTAG Header for programming and debugging purpose. This JTAG Header (J8) is physically located at the top of the board as shown below.

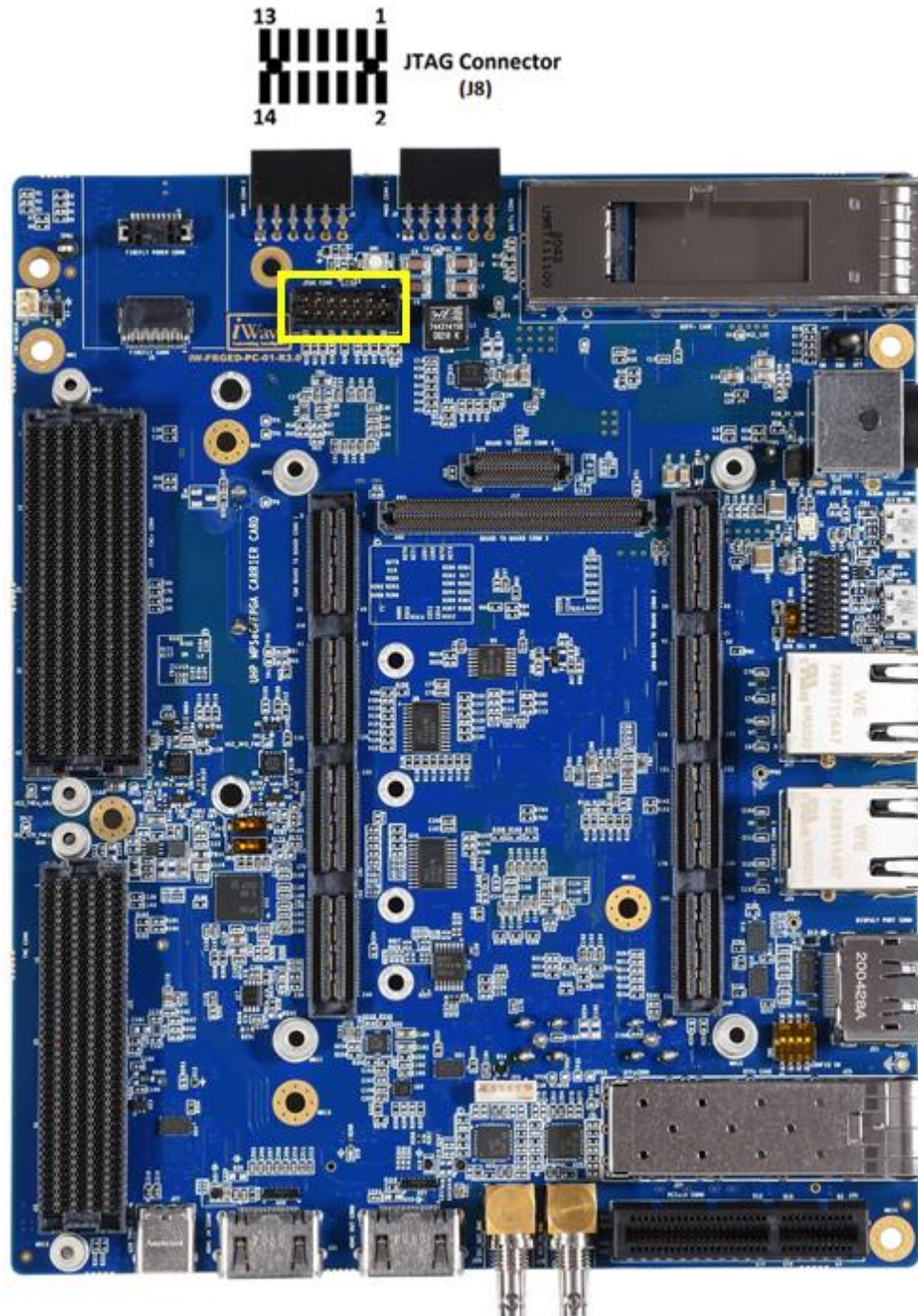

Figure 32: JTAG Connector

Table 20: JTAG Header Pin Assignment

Pin No	Signal Name	Signal Type/ Termination	Description
1	NC	-	Not Connected
2	VCC_3V3	O, 3.3V Power	3V3 Supply Voltage.
3	GND	Power	Ground
4	JTAG_TMS	I, 3V3 LVCMOS/ 49.9K PU	JTAG test mode select.
5	GND	Power	Ground
6	JTAG_TCK	I, 3V3 LVCMOS/ 49.9K PU	JTAG test Clock
7	GND	Power	Ground
8	JTAG_TDO	O,3V3 LVCMOS/ 49.9K PU	JTAG test data output.
9	GND	Power	Ground
10	JTAG_TDI	I, 3V3 LVCMOS	JTAG test data input
11	GND	Power	Ground
12	NC	-	Not Connected
13	GND	Power	Ground
14	JTAG_TRSTB	-	Not Connected

2.6.3 IO Expanders

The Zynq Ultrascale+ MPSoC (ZU11/17/19EG) Carrier board supports three GPIO 16-Bit port Expander. Refer below table for IO Expander pin mapping.

Table 21 IO EXPANDER 1 Output

Pin No	Pin Name	Signal Name	Signal Type / Termination	Description
IO EXPANDER 1 (TCA6416APWR) - I2C address : 0x20				
4	P00	IOEXP_P00_SFP_TFAULT	I, 3.3V CMOS/ 4.7K PU	Connected to SFP+
5	P01	IOEXP_P01_SFP_RX_LOS	I, 3.3V CMOS/ 4.7K PU	Connected to SFP+
6	P02	IOEXP_P02_SFP_MOD_ABS	I, 3.3V CMOS/ 4.7K PU	Connected to SFP+
7	P03	IOEXP_P03_SFP_RS1	I, 3.3V CMOS/ 4.7K PU	Connected to SFP+
8	P04	IOEXP_P04_SFP_RS0	O, 3.3V CMOS/ 4.7K PU	Connected to SFP+
9	P05	IOEXP_P05_SFP_TDIS	O, 3.3V CMOS/ 4.7K PD	Connected to SFP+
10	P06	IOEXP_P07_SDI_IN_CD_INT	I, 3.3V CMOS	Connected to SDI Video IN
11	P07	IOEXP_P10_SDI_CD_INT	I, 3.3V CMOS	Connected to SDI VIDEO OUT
13	P10	IOEXP_P11_MUX_SEL1	O, 3.3V CMOS	Connected to MUX Selection Switch
14	P11	IOEXP_P12_MUX_SEL2	O, 3.3V CMOS	Connected to MUX Selection Switch
15	P12	IOEXP_P13_MUX_SEL3	O, 3.3V CMOS	Connected to MUX Selection Switch
16	P13	IOEXP_P14_MUX_SEL4	O, 3.3V CMOS	Connected to MUX Selection Switch
17	P14	B_IO_EXP_INT2	I, 3.3V CMOS/ 4.7K PU	Connected to IO EXPANDER 2
18	P15	B_IO_EXP_INT3	I, 3.3V CMOS/ 4.7K PU	Connected to IO EXPANDER 3
19	P16	IOEXP_FMC_LA16P	IO, 1.8V CMOS	Connected to FMC connector G18th pin
20	P17	OEXP_HDMI_TX_CEC	I, 3.3V CMOS	Connected from HDMI OUT

Table 22 IO EXPANDER 2 Output

Pin No	Pin Name	Signal Name	Signal Type / Termination	Description
IO EXPANDER 2 (TCA6416APWR)- I2C address: 0x21				
4	P00	IOEXP_P00_Q_MODESEL	O, 3.3V CMOS/ 4.7K PD	Connected to QSFP28 Connector
5	P01	IOEXP_P01_Q_RESETL	O, 3.3V CMOS/ 4.7K PU	Connected to QSFP28 Connector
6	P02	IOEXP_P02_Q_LPMODE	O, 3.3V CMOS/ 4.7K PD	Connected to QSFP28 Connector
7	P03	IOEXP_P03_Q_INTL	I, 3.3V CMOS/ 4.7K PU	Connected to QSFP28 Connector
8	P04	IOEXP_P04_Q_MODPRSL	I, 3.3V CMOS/ 4.7K PU	Connected to QSFP28 Connector
9	P05	IOEXP_P05_F_RESETL	O, 3.3V CMOS/ 4.7K PU	Connected to FireFly Power Connector
10	P06	IOEXP_P06_F_MODESEL	O, 3.3V CMOS/ 4.7K PU	Connected to FireFly Power Connector
11	P07	IOEXP_P07_F_INTL	I, 3.3V CMOS/ 4.7K PU	Connected to FireFly Power Connector
13	P10	IOEXP_P10_F_MODPRS	I, 3.3V CMOS/ 4.7K PU	Connected to FireFly Power Connector
14	P11	IOEXP_P11_HDMI_TX_OE	O, 3.3V CMOS	Connected to IO HDMI OUT
15	P12	IOEXP_HDMI_RX_CEC_SINK	I, 3.3V CMOS	Connected to IO HDMI OUT
16	P13	NC	NC	NC.
17	P14	B_M2_PCI_RST#	O, 3.3V CMOS/ 4.7K PU	Connected to M.2 PCIe Connector
18	P15	B_M2_PCI_WAK#	I, 3.3V CMOS/ 4.7K PU	Connected to M.2 PCIe Connector
19	P16	B_PCI_CLKREQ#	I, 3.3V CMOS/ 4.7K PU	Connected to PCIe 4 Connector
20	P17	NC	NC	NC.

Table 23 IO EXPANDER 3 Output

Pin No	Pin Name	Signal Name	Signal Type / Termination	Description
IO EXPANDER 3 (TCA9535PWR)- I2C address : 0x23				
4	P00	B_FMC_PR_M2C_L	I, 3.3V CMOS/ 10K PU	Connected to FMC connector
5	P01	B_FMC+_PR_M2C_L	I, 3.3V CMOS/ 10K PU	Connected to FMC+ connector
6	P02	B_HSPC_PR_SNT_M2C_L	I, 3.3V CMOS/ 10K PU	Connected to FMC+ connector
7	P03	EN_VCC_12V_FMC	O, 3.3V CMOS/ 10K PD	Connected to FMC Power
8	P04	EN_VCC_3V3_FMC	O, 3.3V CMOS/ 1K PD	Connected to FMC Power
9	P05	EN_VCC_FMC_ADJ	O, 3.3V CMOS/ 10K PD	Connected to FMC Power
10	P06	EN_VCC_FMC+_ADJ	O, 3.3V CMOS/ 10K PD	Connected to FMC+ Power
11	P07	B_PCI/SATA_CONFIG	O, 3.3V CMOS/ 10K PU	Connected to PCIe 4 Connector
13	P10	EN_VCC_12V_FMC+	O, 3.3V CMOS/ 10K PD	Connected to FMC+ Power
14	P11	EN_VCC_3V3_FMC+	O, 3.3V CMOS/ 1K PD	Connected to FMC+ Power
15	P12	B_FMC_CLK_DIR	I, 3.3V CMOS	Connected to FMC connector
16	P13	B_FMC+_CLK_DIR	I, 3.3V CMOS	Connected to FMC+ connector
17	P14	B_FMC_PG_C2M	O, 3.3V CMOS/ 10K PD	Connected to FMC connector
18	P15	B_FMC+_PG_C2M	O, 3.3V CMOS/ 10K PD	Connected to FMC+ connector
19	P16	B_FMC_PG_M2C	I, 3.3V CMOS/ 10K PD	Connected to FMC connector
20	P17	B_FMC+_PG_M2C	I, 3.3V CMOS/ 10K PD	Connected to FMC+ connector

2.6.4 I2C Tree

The Zynq Ultrascale+ MPSoC (ZU11/17/19EG) Carrier board supports one 4 channel I2C Bus Switch (PI4MSD5V9546ALEX). I2C tree shown below.

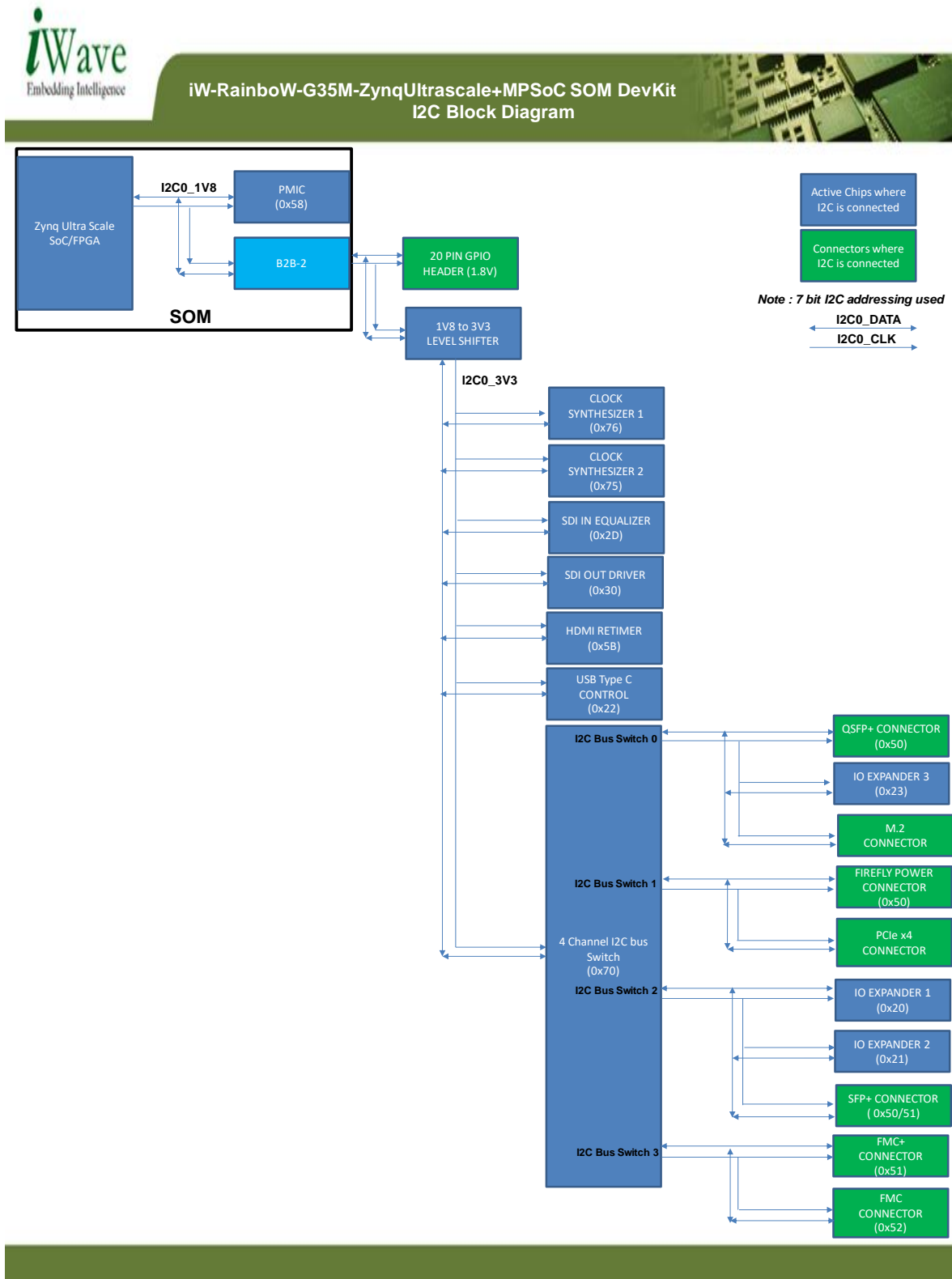

Figure 33 I2C Tree

2.6.5 GPIO Header

The Zynq Ultrascale+ MPSoC (ZU11/17/19EG) Carrier board supports GPIO Header (J15) for General Purpose. This Header signals are directly connected from Board to Board 1 & 2 connectors. This header supports I2C0, UART1, SPI0, CAN1 and PS GPIOs. This GPIO Header (J15) is physically located at the top of the board as shown below.

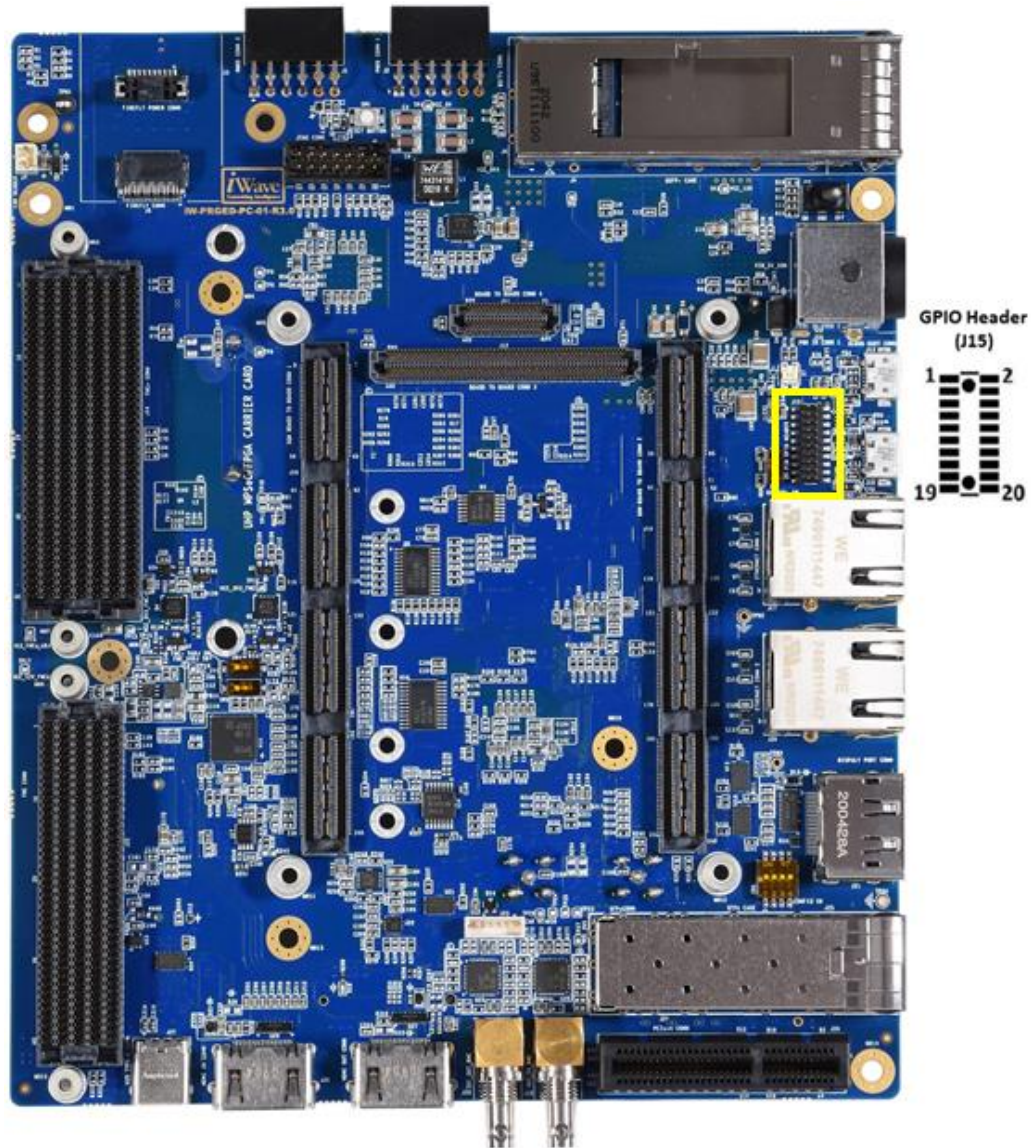

Figure 34: GPIO Header

Table 24: GPIO Header Pin Assignment

Pin No	Signal Name	Signal Type/ Termination	Description
1	VCC_1V8	O, 1.8V Power	1V8 Supply Voltage.
2	VCC_5V	O, 5V Power	5V Supply Voltage.
3	CAN1_RX(PS_MIO41_501)	I, 1.8V LVCMOS	CAN1 Receive data. Same pin can be configured as General Purpose Input/Output if required. This Pin is connected to 211 th pin of Board to Board Connector1 (J10).

Pin No	Signal Name	Signal Type/ Termination	Description
4	I2C0_SDA(PS_MIO11_500)	IO, 1.8V OD/ 4.7K PU	I2C0 data. This Pin is connected to 46 th pin of Board to Board Connector2 (J11).
5	CAN1_TX(PS_MIO40_501)	O, 1.8V LVCMOS	CAN1 Transmit data. Same pin can be configured as General Purpose Input/Output if required. This Pin is connected to 213 rd pin of Board to Board Connector1 (J18).
6	I2C0_SCL(PS_MIO10_500)	IO, 1.8V OD/ 4.7K PU	I2C0 Clock. This Pin is connected to 48 th pin of Board to Board Connector2 (J18).
7	NC	NA	NC.
8	UART1_TX(PS_MIO08_500)	O, 1.8V LVCMOS	UART1 Transmit data line. Same pin can be configured as General Purpose Input/Output if required. This Pin is connected to 50 th pin of Board to Board Connector2 (J19).
9	SPIO_SS1(PS_MIO2_500)	O, 1.8V LVCMOS	SPI Chip select 1. Same pin can be configured as General Purpose Input/Output if required. This Pin is connected to 176 rd pin of Board to Board Connector1 (J18).
10	UART1_RX(PS_MIO09_500)	I, 1.8V LVCMOS	UART1 Receive data line. Same pin can be configured as General Purpose Input/Output if required. This Pin is connected to 52 nd pin of Board to Board Connector2 (J19).
11	GND	Power	Ground
12	GND	Power	Ground
13	SPIO_SCLK(PS_MIO0_500)	O, 1.8V LVCMOS	SPI Clock output. Same pin can be configured as General Purpose Input/Output if required. This Pin is connected to 61 st pin of Board to Board Connector2 (J19).
14	NC	NA	NC.
15	SPIO_SS0(PS_MIO3_500)	O, 1.8V LVCMOS	SPI Chip select 0. This Pin is connected to 63 rd pin of Board to Board Connector2 (J19).
16	NC	NA	NC.
17	SPIO_MOSI(PS_MIO5_500)	IO, 1.8V LVCMOS	SPI Master output Slave input. Same pin can be configured as General Purpose Input/Output if required. This Pin is connected to 65 th pin of Board to Board Connector2 (J19).
18	SPIO_MISO(PS_MIO4_500)	IO, 1.8V LVCMOS	SPI Master input Slave output. Same pin can be configured as General Purpose Input/Output if required. This Pin is connected to 67 th pin of Board to Board Connector2 (J19).
19	GND	Power	Ground
20	GND	Power	Ground

2.6.6 Power ON/OFF Switch

The Zynq Ultrascale+ MPSoC Carrier board has power ON/OFF switch (SW2) to control the Main power Input ON/OFF functionality. This power ON/OFF switch is physically located at the top of the board as shown below.

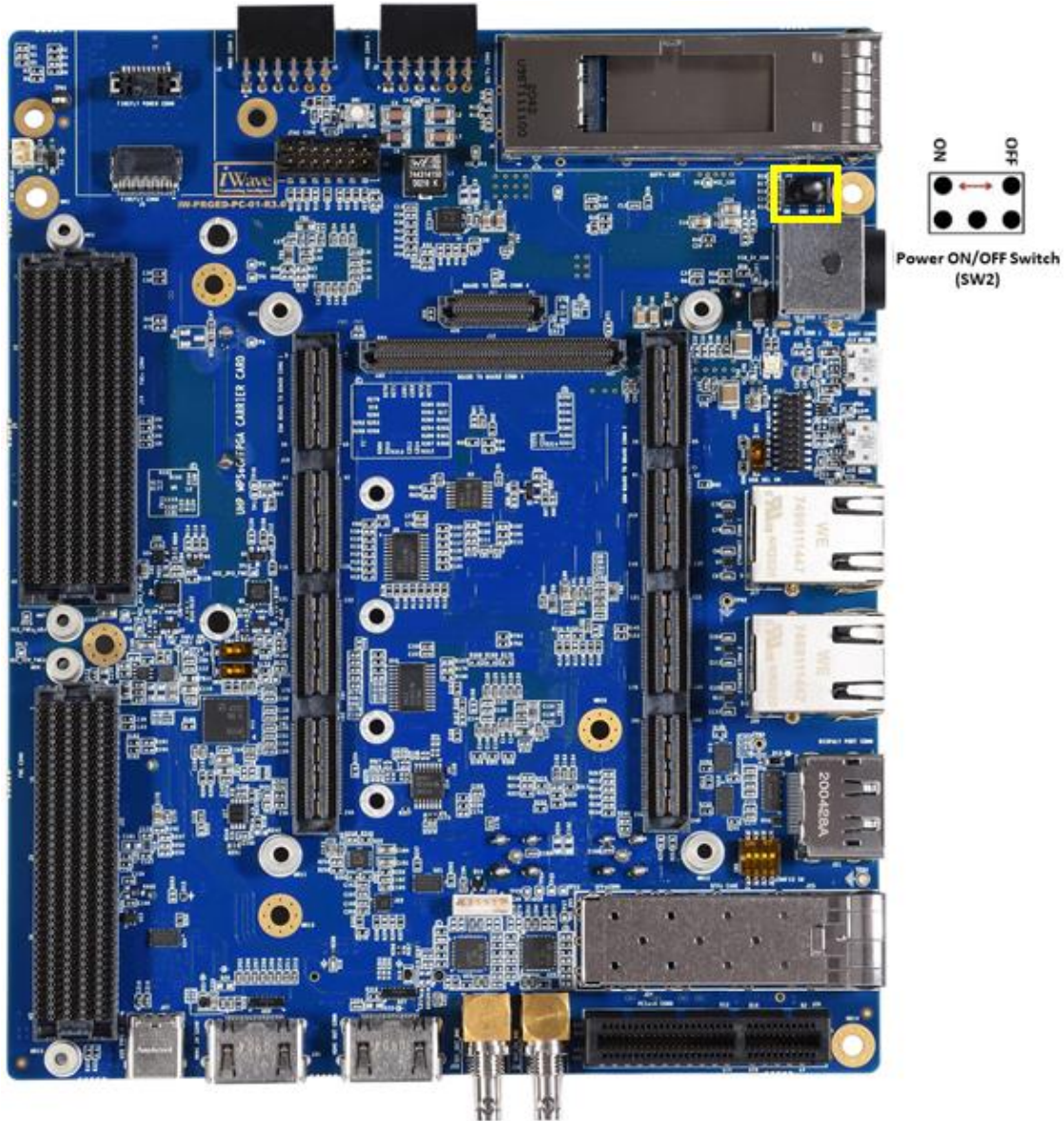

Figure 35: Power On/Off Switch

2.6.7 Reset Switch

The Zynq Ultrascale+ MPSoC (ZU11/17/19EG) Carrier board supports Push button switch (SW1) to reset the Zynq Ultrascale+ MPSoC (ZU11/17/19EG) CPU. Reset signal of Board to Board connector2 Pin 35 is directly connected from Reset Push button switch. This Reset Push button switch (SW1) is physically located at the top of the board as shown below.

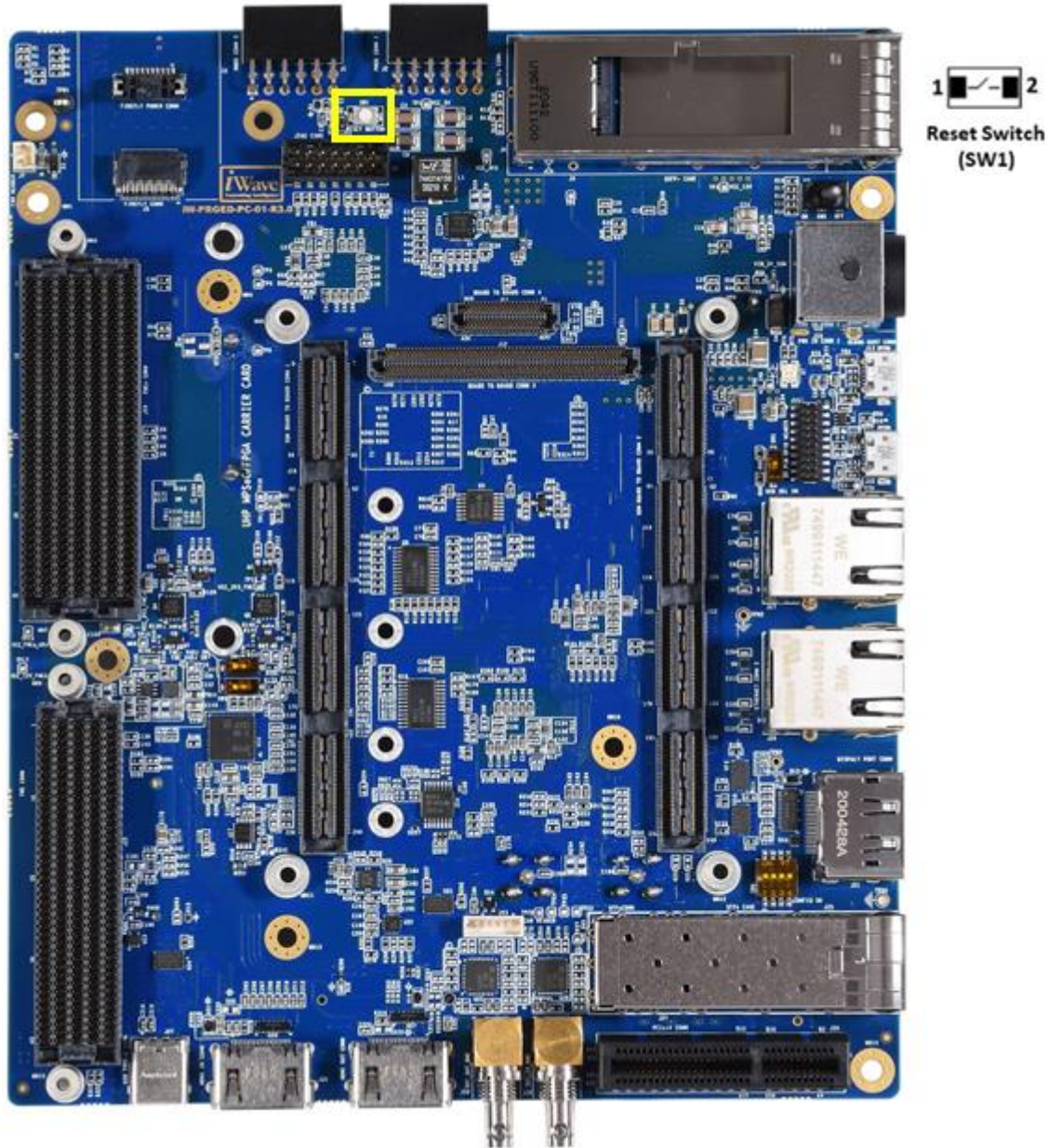

Figure 36: Reset Switch

2.6.8 RTC Coin Cell Holder

The Zynq Ultrascale+ MPSoC (ZU11/17/19EG) Carrier board supports Coin Cell Holder to connect “2032” series 3V coin cell. This coin cell voltage is connected to Zynq Ultrascale+ MPSoC (ZU11/17/19EG) SOM for RTC back up voltage when VCC main power is off. This Coin Cell Holder (J32) is physically located at the bottom of the board as shown below.

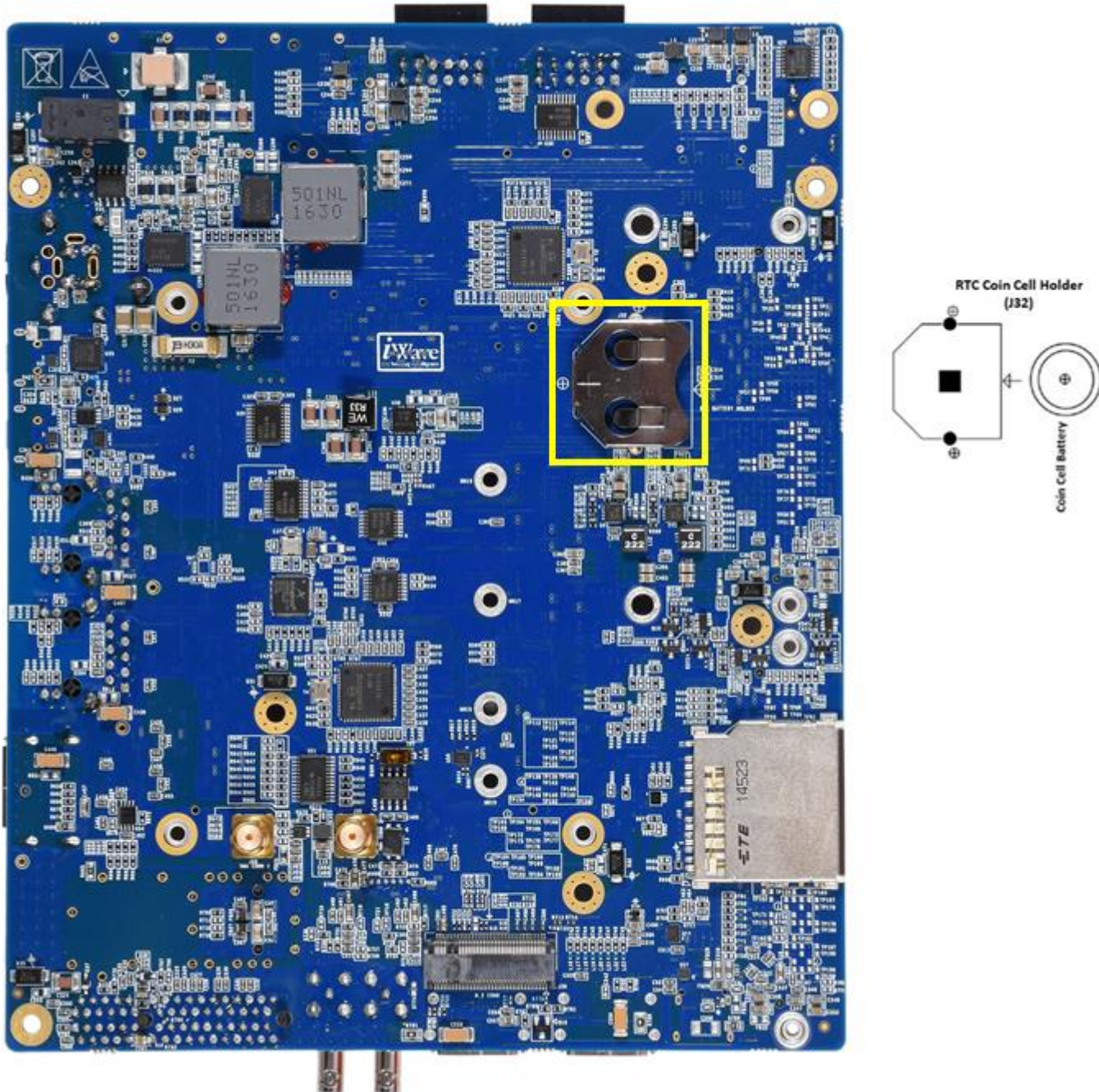

Figure 37: RTC Coin Cell Holder

2.6.9 12V Fan Header

The Zynq Ultrascale+ MPSoC (ZU11/17/19EG) Carrier Board supports a 12-Fan Header (J7) to connect cooling Fan if required. The Fan Header (J7) is physically located on topside of the carrier board as shown below.

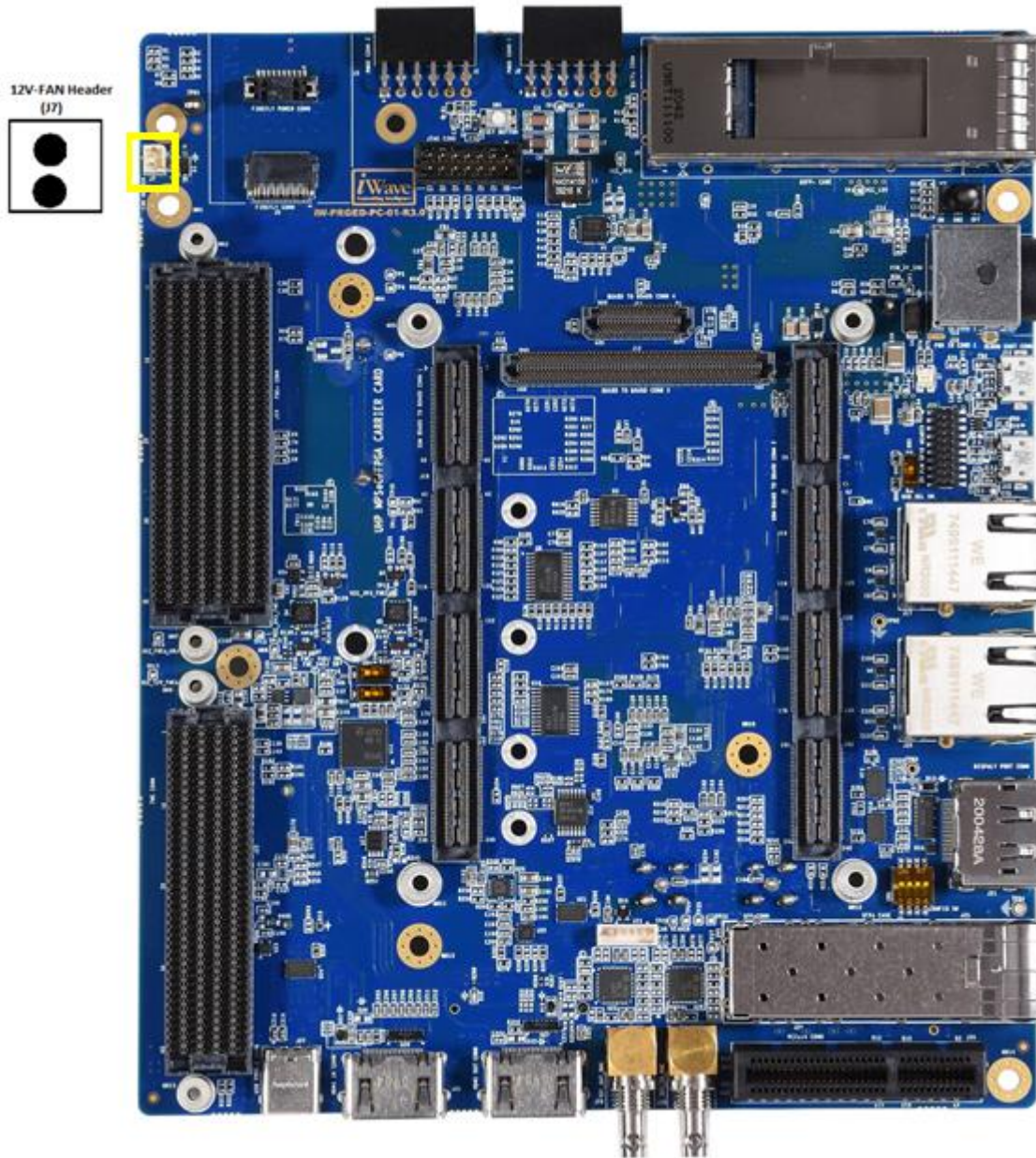

Figure 38: 12V-Fan Header

Table 25: 12V Fan Header Pinout

Sl. No.	Power Rail	Signal Type/ Termination	Description
1	VCC_12V ¹	O, 12V Power	Supply Voltage.
2	GND	Power	Ground.

¹ Do not connect the SOM Heat Sink Fan to 12V FAN Connector in Carrier board. By Default iW-RainboW-G35D Zynq Ultrascale+ MPSoC (ZU11/17/19EG) SOM Development platform comes with Heat Sink + Fan mounted on SOM itself.

3. TECHNICAL SPECIFICATION

This section provides detailed information about the Zynq Ultrascale+ MPSoC (ZU11/17/19EG) Carrier Board technical specification with Electrical, Environmental and Mechanical characteristics.

3.1 Power Input Requirement

The Zynq Ultrascale+ MPSoC (ZU11/17/19EG) Carrier Board is designed to work with 12V external power and uses on board voltage regulators for internal power management. 12V power input from an external power supply is connected to the Zynq Ultrascale+ MPSoC (ZU11/17/19EG) Carrier Board through Power Jack (J10). This connector is physically placed at the top of the board as shown below.

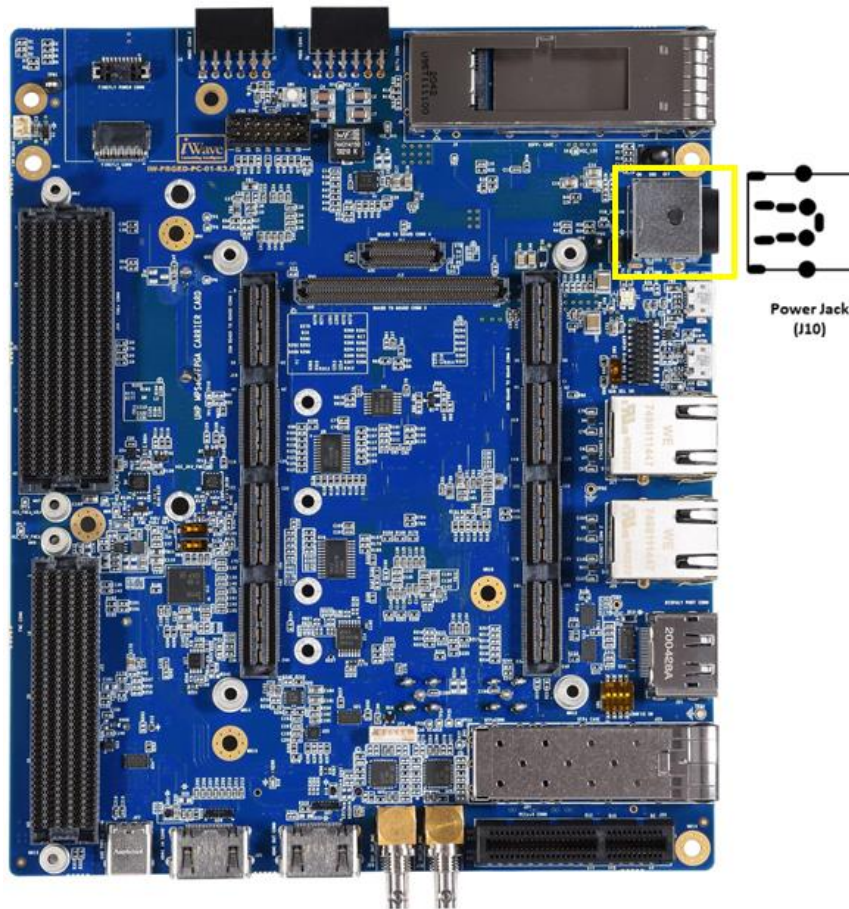

Figure 39: Power Jack

The below table provides the Power Input Requirement Zynq Ultrascale+ MPSoC (ZU11/17/19EG) Carrier Board.

Table 26: Power Input Requirement

Sl. No.	Power Rail	Min (V)	Typical (V)	Max(V)	Max Input Ripple
1	VCC_12V	11.75V	12V	12.25V	±50mV
2	VRTC_3V0 ¹	0	3V	3.15V	±20mV

¹ The Zynq Ultrascale+ MPSoC (ZU11/17/19EG) DevKit uses this voltage as backup power source to On-SOM PMIC RTC controller when VCC is off.

3.2 Power Output Specification

The Zynq Ultrascale+ MPSoC (ZU11/17/19EG) Carrier Board has dedicated power regulator to provide +5V power to SOM for VCC power supply. Also +3V RTC power from coin cell holder is provided for Real time clock support.

The Zynq Ultrascale+ MPSoC (ZU11/17/19EG) Carrier Board also shares different on-board power to FMC connectors, Pmod connectors and GPIO Header for its Add-On Module power.

Table 27: Power Output Specification

Sl. No.	Power Rail	Min (V)	Typical (V)	Max(V)	Max Output Current
To Board to Board Connector2 (for Zynq Ultrascale+ MPSoC SOM)					
1	VCC_5V	4.85V	5V	5.15V	40A
2	VRTC_3V0	0V	3V	3.15V	-
To FMC Connector					
1	VCC_FMC_ADJ	1.75	1.8	1.85	4A
2	VCC_3V3	3.15	3.3	3.45	3A
3	3P3VAUX	3.15	3.3	3.45	100mA
4	VCC_12V	11.75V	12V	12.25V	1A
To FMC+ Connector					
1	VCC_FMC_ADJ	1.75	1.8	1.85	4A
2	VCC_3V3	3.15	3.3	3.45	3A
3	3P3VAUX	3.15	3.3	3.45	100mA
4	VCC_12V	11.75V	12V	12.25V	1A
To Pmod Connector1					
1	VCC_3V3	3.15	3.3	3.45	500mA
To Pmod Connector2					
1	VCC_3V3	3.15	3.3	3.45	500mA
To GPIO Header					
1	VCC_5V	3.15	3.3	3.45	500mA
2	VCC_1V8	1.75	1.8	1.85	200mA

3.3 Environmental Characteristics

3.3.1 Environmental Specification

The below table provides the Environment specification of Zynq Ultrascale+ MPSoC (ZU11/17/19EG) Development platform.

Table 28: Environmental Specification

Parameters	Min	Max
Operating temperature range ¹	0°C	70°C

¹ iWave only guarantees the component selection for the given operating temperature.

3.3.2 RoHS Compliance

iWave's Zynq Ultrascale+ MPSoC (ZU11/17/19EG) Development platform is designed by using RoHS compliant components and manufactured on lead free production process.

3.3.3 Electrostatic Discharge

iWave's Zynq Ultrascale+ MPSoC (ZU11/17/19EG) Development platform is sensitive to electro static discharge and so high voltages caused by static electricity could damage some of the devices on board. It is packed with necessary protection while shipping. Do not open or use board except at an electrostatic free workstation.

3.4 Mechanical Characteristics

3.4.1 Carrier Board Mechanical Dimensions

The Ultra-High-Performance Carrier board PCB form factor is 140mm x 170mm and Board mechanical dimension is shown below.

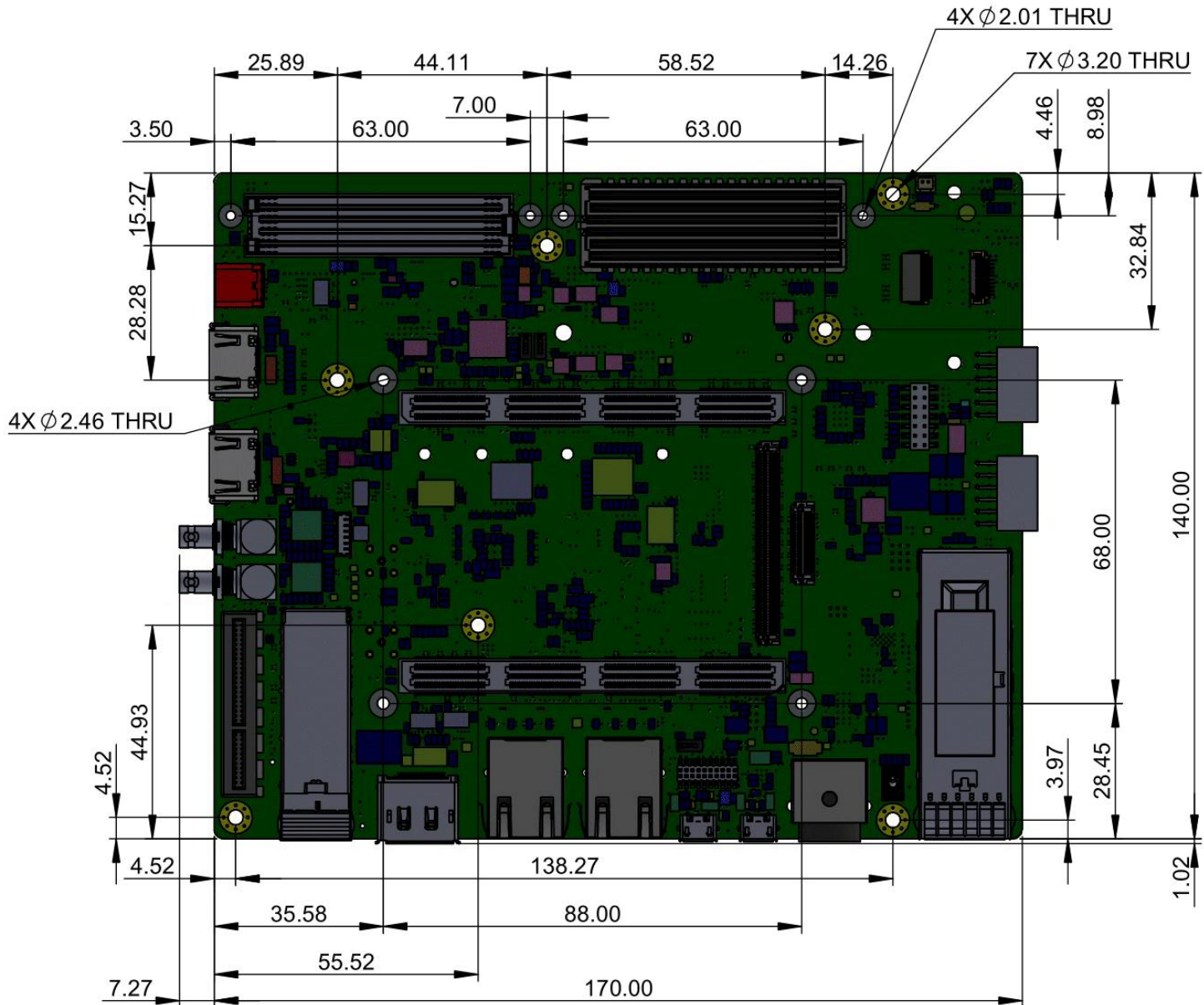

Figure 40: Carrier board Mechanical dimension – Top View

The Ultra-High-Performance Carrier board PCB thickness is $1.55\text{mm} \pm 0.1\text{mm}$, top side maximum height component is Ethernet Magjack Connector (15.00mm) and bottom side maximum height component is SMA Connector (9.55mm). Please refer the below figure for height details of the Zynq Ultrascale+ MPSoC (ZU11/17/19EG) Carrier board.

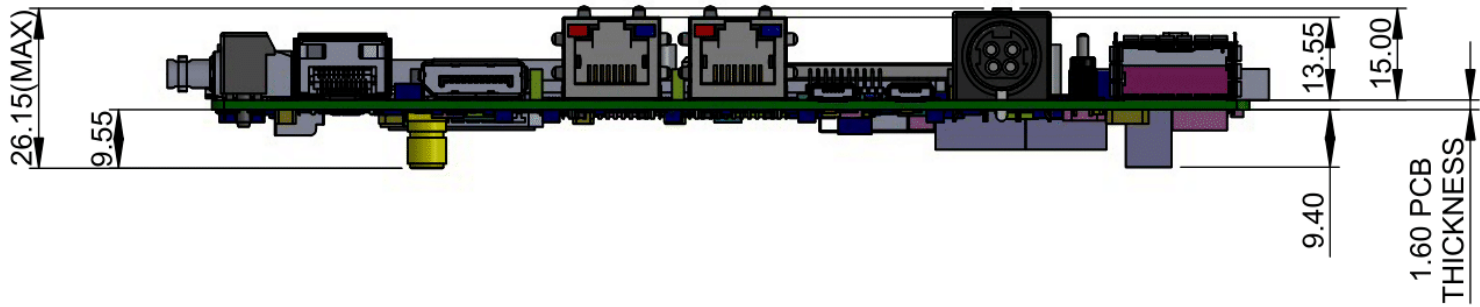

Figure 41: Carrier board Mechanical dimension – Side View

3.4.2 Guidelines to insert the Zynq Ultrascale+ SoC SOM into Carrier Board

- Make sure the power is not provided to the carrier Board
- Insert the Zynq Ultrascale+ SoC SOM in to the Board to Board(B2B) as shown below in the first photo
- Check the position of B2B1, B2B2, B2B3 and B2B4 of Zynq Ultrascale+ SOM is proper while inserting
- Press the SOM in to B2B connectors as shown below in the first photo such that the board is fixed firmly into the B2B connectors
- To remove the SOM from carrier board, Lift the SOM as shown in the second photo

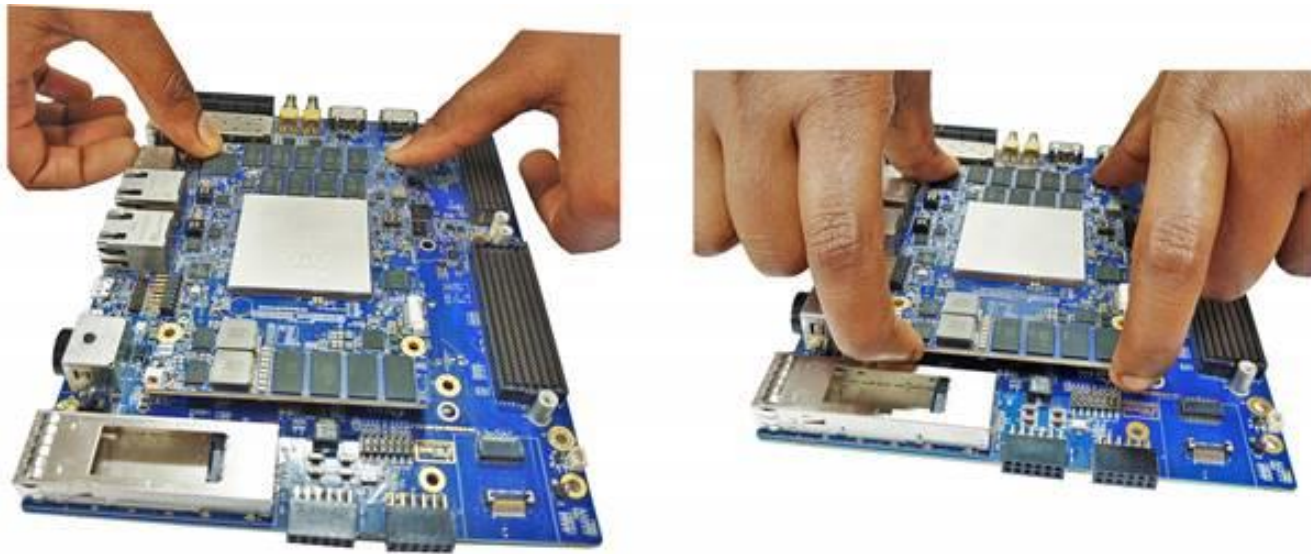

Figure 42: Zynq Ultrascale+ SoC SOM Inserting Procedure

3.4.3 FAN Sink Fixing procedure on SOM with Carrier Board

The Ultra-High-Performance Carrier board and Zynq Ultrascale+ SOM with Fan sink fixing procedure is shown below.

iW-RainboW-G35M
ZU19/17/11 Zynq UltraScale+ MPSoC FPGA SOM Fan Sink
ASSEMBLY INSTRUCTIONS

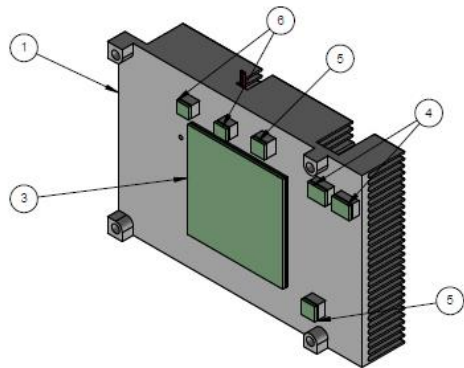

Fig 1.2

NOTE 1.1:

CAUTION:-

1. ASSEMBLY MUST BE DONE VERY CAREFULLY SINCE PUTTING THE FAN SINK IN A WRONG WAY AND OVER TIGHTENING OF SCREWS WILL DAMAGE THE SOM MODULE OR PREVENT THE SYSTEM FROM WORKING PROPERLY.
2. FOLLOW THE ASSEMBLY INSTRUCTIONS (NOTE 1.2) CAREFULLY TO ENSURE THAT THE MODULE DOES NOT GET DAMAGED.
3. NECESSARY PRECAUTIONS SHOULD BE TAKEN CARE TO AVOID THE ELECTROSTATIC CHARGES.

NOTE 1.2:

FAN SINK ASSEMBLY INSTRUCTIONS: -

1. CLEAN THE PROCESSOR SURFACE.
2. PEEL OFF THE LINER PRESENT ON THE THERMAL PAD.
3. GENTLY PLACE THE FAN SINK ON SOM MODULE.
4. MAKE SURE THAT SOM MODULE AND FAN SINK MOUNTING HOLES ARE ALIGNED.
5. MOUNT THE ASSEMBLED FAN SINK AND SOM ON THE CARRIER CARD SPACERS.
6. AFTER ASSEMBLING MAKE SURE ALL THE SOM MOUNTING HOLES ARE ALIGNED WITH CARRIER CARD SPACERS.
7. PUT THE SCREWS FROM TOP OF THE FAN SINK AND TIGHTEN THEM TO HAND TIGHT(REFER Fig1.1).

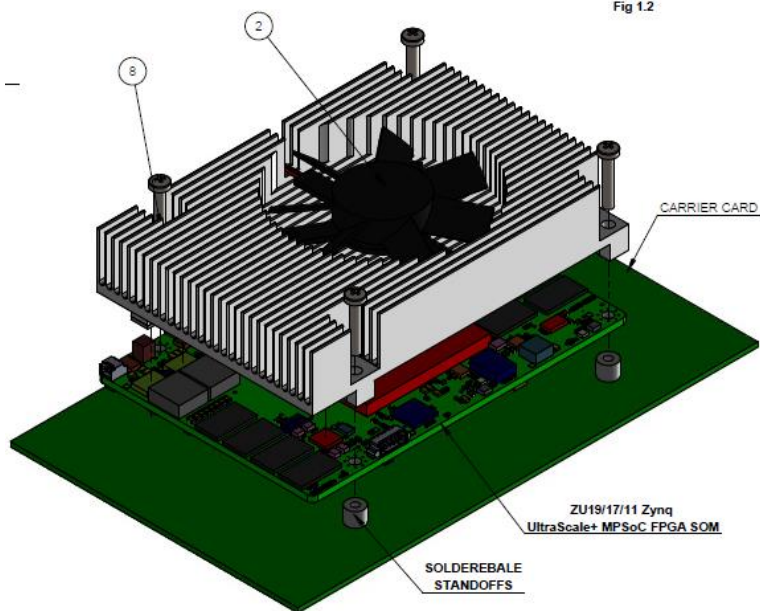

Fig 1.1

ITEM NO.	PART NUMBER	DESCRIPTION	MATERIAL	
1	iW-PRGBZ-MP-01-R1.0-REL1.0-FSK01	FAN SINK FOR FPGA/SoC SOM	AL 6063-T5 ALLOY	1
2	T056010BHZC0U3aR	80mm FAN (COMES ASSEMBLED WITH FANSINK)	PBT(BLACK) PLASTIC	1
3	TG-A1250-43-43-1	1.0mm THICK THERMAL PAD	SILICONE RUBBER (SIR)	1
4	TG-A1250-8-8-1	1.0mm THICK THERMAL PAD	SILICONE RUBBER (SIR)	2
5	TG-A1250-8-8-1	1.0mm THICK THERMAL PAD	SILICONE RUBBER (SIR)	2
6	TG-A1250-5.4-5-1	1.0mm THICK THERMAL PAD	SILICONE RUBBER (SIR)	2
7	LABEL-30X10	LABEL FOR PRODUCTION LOT PART NUMBER	STICKER	1
8	M3X16 PAN PHILLIPS DIN 7985	SCREW	SS 304	4

TABLE 1.1: BOM

Figure 43: Zynq Ultrascale+ SOM with Fan sink fixing procedure

4. ORDERING INFORMATION

The below table provides the standard orderable part numbers for Zynq Ultrascale+ MPSoC (ZU11/17/19EG) Development platform which includes Zynq Ultrascale+ MPSoC (ZU11/17/19EG) SOM and Carrier Board.

Table 29: Orderable Product Part Numbers

Product Part Number	Description	Temperature
ZU19EG-1 MPSoC SOM based Development Platform		
iW-G35D-19EG-4E004G-E008G-LCG	ZU19EG (-1) MPSoC, 4GB PS DDR4 with ECC, Dual 4GB PL DDR4, 8GB EMMC - Development kit with Linux	Commercial
ZU17EG-1 MPSoC SOM based Development Platform		
iW-G35D-17EG-4E004G-E008G-LCG	ZU17EG (-1) MPSoC, 4GB PS DDR4 with ECC, Dual 4GB PL DDR4, 8GB EMMC - Development kit with Linux	Commercial
ZU11EG-1 MPSoC SOM based Development Platform		
iW-G35D-11EG-4E004G-E008G-LCG	ZU11EG (-1) MPSoC, 4GB PS DDR4 with ECC, Dual 4GB PL DDR4, 8GB EMMC- Development kit with Linux	Commercial
ZU19EG-2 MPSoC SOM based Development Platform		
iW-G35D-19EG-4E004G-E008G-LCF	ZU19EG (-2) MPSoC, 4GB PS DDR4 with ECC, Dual 4GB PL DDR4, 8GB EMMC- Development kit with Linux	Commercial
ZU19EG-3 MPSoC SOM based Development Platform		
iW-G35D-19EG-4E004G-E008G-LCE	ZU19EG (-3) MPSoC, 4GB PS DDR4 with ECC, Dual 4GB PL DDR4, 8GB EMMC - Development kit with Linux	Commercial

Note: For Development platform identification purpose, Product part number is pasted as Label with Barcode readable format.

