

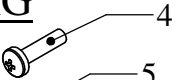

- SCREW BAG**
- 2x- M2 x 8 SCREW 
 - 2x- M2 NUT 



| ITEM NO. | PART NUMBER | DESCRIPTION | QTY. |
|----------|----------------------------------|----------------------|------|
| 1 | iW-PREPZ-MP-01-R2.0-REL1.1-HS001 | SODIMM HEAT SPREADER | 1 |
| 2 | TIM-23mm x 23mm | THERMAL PAD | 1 |
| 3 | TIM-8mm x 8mm | THERMAL PAD | 1 |
| 4 | M2 x8 X REC PAN HEAD SCREW | SCREW | 2 |
| 5 | M2 NUT | NUT | 2 |
| 6 | LABEL | LABEL | 1 |

| | | |
|--|---------|--|
| DRAWN BY | ADARSHA |  iWave Embedding Intelligence iWave System Technologies Private Limited, 7/B, 29th Main, BTM Layout, 2nd Stage, Bangalore-560076, India. |
| CHECKED BY | ADARSHA | |
| APPROVED BY | PRADAP | |
| THIS DRAWING SHEET IS PROPERITORY OF iWAVE SYSTEMS TECHNOLOGIES Pvt. Ltd. | | DRAWING NO: iW-HSPALU-CLASLR-SSxx-R2.0-REL1.1 |
| MATERIAL : AS PER LIST | | WEIGHT: - - - - In grams. |
| FINISH : - - - - | | SUR AREA: - - - - In sqr.mm |
| TITLE: SODIMM HEAT SPREADER | | REV: 2.0 REL: 1.1 |
| DATE : 23/08/2017 | | SHEET 1 OF 2 |

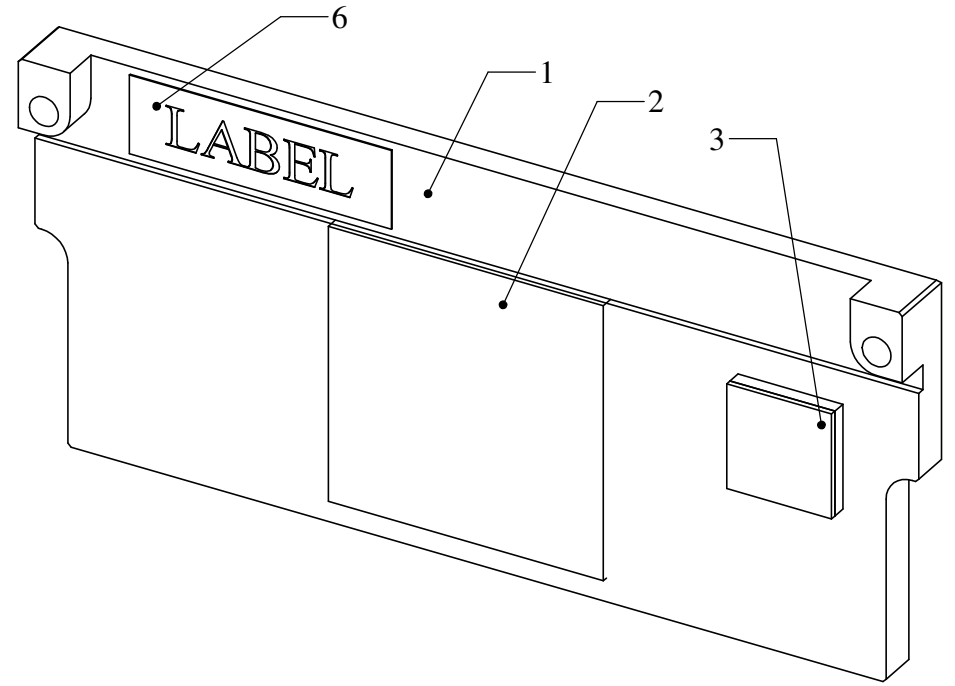
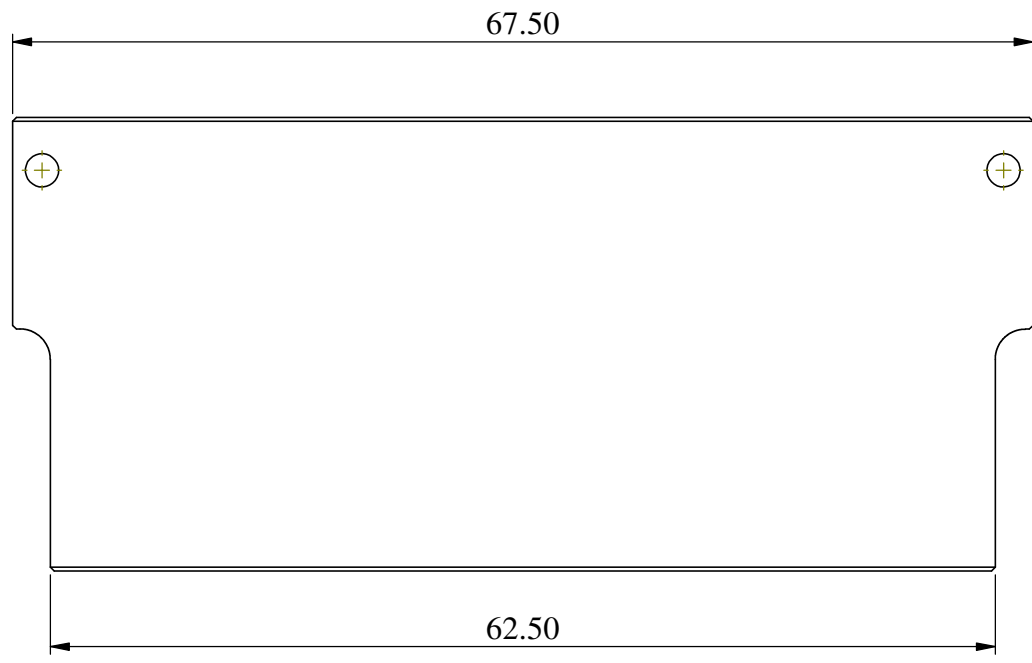
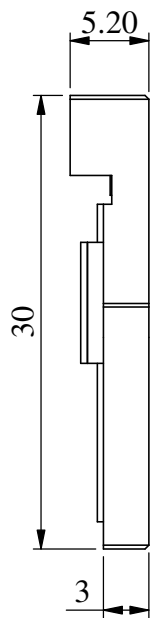
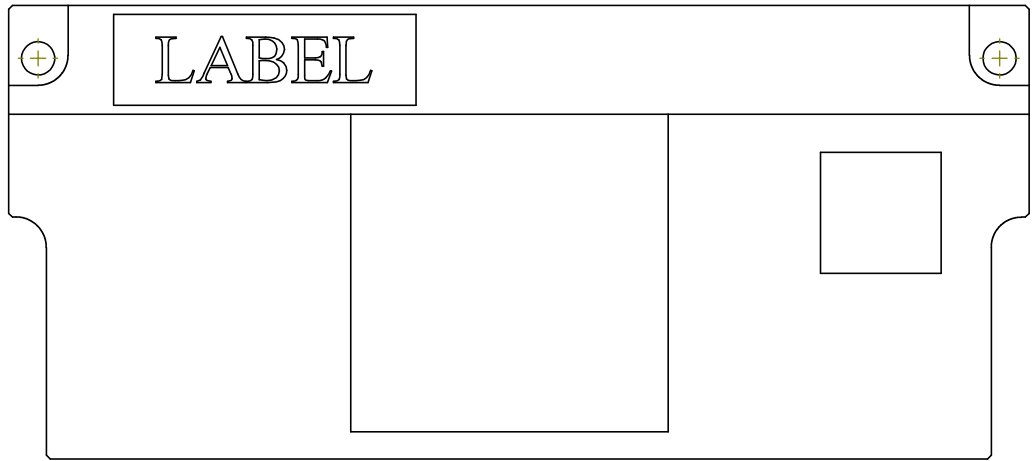
NOTES:
 ALL DIMENSIONS ARE IN MM.
 ROUND OFF ALL SHARP EDGES.
 SCALE: 2:1

GENARALTOLERANCES :
 X: ± 0.25
 .X: ± 0.1
 .XX: ± 0.01

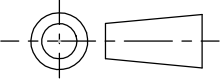

AVAILABLE SODIMM HEAT SPREADER PART NUMBERS

| SL No. | PRODUCT PART No. | DESCRIPTION | THERMAL GAP PAD | REMARKS |
|--------|-----------------------|---|--------------------|---------|
| 01 | iW-HSPALU-CLASLR-SS01 | Non Lidded i.MX6 SODIMM SOM HEAT SPREADER | 1.0mm Si ELASTOMER | - |
| 02 | iW-HSPALU-CLASLR-SS02 | Lidded i.MX6 SODIMM SOM HEAT SPREADER | 0.5mm Si ELASTOMER | - |

A
B
C
D
E
F

A
B
C
D
E
F

| | | | | |
|---|---------|------------------------|---|--|
| DRAWN BY | ADARSHA | | iWave System Technologies Private Limited, 7/B, 29th Main, BTM Layout, 2nd Stage, Bangalore-560076, India. | |
| CHECKED BY | ADARSHA | | | |
| APPROVED BY | PRADAP | | DRAWING NO: iW-HSPALU-CLASLR-SSxx-R2.0-REL1.1 | |
| THIS DRAWING SHEET IS PROPERITORY OF iWAVE SYSTEMS TECHNOLOGIES Pvt. Ltd. | | MATERIAL : AS PER LIST | | WEIGHT: - - - - In grams. |
| GENARALTOLERANCES : X: ± 0.25 .X: ± 0.1 .XX: ± 0.01 | | FINISH : - - - - | | SUR AREA:- - - - In sqr.mm |
| NOTES: ALL DIMENSIONS ARE IN MM. ROUND OFF ALL SHARP EDGES. SCALE: - - | | | | TITLE: SODIMM HEAT SPREADER REV: 2.0 REL: 1.1 |
| | | DATE : 23/08/2017 | | SHEET 2 OF 2 |